

# FT6041

Instruction Manual

# EARTH TESTER



Check for the latest edition and other language versions.



Read carefully before use.  
Keep for future reference.

✓ **When using the instrument for the first time**

- Safety Information ▶ p. 14
- Part Names and Functions ▶ p. 23
- Making Measurements ▶ p. 41

📖 **Troubleshooting**

- Troubleshooting ▶ p. 120
- Messages ▶ p. 123

EN

Nov. 2025 Revised edition 2  
FT6041A961-02





# Contents

Introduction.....	7
Checking Package Contents.....	8
Optional Equipment (Sold Separately).....	9
Symbols and Abbreviations.....	12
Safety Information.....	14
Precautions for Use.....	17

## **1 Overview 21**

1.1 Product Overview.....	21
1.2 Features.....	21
1.3 Part Names and Functions.....	23
FT6041 main unit.....	23
FT9847 Signal Induction Clamp, CT9848 Clamp on Sensor.....	29

## **2 Preparing for Measurement 31**

2.1 How to Use the Carrying Case.....	31
2.2 Inserting/Replacing Batteries.....	32
2.3 Connecting the Z3210 Wireless Adapter.....	35
2.4 How to use the L9846 Earth Nets Module.....	37
2.5 If the Instrument Is Splashed with Water.....	39
In case of condensation.....	40

## **3 Making Measurements 41**

3.1 Measurement Procedure.....	45
3.2 Inspecting the Instrument Before Measurements.....	46
3.3 Measurement Function List.....	49
3.4 Defining the Measurement Conditions.....	50
Setting the voltage.....	50
Setting the measurement frequency.....	50
Setting the distance.....	50
3.5 Measuring Earth Resistance (Three-Pole Measurement).....	51
Making measurements.....	53

- 3.6 Measuring Earth Resistance  
(Three-Pole MEC Measurement)..... 55  
Making measurements..... 55
- 3.7 Measuring Ground resistivity  
(Four-Pole Measurement)..... 57  
Setting the distance..... 57  
Changing the unit of length ..... 58  
Making measurements..... 58
- 3.8 Measuring Earth Resistance  
(Four-Pole MEC Measurement)..... 60  
Making measurements..... 60
- 3.9 Measuring Earth Resistance  
(Two-Clamp Measurement) ..... 62  
Making measurements..... 62
- 3.10 Measuring Earth Resistance Using a Simple Method  
(Two-Pole Measurement)..... 64  
Making measurements..... 66
- 3.11 Measuring Low Resistance  
(Two-Terminal Measurement) ..... 68  
Making measurements..... 68
- 3.12 Measuring Low Resistance  
(Four-Terminal Measurement) ..... 71  
Making measurements..... 71
- 3.13 When the **[NOISE]** Symbol Appears..... 74
- 3.14 Measuring the Ground Potential ..... 75
- 3.15 If a Terminal Symbol Blinks..... 76
- 3.16 Clearing Up the Product After Measurement ..... 78  
How to pull out the auxiliary earthing rods ..... 79

**4 Various Capabilities 81**

---

- 4.1 Continuous Measurement Capability ..... 81  
To enable the continuous measurement capability ..... 81  
To turn the continuous measurement capability off..... 81
- 4.2 Zero-Adjustment Capability..... 82  
How to cancel the previous zero adjustment ..... 83  
If an error is displayed..... 83

4.3	Setting Up the Comparator and Defining the Measurement Conditions .....	84
	To turn the comparator off .....	85
4.4	Power-Saving Capability (Auto-Power Saving Mode).....	86
	How to return the instrument from auto-power saving mode.....	86
	How to turn the power-saving capability off .....	86
	Automatic backlight-off capability.....	86
4.5	Wireless Communications Capability (GENNECT Cross).....	87
4.6	Z3210-to-Excel Direct Data Entry Function (Excel Direct Input Function, HID Function).....	89
	Turning the HID function on and off .....	89
	Confirming the HID setting .....	90
4.7	Displaying All Segments on the Display.....	91
4.8	Displaying the Serial Number .....	91
4.9	Displaying the Firmware Version Number.....	92
	Firmware updating capability .....	92

## **5 Specifications 93**

5.1	General Specifications .....	93
5.2	Input, Output, and Measurement Specifications .....	95
	Basic and accuracy specifications .....	95
	Earth-resistance measurement (four-pole measurement, three-pole measurement, two-pole measurement).....	97
	MEC function (four-pole measurement using a clamp, three-pole measurement using a clamp).....	102
	Two-clamp earth-resistance measurement.....	104
	Low-resistance measurement.....	106
	Ground-potential measurement .....	107
5.3	Capability Specifications .....	108
	Factory default settings and setting backup.....	114
5.4	Specifications of Optional Equipment .....	115
	FT9847 Signal Induction Clamp.....	115
	CT9848 Clamp on Sensor.....	115

**6 Maintenance and Service 117**

---

- 6.1 Repair, Inspection, and Cleaning ..... 117
  - Cleaning ..... 118
  - Limited-life parts and consumables..... 119
  - Disposing of the instrument..... 119
- 6.2 Troubleshooting ..... 120
  - Before returning the instrument for repair ..... 120
- 6.3 Messages..... 123
- 6.4 Replacing the Fuse ..... 124

**7 Appendix 127**

---

- 7.1 Earth Resistance..... 127
- 7.2 Measurement Principle ..... 128
  - Measurement of earth resistance..... 128
  - Two-clamp measurement..... 129
  - Low-resistance measurement..... 129
- 7.3 Tips on the Three-pole Measurement ..... 130
  - Distance between earth electrodes..... 130
  - Locations to drive the auxiliary earthing rods..... 131
  - How to insert the auxiliary earthing rods ..... 132

**Index 133**

---

**Warranty Certificate**

---

## Introduction

Thank you for choosing the Hioki FT6041 Earth Tester. To ensure that you get the most out of this instrument over the long term, please read this manual carefully and keep it available for future reference.

Please review the separate *Operating Precautions* before using this instrument.

### Information on download site

For details on the product application, the update file for the instrument, and the instruction manual, please check Hioki's website:

<https://cloud.gennect.net/d/>

An ISO file is a CD or DVD image file. When double-clicked, it will be recognized as a drive and become available for use.



### Request for product user registration

Please register this product so that you can receive important information regarding the product.

<https://www.hioki.com/global/support/myhioki/registration/>



### Target audience

This manual has been written for use by individuals who use the instrument or provide information about how to use the product. In explaining how to use the product, it assumes electrical knowledge (equivalent of the knowledge possessed by a graduate of an electrical program at a technical high school).

### Trademarks

- Excel is a trademark of the Microsoft group of companies.
- The Bluetooth® word mark and logos are registered trademarks owned by Bluetooth SIG, Inc. and any use of such marks by Hioki E.E. Corporation is under license. Other trademarks and trade names are those of their respective owners.

## Checking Package Contents

When you receive the product, inspect them to ensure that no damage occurred during shipment. If you find any damage or discover that the product does not perform as indicated in the specifications, please contact your authorized Hioki distributor or reseller.

Check whether the packing contents are correct.

- FT6041 Earth Tester (covered with the protector)

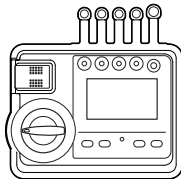

- L9840 Auxiliary Earthing Rod (with a loop at one end, a set of two) ×2
- L9841 Measurement Cable (crocodile clip, black, cable length: 4 m)
- L9845-31 Measurement Cable (yellow, cable length: 25 m, coming with a winder)
- L9845-33 Measurement Cable (blue, cable length: 25 m, coming with a winder)
- L9845-52 Measurement Cable (red, cable length: 50 m, coming with a winder)
- L9846 Earth Nets Module ×2 (inserted in L9845-31 and L9845-52)
- L9787 Test Lead (for two-pole measurement)
- C0208 Carrying Case (for containing the instrument and clamps)
- C0209 Carrying Case (for containing the measurement cables)
- LR6 Alkaline battery ×4
- Instruction Manual (Please visit Hioki's website to check for versions in other languages.)
- Operating Precautions (0990A907)







The following products are supplied with the FT6041-91 only:

- FT9847 Signal Induction Clamp (for injecting measurement signals)
- Operation-check resistor (25 Ω ±1%, for FT9847)
- CT9848 Clamp on Sensor (for detecting measurement signals)

## Optional Equipment (Sold Separately)

The optional equipment listed below is available for the instrument. To purchase optional equipment, please contact your authorized Hioki distributor or reseller. Optional equipment is subject to change with no advance notice. Check Hioki's website for the latest information.

<b>FT9847</b>	<b>Signal Induction Clamp</b> For injecting measurement signals during two-clamp measurements, cable length: 2 m	
<b>CT9848</b>	<b>Clamp on Sensor</b> For detecting measurement signals during two-clamp measurements and MEC measurements, cable length: 2 m	
<b>Z3210</b>	<b>Wireless Adapter</b> For wireless communications	
<b>L9840</b>	<b>Auxiliary Earthing Rod</b> With a loop at one end, a set of two	
<b>L9841</b>	<b>Measurement Cable</b> Crocodile clip, black, cable length: 4 m, rated voltage: 50 V	
<b>L9842-11</b>	<b>Measurement Cable</b> Yellow, cable length: 10 m, coming with a winder, rated voltage: 50 V	
<b>L9842-22</b>	<b>Measurement Cable</b> Red, cable length: 20 m, coming with a winder, rated voltage: 50 V	 L9842-11
<b>L9845-31</b>	<b>Measurement Cable</b> Yellow, cable length: 25 m, coming with a winder, rated voltage: 50 V	
<b>L9845-33</b>	<b>Measurement Cable</b> Blue, cable length: 25 m, coming with a winder, rated voltage: 50 V	
<b>L9845-52</b>	<b>Measurement Cable</b> Red, cable length: 50 m, coming with a winder, rated voltage: 50 V	 L9845-31

<p><b>L9846</b></p>	<p><b>Earth Nets Module</b></p> <p>For L9845-31, L9845-33, and L9845-52                  When retracted: approx. 206W × 229H × 95D mm                  When extended: approx. 414W × 229H × 78D mm</p>	
<p><b>L9843-51</b></p>	<p><b>Measurement Cable</b></p> <p>Yellow, cable length: 50 m, coming with a cable-winding plate, rated voltage: 50 V</p>	
<p><b>L9843-52</b></p>	<p><b>Measurement Cable</b></p> <p>Red, cable length: 50 m, coming with a cable-winding plate, rated voltage: 50 V</p>	<p>L9843-51</p>
<p><b>L9844</b></p>	<p><b>Measurement Cable</b></p> <p>For ground terminal boards, crocodile clips, a set of three cables (red, yellow, black; cable length: 1.2 m each)                  Maximum rated line-to-ground voltage                  1000 V, measurement category III, anticipated transient overvoltage: 8000 V                  600 V, measurement category IV, anticipated transient overvoltage: 8000 V                  Maximum rated current: 10 A</p>	
<p><b>L9787</b></p>	<p><b>Test Lead</b></p> <p>Indoor use, for two-pole measurement, cable length: 1.2 m                  With the sleeves:                  Maximum rated line-to-ground voltage: 600 V, measurement category III                  Anticipated transient overvoltage: 6000 V                  Without the sleeves:                  Maximum rated line-to-ground voltage: 600 V, measurement category II                  Anticipated transient overvoltage: 4000 V                  Maximum rated current: 10 A (continuous)</p>	
<p><b>9772</b></p>	<p><b>Pin Type Lead</b></p> <p>Indoor use, for four-terminal low-resistance measurement, cable length: 1.9 m                  Maximum rated line-to-ground voltage:                  30 V AC rms, 42.4 V AC peak, 60 V DC                  Rated current: 2 AAC/DC (continuous)</p>	
<p><b>9467</b></p>	<p><b>Large Clip Type Lead</b></p> <p>Indoor use, for four-terminal low-resistance measurement, cable length: 1.3 m                  Rated voltage: 60 V DC</p>	
<p><b>9050</b></p>	<p><b>Earth Nets</b></p> <p>A set of two, 300 mm × 300 mm</p>	

---

**C0208**

**Carrying Case**

For containing the instrument and clamps



---

**C0209**

**Carrying Case**

For containing the measurement cables

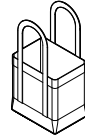

---

**Z5052**

**Fuse Set**







Two pieces

---









## Symbols and Abbreviations

### Safety notations



This manual classifies seriousness of risks and hazard levels as described below.

 <b>DANGER</b>	Indicates an imminently hazardous situation that, if not avoided, will result in death or serious injury.
 <b>WARNING</b>	Indicates a potentially hazardous situation that, if not avoided, could result in death or serious injury.
 <b>CAUTION</b>	Indicates a potentially hazardous situation that, if not avoided, could result in minor or moderate injury or potential risks of damage to the supported product (or to other property).
<b>IMPORTANT</b>	Indicates information or content that is particularly important from the standpoint of operating or maintaining the product.
	Indicates a high-voltage hazard. Failure to verify safety or improper handling of the instrument could lead to an electric shock, burn, or death.
	Indicates a prohibited action.
	Indicates a mandatory action.

### Symbols on the product

	Indicates the presence of a potential hazard. See “Precautions for Use” (p.17) and safety notes listed at the beginning of each operating instruction in the instruction manual, and the accompanying document entitled Operating Precautions.
	Indicates that dangerous voltage may be present at this terminal.
	Indicates that the product can be connected to and disconnected from a live conductor.
	Indicates the product is protected throughout by double insulation or reinforced insulation.
	Indicates a fuse.
	Indicates a ground terminal.
	Indicates that the product can be used for direct current (DC).
	Indicates that the product can be used for alternating current (AC).

## Symbols for various standards

	Indicates that the product is subject to the Directive on Waste Electrical and Electronic Equipment (WEEE) in EU member nations. Dispose of the product by local regulations.
	Indicates that the product complies with standards imposed by EU directives.

## Others

*	Indicates that additional information is described below.
(p. )	Indicates the page number to reference.
[ ]	Indicates the names of user interface elements on the screen.
<b>Fn</b> (Boldface)	Indicates the names of the control buttons.

## Screen display

The instrument screen displays the alphanumeric characters as follows:

A	B	C	D	E	F	G	H	I	J	K	L	M	N	O	P	Q	R	S	T	U	V	W	X	Y	Z
A	b	c	d	e	f	g	h	i	j	k	l	m	n	o	p	q	r	s	t	u	v	w	x	y	z
1	2	3	4	5	6	7	8	9	0																
1	2	3	4	5	6	7	8	9	0																

## Accuracy labeling

The accuracy of the measuring instrument is expressed using a combination of the formats shown below:

- By defining limit values for errors using the same units as measured values.
- By defining limit values for errors as a percentage of the reading, a percentage of the full scale, and in terms of digits.

<b>Reading (displayed value)</b>	Indicates the value displayed by the measuring instrument. Limit values for reading errors are expressed as a percentage of the reading ( <i>% of reading</i> or <i>% rdg</i> ).
<b>Full scale</b>	Indicates the maximum display value or the rated current. Limit values for full-scale errors are expressed as a percentage of the full ( <i>% of full scale</i> or <i>% f.s.</i> ).
<b>Digits (resolution)</b>	Indicates the minimum display unit (in other words, the smallest digit that can have a value of one) for a digital measuring instrument. Limit values for digit errors are expressed using digits ( <i>dgf</i> ).

## Safety Information

This instrument has been designed to conform to the international standard, IEC 61010, and thoroughly tested for safety before shipment. However, using the instrument in a way not described in this manual may negate the provided safety features.

Carefully read the following safety notes before use.

### DANGER

- **Familiarize yourself with the contents of this manual before use.**



Otherwise, the instrument can be misused, resulting in serious bodily injury or damage to the instrument.

### WARNING

- **If you have not previously used electrical measuring instruments, ensure adequate supervision by a technician with experience in electrical measurement.**



Failure to do so could cause the user to experience an electric shock. It could also cause serious events such as heat generation, fire, or arc flash due to a short-circuit fault.

## Protective gear

### WARNING

- **Wear electrically insulating personal protective equipment (PPE).**



Performing measurement using this instrument involves live-line work. Failure to wear PPE could cause the user to experience an electric shock. Wearing PPE is prescribed under applicable laws and regulations.

## Measurement categories

IEC 61010 defines measurement categories to facilitate safe use of measuring instruments. Test and measurement circuits are classified into three categories according to the type of mains to which they are intended to be connected.

### **DANGER**

- **Do not use a measuring instrument with a lower measurement category rating than that determined according to the type of the mains for measurements on mains.**



- **Do not use a measuring instrument without a measurement category rating for measurements on mains.**

Otherwise, the user will suffer from a serious bodily injury or the instrument and the mains installation will be damaged.

---

This instrument has measurement circuits with ratings for CAT II, CAT III, and CAT IV.

**Measurement category II (CAT II)**

Applicable to test and measuring circuits connected directly to utilization points (socket outlets and similar points) of the low-voltage mains installation.

EXAMPLE: Measurements on household appliances, portable tools, and similar equipment, and on the consumer side only of socket-outlets in the fixed installation.

**Measurement category III (CAT III)**

Applicable to test and measuring circuits connected to the distribution part of the building's low-voltage mains installation.

EXAMPLE: Measurements on distribution boards (including secondary meters), photovoltaic panels, circuit breakers, wiring, including cables, bus-bars, junction boxes, switches, socket-outlets in the fixed installation, and equipment for industrial use and some other equipment such as stationary motors with permanent connection to the fixed installation.

**Measurement category IV (CAT IV)**

Applicable to test and measuring circuits connected at the source of the building's low-voltage mains installation.

EXAMPLE: Measurements on devices installed before the main fuse or circuit breaker in the building installation.

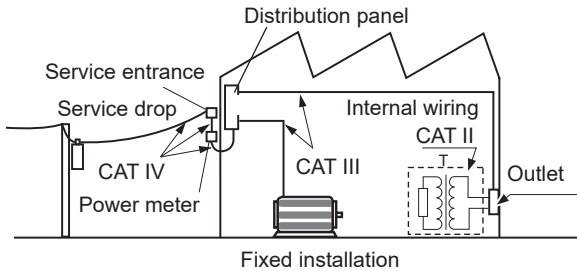

## Precautions for Use

Observe the following precautions to ensure the safe use of the instrument and the effective use of its capabilities.

Use of the instrument should conform not only to its specifications but also to the specifications of all equipment to be used, including accessories, optional equipment, and batteries.

### Handling the instrument

#### WARNING

■ **Do not use the instrument in locations such as the following:**

- In locations where it would be subject to direct sunlight or high temperatures
  - In locations where it would be exposed to corrosive or explosive gases
  - In locations where it would be exposed to powerful electromagnetic radiation or close to objects carrying an electric charge
  - Close to inductive heating devices (such as high-frequency inductive heating devices and IH cooktops)
  - In locations characterized by a large amount of mechanical vibration
  - In locations where it would be exposed to water, oil, chemicals, or solvents
  - In locations where it would be exposed to high humidity or condensation
  - In locations with an excessive amount of dust
  - In locations where it would be unstable or inclined
- Doing so could damage the instrument or cause it to malfunction, resulting in bodily injury.



#### CAUTION

- **Do not subject the instrument to vibration or mechanical shock while transporting or handling it.**



- **Do not drop the instrument.**

Doing so could damage the instrument.

## Shipping precautions

Store the packaging material after unpacking the instrument. Use the original packaging when shipping the instrument.

## Handling the test leads

### **DANGER**



- **Check that the test leads have no damaged insulation or exposed metal before use.**

Using a damaged test lead will lead to serious bodily injury. Replace the test leads with those specified by Hioki.

---

### **WARNING**



- **Do not use the instrument with the optional connection cables connected for measurements that exceed any of the ratings marked on them.**

Using the product for measurements that exceed any ratings could cause the user to experience an electric shock.

---



- **Use only Hioki-specified test leads with the instrument.**

Using an unspecified test lead could result in bodily injury or a short-circuit fault.

---

## CAUTION

- **Do not bend or pull on cables at temperatures of 0°C or lower.**

Cables could harden at low temperatures. Bending or pulling a cable under these conditions could cause a break in the cable or damage the insulation, resulting in an electric shock.



- **Do not route cords between other objects or step on cords.**
- **Do not bend, pull on, or twist cables and strain reliefs excessively.**

Doing so could cause a wire break.

- 
- **Pull the connectors to remove the measurement cables and test leads from the instrument.**



Pulling the cables could cause a break in measurement cables or test leads.

### Precautions during measurement

## DANGER

- **Do not use the instrument for measurements on circuits that exceed the ratings or specifications of the instrument.**

Doing so will cause damage to the instrument or overheating, resulting in serious bodily injury.



- **Do not cause a short circuit between a wire to be measured and another wire with the metal part of a jaw end of the clamp sensor.**

Doing so will cause an arc flash, resulting in serious bodily injury or damage to the instrument or other equipment.

- **Never touch the metal parts on test leads during measurement.**

Doing so will cause serious bodily injury or a short-circuit fault.

## Nickel-metal hydride batteries

### WARNING

- **Do not subject nickel-metal hydride batteries to strong impact or throw them.**



- **Do not pour water over nickel-metal hydride batteries.**

Doing so could damage the nickel-metal hydride batteries or the instrument, resulting in bodily injury.

- **Avoid using the instrument with nickel-metal hydride batteries inserted in humid or rainy locations.**

Failure to do so could damage the nickel-metal hydride batteries or the instrument, resulting in bodily injury.



- **If you find any battery abnormality (for example, leakage, odor, overheating, discoloration, and deformation) while using, charging, or storing batteries, stop using them immediately.**

Contact your authorized Hioki distributor or reseller.

### CAUTION

- **Do not mix LR6 Alkaline batteries and nickel-metal hydride batteries.**



Doing so could cause the batteries to leak, damaging the instrument.

### IMPORTANT

- Although the instrument with nickel-metal hydride batteries inserted can be used for measurement, the battery level indicator will not display a remaining battery level accurately.
- The batteries included in the shipment have an operating temperature range of  $-10^{\circ}\text{C}$  to  $45^{\circ}\text{C}$ . When using the instrument outside this temperature range, use batteries that can be used in such a low or high temperature range. (Example: lithium batteries)

# 1 Overview

## 1.1 Product Overview

The FT6041 is an earth resistance meter that measures resistance between a grounding conductor and the ground.

Earthing works on power distribution lines and electrical installations are extremely important for preventing electric shocks and fires and protecting equipment. This instrument has multiple measuring capabilities that can make accurate measurement on various objects, which is especially useful for measuring earth resistance during earthing works.

## 1.2 Features

### ● Various measurement capabilities

The instrument has various measurement capabilities that match the object to be measured.

### ● Earth-resistance clamp-using measurement (hereafter, referred to as MEC) function, which can accurately measure earth resistance in multiple earthing

Using the instrument with clamp sensors allows you to accurately measure the resistance of a specific earth electrode in multiple earthing. (when the voltage between terminals is 30 V or less)

### ● Large-diameter, low-profile clamp sensors

The current sensors designed for the instrument can be clamped around a conductor 52 mm or less in diameter and an earthing bar with a section size of 78 mm by 20 mm.

### ● Auto-ranging and auto-checking on auxiliary earth electrodes

Simply pressing the **MEASURE** button allows you to measure earth resistance and low resistance. No troublesome range switching is required. Moreover, the ground potential and resistance values of auxiliary earth electrodes can be checked automatically.

● **High acceptable earth resistances of auxiliary earth electrodes**

The instrument can tolerate a resistance value of auxiliary earth electrodes of up to 100 k $\Omega$ , enabling measurement even in adverse conditions.

● **Dust resistant and water resistant enclosure**

The instrument has an ingress protection code of IP65/IP67.

● **Drop-proof functionality (when covers with the protector)**

The instrument has a robust structure to withstand a drop to concrete from a height of 1 m.

● **Measurement cable winder**

The winders supplied with measurement cables helps you prepare for measurement and clear up the product.



## 1.3 Part Names and Functions

1

### FT6041 main unit

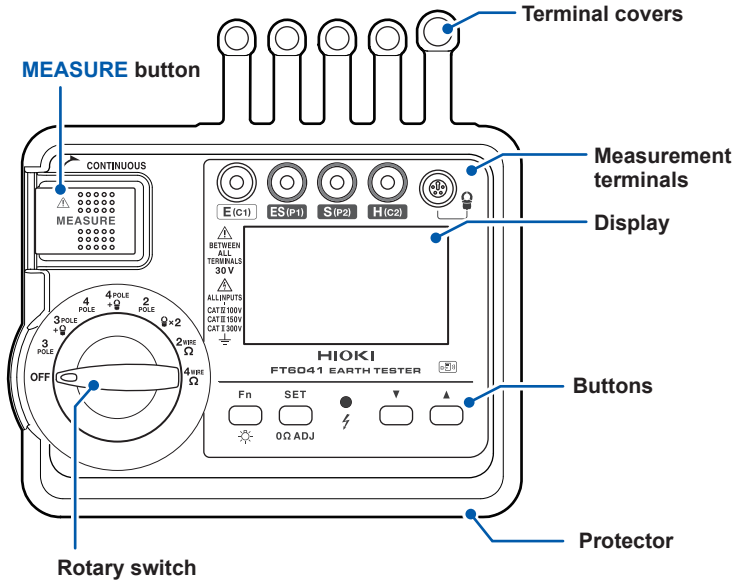
#### Front

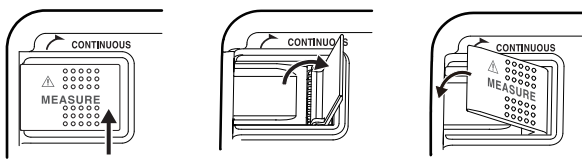

<p><b>MEASURE button</b></p>	<p>Use to start and stop an earth-resistance measurement and a low-resistance measurement.</p>  <p>Press the right side (single measurement)</p> <p>Extend (continuous measurement)</p> <p>Retract (or release)</p>
<p><b>Rotary switch</b></p>	<p>Rotate to switch the measurement function. See “3.3 Measurement Function List” (p.49)-.</p>
<p><b>Measurement terminals</b></p>	<p>Connect the black measurement cable to <b>E (C1)</b>.            Connect the blue measurement cable to <b>ES (P1)</b>.            Connect the yellow measurement cable to <b>S (P2)</b>.            Connect the red measurement cable to <b>H (C2)</b>.            Connect the CT9848 to .</p>

**Buttons**

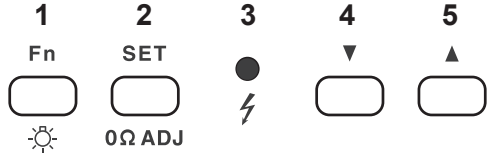





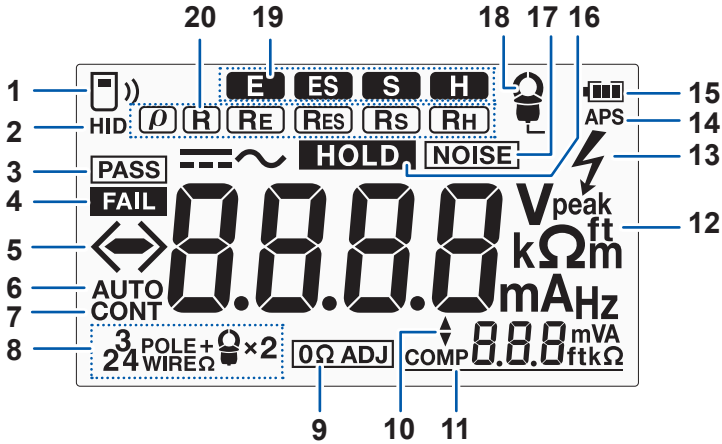

1	<b>Fn</b>	<p><b>During a ground-potential measurement</b> Press to choose from three ground-potential measuring modes: direct current, alternating current, and automatic detection.</p> <p><b>After an earth-resistance measurement</b> Press to display the resistance value of each earth electrode.</p>
	<b>Backlight (Hold for 1 s)</b>	Hold to turn the backlight on and off.
2	<b>SET</b>	Press to display the settings.
	<b>0ΩADJ (Hold for 1 s)</b>	Hold to execute a zero adjustment.
3	<b>Live-line warning indicator On</b>	Lights up during an earth-resistance measurement and a low-resistance measurement.
	<b>Live-line warning indicator Blinks</b>	<p><b>Four-pole measurement</b></p> <ul style="list-style-type: none"> <li>The voltage measurement between the <b>H (C2)</b> and <b>E (C1)</b> terminals is 85 V or more.</li> <li>The voltage measurement between the <b>S (P2)</b> and <b>ES (P1)</b> terminals is 30 V or more.</li> </ul>
		<p><b>Three-pole measurement</b></p> <ul style="list-style-type: none"> <li>The voltage measurement between the <b>S (P2)</b> and <b>E (C1)</b> terminals is 30 V or more.</li> <li>The voltage measurement between the <b>H (C2)</b> and <b>E (C1)</b> terminals is 85 V or more.</li> <li>The voltage measurement between the <b>H (C2)</b> and <b>S (P2)</b> terminals is 85 V or more.</li> </ul>
	<b>Two-pole measurement</b>	<ul style="list-style-type: none"> <li>The voltage measurement between the <b>H (C2)</b> and <b>E (C1)</b> terminals is 30 V or more.</li> </ul>
4	▼	Press to change a setting.
5	▲	The buttons are enabled when the ▲ or ▼ symbol appears on the display.

## Display



1		Indicates the existing state of the wireless communication function. (p. 87) Blinks: Connected to a mobile device On: The communications function turned on Off: The communications function turned off
2	HID	Indicates the HID function is enabled. (p. 89)
3	<b>PASS</b>	Indicates the comparator gives a pass judgment. (p. 84)
4	<b>FAIL</b>	Indicates the comparator gives a fail judgment. (p. 84)
5		The minus sign ( <b>[-]</b> ) indicates the ground potential is negative. An inequality sign ( <b>[&gt;]</b> or <b>[&lt;]</b> ) indicates that the object under measurement has a resistance beyond the measurable range (overrange).
6	AUTO	Indicates the ground-potential measurement is set to DC/AC auto-detection mode.
7	CONT	Indicates the continuous measurement function is enabled.

8	<b>4POLE</b>	Indicates the four-pole measurement is chosen.
	<b>3POLE</b>	Indicates the three-pole measurement is chosen.
	<b>2POLE</b>	Indicates the two-pole measurement is chosen.
	 x2	Indicates the two-clamp measurement is chosen.
	<b>4POLE</b> 	Indicates the four-pole MEC measurement is chosen.
	<b>3POLE</b> 	Indicates the three-pole MEC measurement is chosen.
	<b>4WIRE</b> $\Omega$	Indicated the four-terminal low-resistance measurement is chosen.
	<b>2WIRE</b> $\Omega$	Indicates the two-terminal low-resistance measurement is chosen.
9	<b>0<math>\Omega</math> ADJ</b>	Indicates the instrument has already been zero-adjusted. (p.82)
10		Indicates the upper arrow $\blacktriangle$ and lower arrow $\blacktriangledown$ buttons can be operated.
11	<b>COMP</b>	Indicates the comparator is enabled. (p.84)
12	<b>Units of measurement</b>	Indicates the measurement unit based on the measured value.
13		Indicates the instrument is making earth-resistance or low-resistance measurement by blinking the symbol. (live-line warning indicator)
14	<b>APS</b>	Indicates the power saving capability is enabled. Blinking indicates the capability will enter the instrument into auto-power saving mode in 30 s. (p.86)
15		Indicates the remaining battery level.
16	<b>HOLD</b>	Indicates the instrument freezes the measured value.
17	<b>NOISE</b>	Indicates the ground potential exceeds the acceptable range.
18		Indicates the CT9848 Clamp on Sensor needs to be connected. If the current under measurement is low, this symbol blinks. Check the clamp sensors for incorrect connection. (p.55, p.60, and p.62)
19	<b>Terminal symbols</b>	Indicates the terminals to which the measurement cables and test leads, and clamps are need to be connected. These symbols blink when each electrode has a high resistance value. (p.78)

20	$\rho$	Indicates the on-display value is the ground resistivity.
	R	Indicates the on-display value is the earth resistance.
	RE	Indicates the on-display value is the earth resistance of the earth electrode or Auxiliary Earth Electrode E.
	RES	Indicates the on-display value is the earth resistance of Auxiliary Earth Electrode ES.
	RS	Indicates the on-display value is the earth resistance of Auxiliary Earth Electrodes S.
	RH	Indicates the on-display value is the earth resistance of Auxiliary Earth Electrodes H.

**Rear**

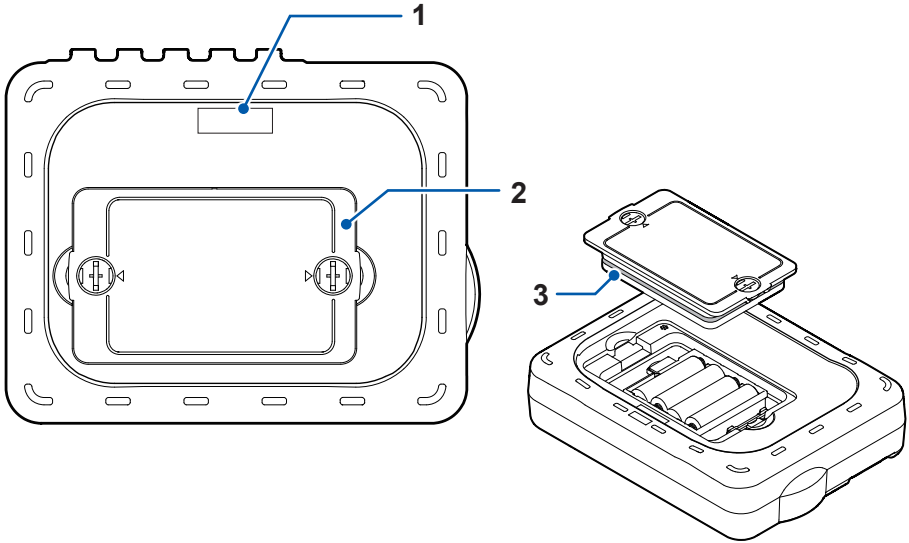

<b>1</b>	Serial number	For the latest information, check Hioki’s website. Do not remove this sticker as the number is important.
<b>2</b>	Battery compartment cover	For the compartment containing the batteries, fuse, and the Z3210.
<b>3</b>	Gasket	Prevents water from entering the instrument. If this gasket deteriorates, you should replace the entire battery compartment cover, including the gasket, with a new one. Contact your authorized Hioki distributor or reseller.

## FT9847 Signal Induction Clamp, CT9848 Clamp on Sensor

**FT9847 Signal Induction Clamp**  
(for injecting measurement signals)

**CT9848 Clamp on Sensor**  
(for detecting measurement signals)

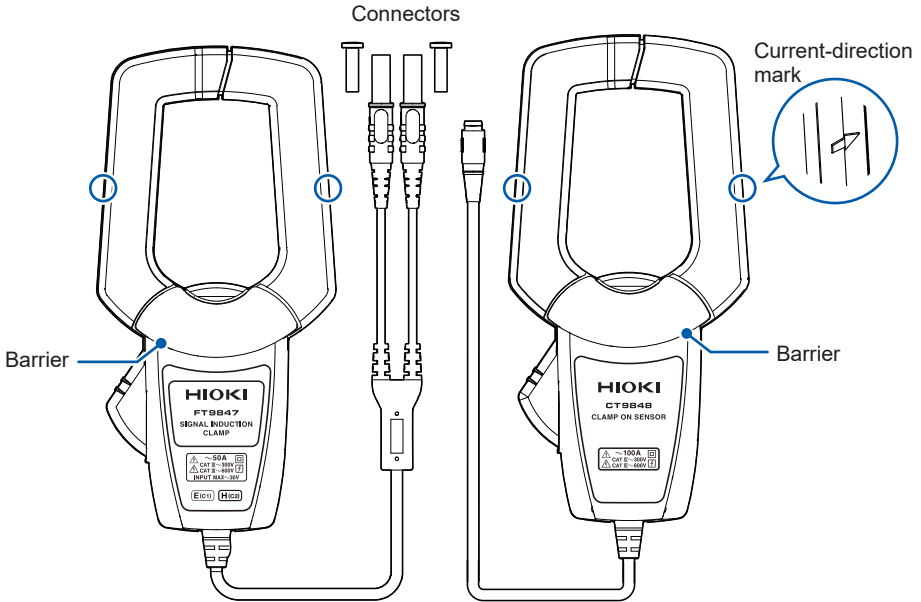

**Rear (common to two models)**

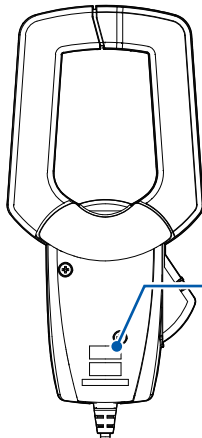

**Serial number**

The serial number consists of nine digits. The first two digits indicate the year of manufacture, while the second two digits indicate the month of manufacture. Do not remove this sticker because the number is important.



## 2.1 How to Use the Carrying Case

Store the instrument and clamp sensors in the C0208 Carrying Case, whereas the measurement cables in the C0209 Carrying Case.

### ⚠ CAUTION

- **Do not put commercially available pegs in a carrying case.**



Commercially available pegs, which have sharp tips, could damage the carrying case.

- **Do not wash carrying cases.**

Doing so could damage the carrying case.

### C0208 Carrying Case

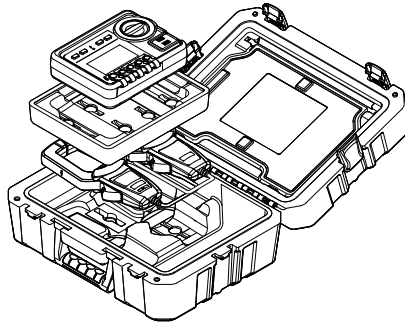

### C0209 Carrying Case



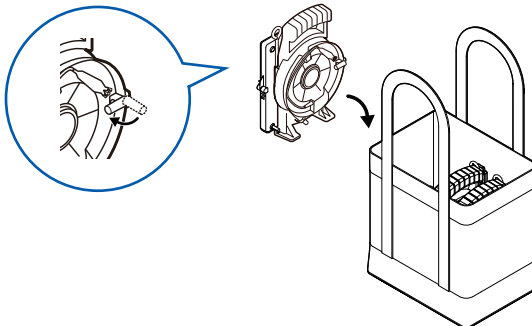

Always retract the knob of the winder before storing it in the carrying case.



## 2.2 Inserting/Replacing Batteries

Before using the instrument, insert four LR6 Alkaline batteries or fully charged nickel hydride batteries. In addition, check that the remaining battery level is sufficient before measurements. If the remaining battery level has fallen, replace the batteries. Dispose of batteries by local regulations.

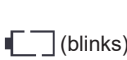
### Remaining battery level indicator

	Fully charged.
	As the batteries discharge, the inner segments disappear from the left.
	Low batteries. Replace the batteries as soon as possible.
 (blinks)	The  symbol blinks when the batteries are exhausted. The instrument cannot perform measurement. Replace the batteries with fresh ones.

### WARNING



- **Before removing the batteries, turn the rotary switch to turn the instrument off and disconnect the test leads and clamp sensors from objects under measurement.**

Failure to do so could cause the user to experience an electric shock.



- **After replacing the batteries, attach the battery compartment cover before using the instrument.**

Using the instrument with the battery compartment cover removed could result in personal injury.

- **Do not short-circuit a battery.**

- **Do not disassemble a battery.**



- **Do not throw a battery into a fire or heat it up.**

- **Do not charge an alkaline battery.**

Doing so can cause the battery to explode, resulting in bodily injury.

 **CAUTION**

- Do not mix batteries of different ages or types.
- Do not use batteries that have passed their recommended expiration date.
-  ■ Do not reverse the battery polarity.
- Do not leave exhausted batteries in the instrument.

Doing so could cause the batteries to leak, damaging the instrument.

2

### Nickel-metal hydride batteries

The battery capacity reduces due to self-discharge. Charge the batteries before first use. If the operating time is noticeably short even after charging batteries correctly, replace the batteries with fresh ones.

#### You will need:

- Phillips screwdriver (No. 2), flat-blade screwdriver, or coin
- Four LR6 Alkaline batteries or four HR6 Nickel-metal hydride batteries

**1** Disconnect the measurement cables and test leads from the instrument.

**2** Turn the rotary switch to turn the instrument off.

**3** Unlock the battery compartment cover.

Turn the two fixing knobs counterclockwise 180° with a screwdriver or a coin to align the letters **UNLOCKED** with the triangle marks (▲).

**4** Remove the battery compartment cover.

The battery compartment is sealed with the gasket. Remove one side of the battery compartment cover first, then remove the other for easy removal.

Do not remove the gasket from the battery compartment cover. (p.28)

**5** Remove all of the old batteries when replacing the batteries.

**6** Insert fresh batteries, paying attention to the polarity.

**7** Reattach the battery compartment cover.

**8 Lock the battery compartment cover.**

Turn the two fixing knobs clockwise 180° with a screwdriver or a coin to align the letters **LOCKED** with the triangle marks (▲).

The correctly attached battery compartment cover can maintain the dust resistance and water resistance capabilities.

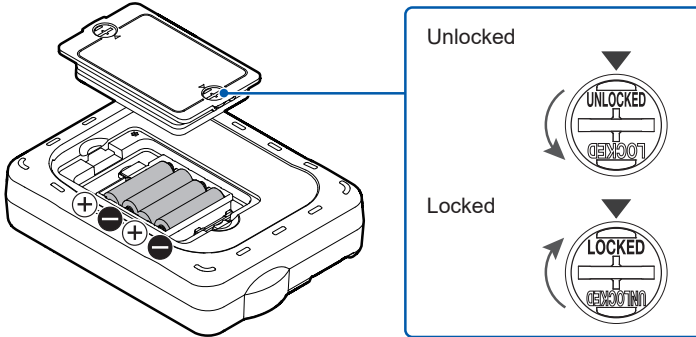

## 2.3 Connecting the Z3210 Wireless Adapter

Connecting the Z3210 Wireless Adapter (optional) to the instrument can enable the wireless communications function.

See “4.5 Wireless Communications Capability (GENNECT Cross)” (p.87).

2

### WARNING



- **Before connecting the Z3210, turn the rotary switch to turn the instrument off and disconnect the test leads and clamp sensors from objects under measurement.**

Failure to do so could cause the user to experience an electric shock.



- **After connecting the Z3210, attach the battery compartment cover before using the instrument.**

Using the instrument with the battery compartment cover removed could result in bodily injury.

### CAUTION



- **Before handling the Z3210, eliminate static electricity on your body by touching any metallic part, such as a doorknob.**

Failure to do so could cause static electricity to damage the Z3210.

**You will need:**

- Phillips screwdriver (No. 2), flat-blade screwdriver, or coin
- Z3210 Wireless Adapter (option)

**1** Disconnect the measurement cables and test leads from the instrument.

**2** Turn the rotary switch to turn the instrument off.

**3** Unlock the battery compartment cover.

Turn the two fixing knobs counterclockwise 180° with a screwdriver or a coin to align the letters **UNLOCKED** with the triangle marks (▲).

**4** Remove the battery compartment cover.

The battery compartment is sealed with the gasket. Remove one side of the battery compartment cover first, then remove the other for easy removal.

Do not remove the gasket from the battery compartment cover. (p.28)

**5** Remove the protective cap from the instrument.

**6** Exercising care to orient the Z3210 correctly, insert the Z3210 as far as it will go.

**7** Reattach the battery compartment cover.

**8** Lock the battery compartment cover.

Turn the two fixing knobs clockwise 180° with a screwdriver or a coin to align the letters **LOCKED** with the triangle marks (▲).

Correctly installing the battery compartment cover can maintain the dust resistance and water resistance capabilities.

Use a flat-head screwdriver or another suitable tool to remove the Z3210.

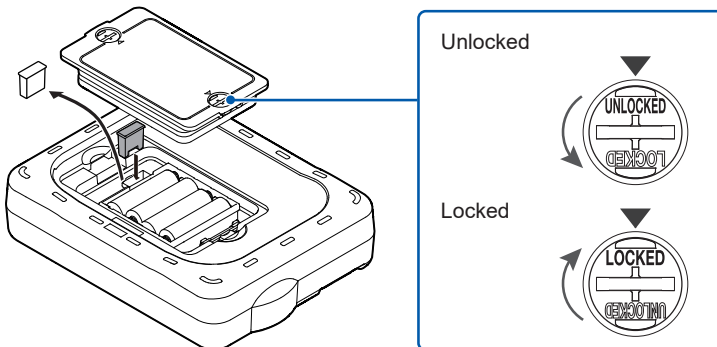

## 2.4 How to use the L9846 Earth Nets Module

The L9846 Earth Net Module can be used as an auxiliary earth electrode instead of the L9840 Auxiliary Earthing Rod for the three-pole or three-pole MEC measurements.

### WARNING



- **Wipe up water on measurement cables before connecting them to the measurement terminals.**

Failure to do so could cause the user to experience an electric shock.

### IMPORTANT

Only the 3POLE and 3POLE+MEC functions can use the L9846 Earth Net Module. Other functions cannot use it.

#### You will need:

- L9846 Earth Nets Module ×2
- L9845-31 Measurement Cable (yellow) and L9845-52 Measurement Cable (red)
- Water (Prepare 500 ml per earth net module as a guide)

- 1** Pull out the measurement cable from the winder.
- 2** Connect the connectors of the pulled-out measurement cables to the measurement terminals of the instrument.
- 3** Attach the crocodile clip to the other end of each measurement cable.
- 4** Connect the crocodile clip to the terminal of each earth net module.

- 5** Unfold and place the earth nets modules on the ground with their face down.

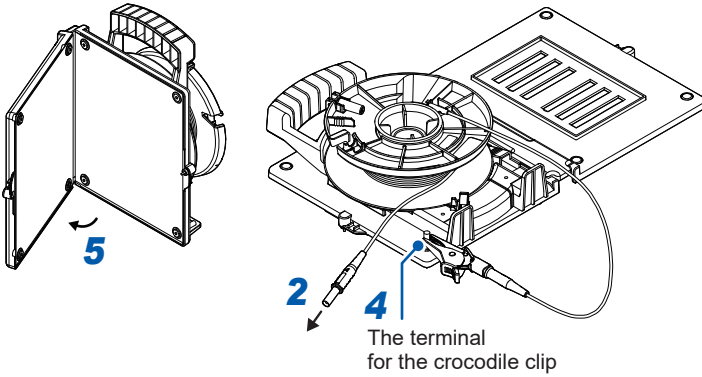

- 6** Pour water into the arrow-pointed openings as illustrated in the figure below.

- 7** Start a measurement.

After completing the measurements, dry the sets of Earth Nets Module.

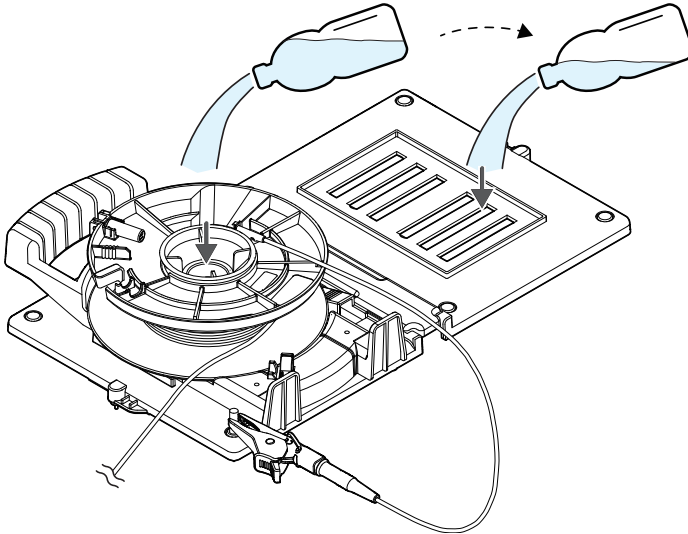

Earth Nets Module is a consumable item. You can replace damaged earth nets and sponges with new ones. Contact your authorized Hioki distributor or reseller.

## 2.5 If the Instrument Is Splashed with Water

If the instrument is splashed with water, remove the water drops by the following steps.

### DANGER



- **If the instrument is splashed with water, remove any drops of water and dry thoroughly before use.**

Using the instrument when wet will cause the user to experience an electric shock.

- 1 Hold the instrument firmly with the front facing downward, and tap it about ten times on a soft cloth until no water drops appear.**  
Lightly tap the measurement terminals, rotary switch, and buttons, including the MEASURE button, until no water drops come out.
- 2 Place a dry towel or cloth underneath and leave the instrument at room temperature for about two to three hours to dry.**  
Check that there are no water drops in the measurement terminals. Do not use the instrument if water drops remain in the measurement terminals.

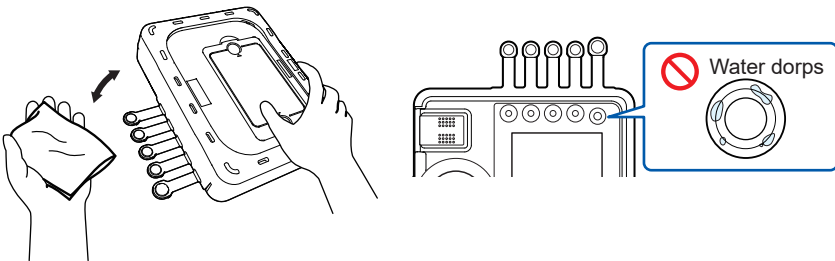

### IMPORTANT

Do not turn the rotary switch until the instrument is dry. Doing so when the instrument is wet could allow water to enter.

## In case of condensation

---

### **IMPORTANT**

If the instrument condenses, such as when it returns to room temperature from a high-temperature, high-humidity environment, remove the battery compartment cover, fuse, and batteries. Dry it at room temperature for at least 24 hours to ensure correct measurements can be performed.

**⚠ DANGER**

- **Do not connect the instrument to the primary side of a distribution panel.**

The primary side's high current capacity means that a short circuit will damage the instrument and other installations and result in serious bodily injury. If a short-circuit fault occurs on the secondary side of the distribution panel, the panel will interrupt the short-circuit current.

- **Do not allow the tip of a test lead to short-circuit two wires carrying voltage.**

Doing so will cause a short-circuit fault, resulting in serious bodily injury.



- **Do not touch any part beyond the barrier while using a clamp sensor. (p.29)**

Doing so will cause a serious bodily injury.

- **Do not measure a current that exceeds the maximum input current.**

Doing so could cause overheating, resulting in a serious bodily injury, a fire, or damage to the instrument.

The CT9848 and FT9847 have the maximum input current of 1000 A for currents between 45 Hz and 128 Hz for a 1-minute duration.

The FT9847 has the rated current of 50 A; the CT9848 has that of 100 A for currents between 45 Hz and 128 Hz.

**⚠ WARNING**

- **Check the position of the rotary switch before measurements.**



- **Remove the test leads from an object under measurement before changing the position of the rotary switch.**

Failure to do so could cause a serious bodily injury, a short-circuit fault, or damage to the instrument.

## WARNING

- **Turn all equipment off before connecting measurement cables or test leads.**

Failure to do so could cause the user to experience an electric shock or a short-circuit fault.

- **Connect the measurement cables to the input terminals securely.**

Loose terminals could result in increased contact resistance, causing the instrument to become hot or burn up or resulting in bodily injury or fire.



- **Disconnect the earth electrodes from a distribution system before measurements.**

The measurement cables have the maximum rated line-to-ground voltage of 50 V and are designed to measure earth resistance of earth electrodes disconnected from any distribution system.

- **Always dry the instrument before measurements.**

The instrument can output a voltage of approx. 30 V. Although it is dust-proof, spray-proof, and immersion-proof, failure to do so could cause the user to experience an electric shock.

## CAUTION

- **Do not connect the measurement cables if any foreign material remains inside the measurement terminals.**

Doing so could damage the instrument.



- **Do not use the FT9847 Signal Induction Clamp to measure current.**

Doing so could damage the FT9847. This clamp sensor is designed not for measuring current but is dedicated to injecting measurement signals into the FT6041.

## IMPORTANT

- Attach the terminal covers of the protector to the terminals not used for measurement. Not doing so will result in a loss of waterproof performance.
- Clamp the CT9848 Clamp on Sensor around only one conductor. Clamping around two conductors or more causes the sensor to be unable to measure currents.

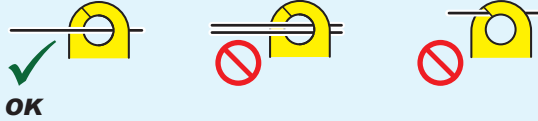

## L9787 Test Lead

### **WARNING**

- **Attach the sleeves to the optional test leads for measurements within CAT III.**



- **Stop the measurement if a sleeve comes off during it .**

Failure to do so could cause the user to experience an electric shock.  
See “Measurement categories” (p. 15).

### **CAUTION**



- **Do not touch the tips of metal pins.**

The tips of metal pins, which are sharp, could cause bodily injury.

- **When using test leads with the sleeves attached, check the sleeves for damage.**



Measurement using a test lead with a damaged sleeve attached could cause the user to experience an electric shock.

### **Removing the sleeves**

Hold the base of the sleeve and pull it off.

Store the removed sleeves for future use.

### **Attaching the sleeves**

Insert the metal pin of a test lead through the sleeve and firmly push it all the way seated in.



## 3.1 Measurement Procedure

Before using the instrument, be sure to read “Precautions for Use” (p. 17).

### Preparing for measurement

Insert the batteries in the instrument. (p.32)

As necessary, prepare other optional equipment in advance.

Perform the pre-measurement checks. (p.46)

3

### Making measurements

Choose a measurement function according to an object to be measured.

Connect the measurement cables or test leads to the measurement terminals.

Execute a zero adjustment.  
See “4.2 Zero-Adjustment Capability” (p.82).

Set a threshold value.  
See “4.3 Setting Up the Comparator and Defining the Measurement Conditions”  
(p.84).

Connect the measurement cables or test leads to an object to be measured.

Start a measurement.

### Finishing the measurement

Turn the instrument off and remove the measurement cables or test leads from the object under measurement.

## 3.2 Inspecting the Instrument Before Measurements

### DANGER

- **Inspect the instrument and verify proper operation before use.**

Use of the instrument while it is malfunctioning will result in serious bodily injury.



If you find any damage, contact your authorized Hioki distributor or reseller.

- **Check the cables to see if the inner white insulation is not exposed.**

Using the instrument with a cable with its inner color exposed will cause the user to experience an electric shock.

- The battery level is sufficient.**

Turn the instrument on to check the battery level indicator on the upper right corner of the display.

If the  symbol is blinking, the battery level is low.

Replace the batteries with fresh ones.

See “2.2 Inserting/Replacing Batteries” (p.32).

- The display has no missing segment.**

Have all segments displayed to check for missing ones. If the display has a missing segment, request repair.

See “4.7 Displaying All Segments on the Display” (p.91) and “1.3 Part Names and Functions” (p.23).

- The instrument does not have any damage or cracks.**

Make visual check of the instrument.

If damage is found, request repair.

- The measurement terminals do not have any foreign matter, such as sand, in them.**

Remove all foreign matter if any.

If it cannot be removed, request repair.

- The measurement cables or test leads have no damaged insulation or no exposed inner white parts or metal.**

If damage is found, replace them without use.

- Use the following method to check for a break in the measurement cables and test leads.**

- 1** Turn the rotary switch and check if the **[4POLE]**, **[3POLE]** or **[2POLE]** symbol is displayed on the display.

Measurement method	Rotary switch	Display
Four-pole measurement	<b>4POLE</b>	<b>[4POLE]</b>
Three-pole measurement	<b>3POLE</b>	<b>[3POLE]</b>
Two-pole measurement	<b>2POLE</b>	<b>[2POLE]</b>

- 2** Connect the measurement cables or test leads to the instrument and short-circuit their tips.

- 3** Press the **MEASURE** button to check the instrument indicates approx. **0Ω**.

**If the instrument indicates any value other than approx. 0Ω**

- A measurement cable or test lead has not been fully inserted. Fully insert it.
- A measurement cable or a test lead may have a break. Replace it with a Hioki-specified one. The instrument may be damaged if the problem remains even after the measurement cable or test lead is replaced. Request for repair.

- Check for a blown fuse. (only for low-resistance measurement)**

- 1** Remove the fuse from the instrument

- 2** Reattach the battery compartment cover.

- 3** Use the simplified earth-resistance measuring function of the instrument to measure the fuse resistance.

Replace the fuse with a new one if it has a resistance of more than 3Ω.

- **Set the instrument to the 2CLAMP function to check the FT9847 Signal Induction Clamp and the CT9848 Clamp on Sensor for proper operation.**



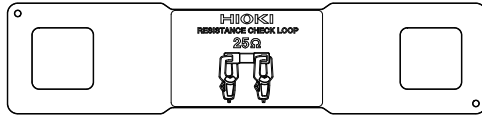

Check that no foreign matter is caught between the ends and that the jaws can open and close smoothly.

Clamp the FT9847 Signal Induction Clamp and the CT9848 Clamp on Sensor around the operation-check resistor to see if the instrument displays the acceptable value.

See “3.9 Measuring Earth Resistance (Two-Clamp Measurement)” (p.62).



### 3.3 Measurement Function List

Function		Physical quantity to be measured	Measurement method	Description
<b>3</b> POLE	<b>3POLE</b>	Earth resistance	Three-pole measurement	Used to measure earth resistance precisely. “3.5 Measuring Earth Resistance (Three-Pole Measurement)” (p.51)
<b>3</b> POLE + 	<b>3POLE+ CLAMP</b>	Earth resistance (multiple)	Three-pole measurement (MEC)	Used to measure a specific earth resistance precisely in multiple earthing. “3.6 Measuring Earth Resistance (Three-Pole MEC Measurement)” (p.55)
<b>4</b> POLE	<b>4POLE</b>	Ground resistivity	Four-pole measurement	Used to measure ground resistivity required to choose an appropriate earthing work method. “3.7 Measuring Ground resistivity (Four-Pole Measurement)” (p.57)
<b>4</b> POLE + 	<b>4POLE+ CLAMP</b>	Earth resistance (multiple)	Four-pole measurement (MEC)	Used to measure a specific earth resistance more precisely in multiple earthing. “3.1 Measurement Procedure” (p.45)
 × 2	<b>2CLAMP</b>	Earth resistance (multiple)	Two-clamp measurement	Used to measure an earth resistance in multiple earthing. “3.9 Measuring Earth Resistance (Two-Clamp Measurement)” (p.62)
<b>2</b> POLE	<b>2POLE</b>	Earth resistance	Two-pole measurement	Used to measure earth resistance in a quick manner. “3.10 Measuring Earth Resistance Using a Simple Method (Two-Pole Measurement)” (p.64)
<b>2</b> WIRE 	<b>2WIRE</b>	Low resistance	Two-terminal measurement	Used to measure interconnection resistance between the earth electrode and an installation. “3.11 Measuring Low Resistance (Two-Terminal Measurement)” (p.68)
<b>4</b> WIRE 	<b>4WIRE</b>	Low resistance	Four-terminal measurement	This method is used to measure interconnection resistance between the earth electrode and an installation precisely. “3.12 Measuring Low Resistance (Four-Terminal Measurement)” (p.71)

Several earth-resistance measurement methods are available. The three-pole measurement is basically used to measure earth resistance.

The simplified earth-resistance measurement method (two-pole measurement) is used if the three-pole measurement is unavailable.

To measure earth resistance employing the three-pole measurement, two auxiliary earthing rods need to be driven into the ground as shown in the figure in “Making measurements” (p.53).

## 3.4 Defining the Measurement Conditions

### Setting the voltage

For the four-pole and three-pole measurement, usually set the output voltage to 30 V. If your body extremely wet, set it to 20 V.

For the two-pole measurement, usually set the output voltage to 8 V. If measured values fluctuate due to noise, change it to 20 V. Check the sensitivity current of the earth leakage breaker before changing the output voltage because the breaker could trip.

### Setting the measurement frequency

Set the frequency to 128 Hz. If measured values fluctuate due to noise, change it to 94 Hz, 105 Hz, or 111 Hz.

When you want to make earth-resistance measurement under conditions closer to the commercial-power frequency, set the frequency to 55 Hz.

### Setting the distance

Set the distance between the auxiliary earth electrodes used for the four-pole measurement.

## 3.5 Measuring Earth Resistance (Three-Pole Measurement)

The three-pole measurement is used to measure earth resistance precisely. See “7.3 Tips on the Three-pole Measurement” (p. 130).

### Measurement on a large-scale earth electrode

For measurement on large-scale earth electrodes, such as mesh earth electrodes, ring earth electrodes, and earth electrodes provided by a large building structure, earth resistance cannot be accurately measured because Electrodes H (C) and S (P) come inside the earth resistance area of Electrode E. If long cables are used to avoid Electrodes H (C) and S (P) getting inside the earth resistance area, measurement becomes significantly susceptible to noise, causing accurate measurement to be impossible.

In general, measurements on a large-scale earth electrode requires a large measurement current of about 20 A. Use a measuring instrument designed for measurements on large-scale earth electrodes (no measuring instrument available for this purpose from Hioki).

## IMPORTANT

### Making measurements on concrete

- Auxiliary earth electrodes can be laid on concrete because concrete is a conductive material.
- Lay the L9846 Earth Nets Module or the auxiliary earthing rod on concrete and pour water over it, or cover a wet cloth over the auxiliary earthing rod to use it as an auxiliary earth electrode.
- If pouring water over the auxiliary earthing rod laid cannot reduce the earth resistance of the auxiliary earth electrode, place the 9050 Earth Nets on concrete, lay the auxiliary earthing rod on the earth nets, and pour water over them.
- Allow some time for the water to well soak into the concrete before measurements.
- A conductive planar object, such as a metal plate and aluminum foil, can be used instead of the Earth Nets.
- In general, the auxiliary earth electrodes cannot be used on asphalt, which is an insulating material. However, measurement may be possible on porous asphalt, which has water penetrability.

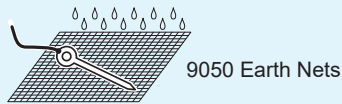

## Making measurements

### You will need:

L9841 Measurement Cable (crocodile clip, black), L9845-31 Measurement Cable (yellow), L9845-52 Measurement Cable (red), L9840 Auxiliary Earthing Rod  $\times 2$ , tape measure

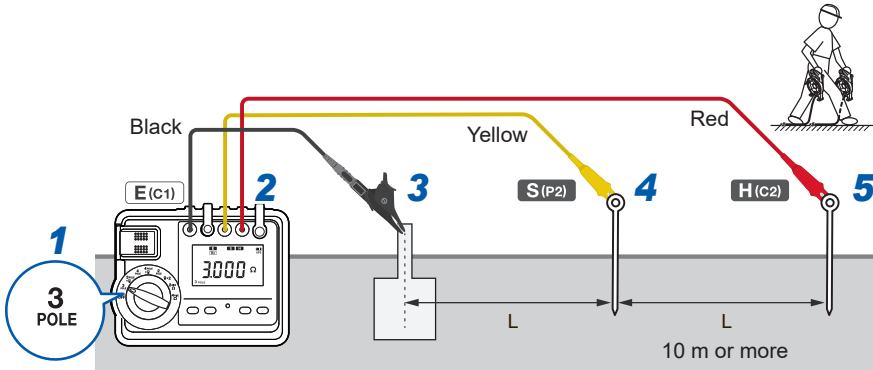

Disconnecting the earth electrode from the installation allows the instrument to measure earth-resistance values correctly. Disconnect the earth electrode from the installation before starting a measurement. If the earth electrode cannot be separated from the equipment, make measurements using the three-pole MEC measurement.

Always execute a zero adjustment before measurements. (p. 82)

- 1** Set the rotary switch to the **3POLE** position.
- 2** Connect the measurement cables to the measurement terminals of the instrument.

E (C1) terminal	L9841 Measurement Cable	Black
S (P2) terminal	L9845-31 Measurement Cable	Yellow
H (C2) terminal	L9845-52 Measurement Cable	Red

- 3** Connect the measurement cable (black) to the earth electrode.
- 4** Drive an auxiliary earthing rod into the ground 10 m or more away from the earth electrode and connect the measurement cable (yellow).
- 5** Drive another auxiliary earthing rod into the ground 10 m or more away from Auxiliary Earth Electrodes S and connect the measurement cable (red).

**6 Press the MEASURE button.**

The instrument makes measurements automatically in the following order:  
Ground-potential check → Auxiliary-earth-resistance check → Earth-resistance measurement

Upon the completing of the measurement, the instrument displays the measured value and the **HOLD** symbol.

**7 Check the measured values.**

The on-display parameters can be changed after the measurements.

Press the **Fn** button to switch the parameters.

- Drive the auxiliary earthing rods into a moist layer in the ground. The auxiliary earthing rods do not need to be driven unnecessarily deep into the ground because the instrument can accept a large resistance of the auxiliary earth electrodes.
- Position the yellow and red measurement cables about 100 mm away from each other to prevent them from overlapping.

## 3.6 Measuring Earth Resistance (Three-Pole MEC Measurement)

Three-pole MEC measurement is used to measure a specific earth resistance precisely in multiple earthing.

See “7.3 Tips on the Three-pole Measurement” (p. 130).

### Making measurements

#### You will need:

L9841 Measurement Cable (crocodile clip, black), L9845-31 Measurement Cable (yellow), L9845-52 Measurement Cable (red), L9840 Auxiliary Earthing Rod  $\times 3$ , tape measure

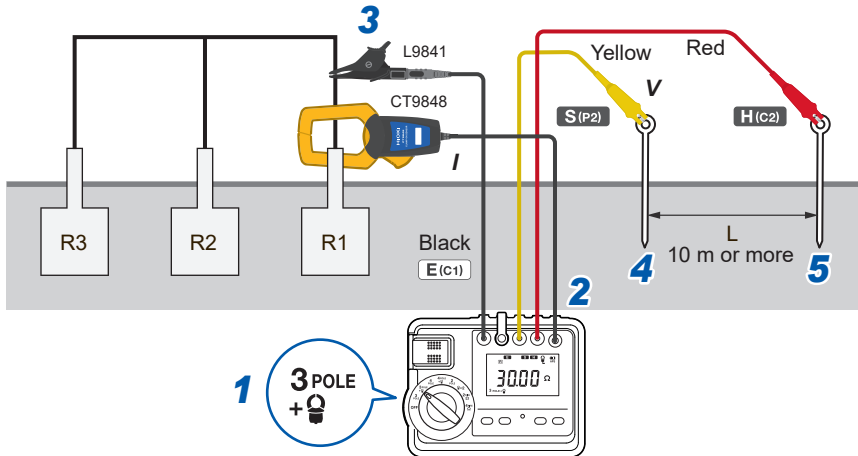

Always execute a zero adjustment before measurements. (p.82)

- 1** Set the rotary switch to the **3POLE+CLAMP** position.
- 2** Connect the measurement cables to the measurement terminals of the instrument.

E (C1) terminal	L9841 Measurement Cable	Black
S (P2) terminal	L9845-31 Measurement Cable	Yellow
H (C2) terminal	L9845-52 Measurement Cable	Red

- 3** Connect the measurement cable (black) to the earth electrode.
- 4** Clamp the **CT9848 Clamp on Sensor** around the earth electrode so that the earth electrode passes through the center of the clamp aperture.  
Clamp the sensor around the grounding conductor between the measurement cable (black) and the earth electrode so that the current direction mark of the sensor points the measurement cable (black).
- 5** Drive an auxiliary earthing rod into the ground 10 m or more away from the earth electrode and connect the measurement cable (yellow).
- 6** Drive another auxiliary earthing rod into the ground 10 m or more away from Auxiliary Earth Electrodes S and connect the measurement cable (red).
- 7** Press the **MEASURE** button.

The instrument makes measurements automatically in the following order:

Ground-potential check → Auxiliary-earth-resistance check → Earth-resistance measurement

Upon the completing of the measurement, the instrument displays the measured value and the **HOLD** symbol.

- 8** Check the measured values.

The on-display parameters can be changed after the measurements.

Press the **Fn** button to switch the parameters.

- The instrument can measure earth-resistance values correctly even if the earth electrodes are not disconnected from the installation.
- Do not measure earth resistance when the installation is in operation.

#### **IMPORTANT**

Pay attention to the positions of the measurement cable (black) and the CT9848. Incorrect connection causes measurements to be impossible.

## 3.7 Measuring Ground resistivity (Four-Pole Measurement)

Used to measure ground resistivity required to choose an appropriate earthing work method.

Assuming that the inter-pole distances ( $L$ ) are equal, calculate the ground resistivity ( $\rho$ ) using the following formula:

$$\rho = 2\pi LR$$

3

### Setting the distance

- 1 Set the rotary switch to the **4POLE** position.
- 2 Press the **SET** button (**0QADJ** button) to display the distance setting (for 4POLE only)

Every time the **SET** button (**0QADJ** button) is pressed, the on-display contents change.

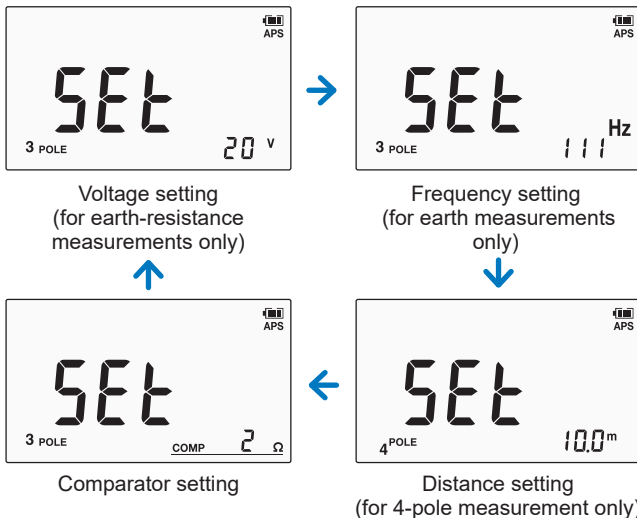

- 3 Press the **▲** button or **▼** button to change the settings.

1.0 m to 50.0 m (settable in increments of 0.1 m)

3 ft. to 160 ft. (settable in increments of 1 ft.)

To change the unit to foot (ft.), see "Changing the unit of length" (p. 58)

## Changing the unit of length

The unit of length can be switched between the two kinds of units: meter (m) and foot (ft).

- 1** While holding the **SET** button, turn the instrument on.  
The serial number is displayed.
- 2** Hold the **SET** button until the **[Unit]** message appears.
- 3** Use the **▲** and **▼** buttons to switch between the two kinds of units: meter (m) and foot (ft).
- 4** Press the **SET** button to confirm.  
The screen changes to the measurement screen.

## Making measurements

You will need:

L9841 Measurement Cable (crocodile clip, black), L9845-33 Measurement Cable (blue), L9845-31 Measurement Cable (yellow), L9845-52 Measurement Cable (red), L9840 Auxiliary Earthing Rod ×4, tape measure

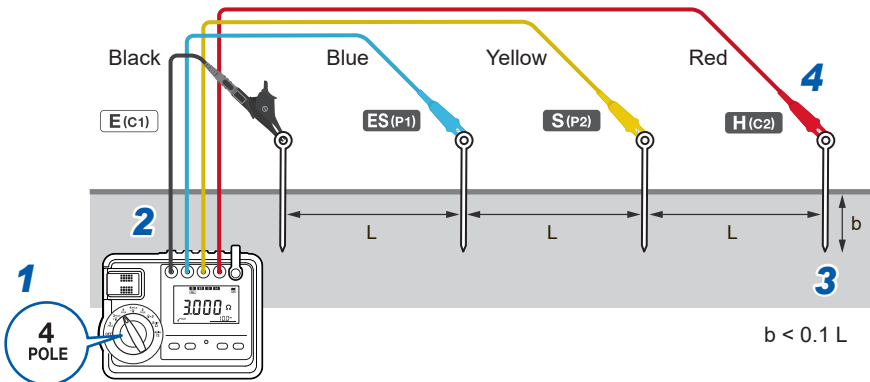

Always execute a zero adjustment before measurements. (p.82)

- 1** Set the rotary switch to the **4POLE** position.
- 2** Connect the measurement cables to the measurement terminals of the instrument.

E (C1) terminal	L9841 Measurement Cable	Black
ES (P1) terminal	L9845-33 Measurement Cable	Blue
S (P2) terminal	L9845-31 Measurement Cable	Yellow
H (C2) terminal	L9845-52 Measurement Cable	Red

- 3** Place the four auxiliary earthing rods at the set regular intervals and drive them into the ground.

Drive each auxiliary earthing rod to a depth (b) of less than one tenth of the distance set.

- 4** Connect the measurement cables to the measurement terminals of the instrument and objects to be measured.

- 5** Press the **MEASURE** button.

The instrument makes measurements automatically in the following order:  
Ground-potential check → Auxiliary-earth-resistance check → Earth-resistance measurement

The instrument displays the measured value and the **HOLD** symbol.

- 6** Check the measured values.

The on-display parameters can be changed after measurements.

Press the **Fn** button to switch the parameters.

### 3.8 Measuring Earth Resistance (Four-Pole MEC Measurement)

Used to measure a specific earth resistance more precisely in multiple earthing.

#### Making measurements

You will need:

L9841 Measurement Cable (crocodile clip, black), L9845-33 Measurement Cable (blue), L9845-31 Measurement Cable (yellow), L9845-52 Measurement Cable (red), CT9848 Clamp on Sensor (for detecting signals), L9840 Auxiliary Earthing Rod  $\times 2$ , tape measure

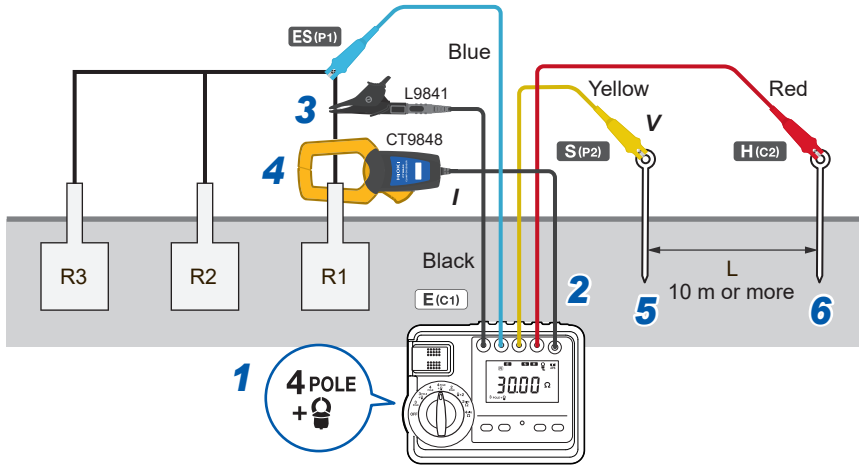

Always execute a zero adjustment before measurements. (p.82)

- 1** Set the rotary switch to the **4POLE+CLAMP** position.
- 2** Connect the measurement cables and the clamp sensor to the measurement terminals of the instrument.

E (C1) terminal	L9841 Measurement Cable	Black
ES (P1) terminal	L9845-33 Measurement Cable	Blue
S (P2) terminal	L9845-31 Measurement Cable	Yellow
H (C2) terminal	L9845-52 Measurement Cable	Red
Clamp terminal	CT9848 Clamp on Sensor	Black

- 3** Connect the **L9841 Measurement Cable** to the earth electrode.
- 4** Clamp the **CT9848 Clamp on Sensor** around the earth electrode so that the earth electrode passes through the center of the clamp aperture.  
Clamp the sensor around the grounding conductor between the measurement cable (black) and the earth electrode so that the current direction mark of the sensor points the measurement cable (black).
- 5** Drive an auxiliary earthing rod into the ground 10 m or more away from the earth electrode and connect the measurement cable (yellow).
- 6** Drive another auxiliary earthing rod into the ground 10 m or more away from Auxiliary Earth Electrodes S and connect the measurement cable (red).

- 7** Press the **MEASURE** button.

The instrument makes measurements automatically in the following order:  
Ground-potential check → Auxiliary-earth-resistance check → Earth-resistance measurement

The instrument displays the measured value and the **HOLD** symbol.

- 8** Check the measured values.

The on-display parameters can be changed after the measurements.

Press the **Fn** button to switch the parameters.

- The instrument can measure earth-resistance values correctly even if the earth electrodes are not disconnected from the installation.
- Do not measure earth resistance when the installation is in operation.

### 3.9 Measuring Earth Resistance (Two-Clamp Measurement)

This measurement method is used to measure earth resistance in multiple earthing points.

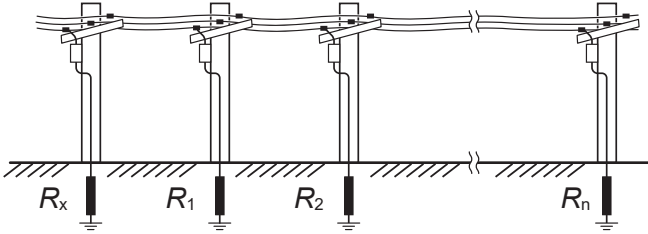

#### Making measurements

You will need:

FT9847 Signal Induction Clamp (for injecting measurement signals), CT9848 Clamp on Sensor (for detecting measurement signals)

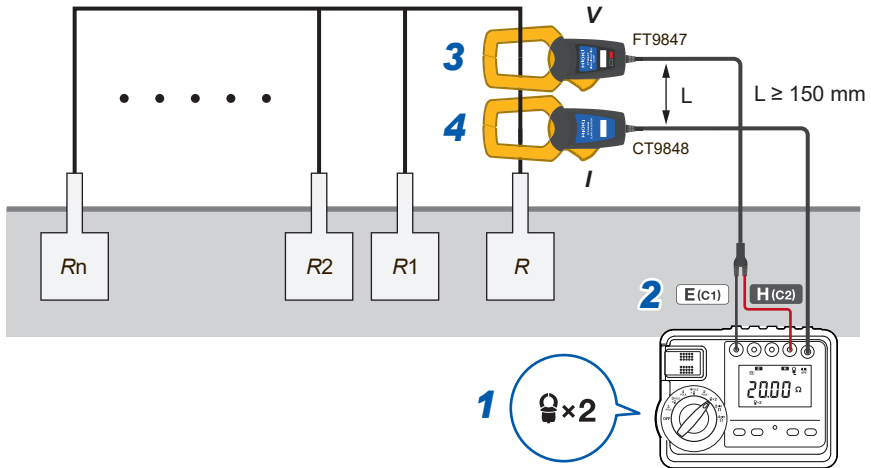

- 1** Set the rotary switch to the **2CLAMP** position.
- 2** Connect the measurement cables and the clamp sensors to the measurement terminals of the instrument.

E (C1) terminal	FT9847 Signal Induction Clamp	Black
H (C2) terminal	FT9847 Signal Induction Clamp	Red
Clamp terminal	CT9848 Clamp on Sensor	Black

- 3** Clamp the **FT9847 Signal Induction Clamp** around an earth electrode so that the electrode passes through the aperture center of the sensor.
- 4** Clamp the **CT9848 Clamp on Sensor** around the same earth electrode so that the earth electrode passes through the center of the clamp aperture. Arrange the CT9845 so that the arrows on the FT9847 and CT9845 point in the same direction.  
Place the FT9847 and CT9848 150 mm or more apart to avoid measurement errors.
- 5** Press the **MEASURE** button.

The instrument makes measurements, displaying the measured value and the **HOLD** symbol.

## 3.10 Measuring Earth Resistance Using a Simple Method (Two-Pole Measurement)

This measurement method is used to measure earth resistance in a quick manner.

### DANGER

- **Before connecting the instrument, use a device, such as a voltage detector, to make sure that the wire to be connected is the neutral side.**

This measurement method uses the neutral side (the earth side) of commercial power. An incorrect connection will cause the user to experience an electric shock.



- **Connect the instrument to either of the following:**

- **The neutral side of an outlet with a line-to-ground voltage of 300 V or less**
- **The wire on the neutral side of the breaker secondary side with a line-to-ground voltage of 150 V or less.**

Connection to any other points will cause the user to experience an electric shock.

---

 **WARNING**

- **Do not use the instrument for measuring the voltage of commercial power.**

Doing so could cause the user to experience an electric shock.

- **Do not use the two-pole measurement for measurements on a location in which a earth leakage breaker or an earth leakage relay with a current sensitivity of less than 10 mA is installed.**



The instrument with the two-pole measurement setting and an output voltage set to 8 V limits the measurement current to 4 mA or less. However, if it is connected to the earth side of a commercial power supply, high-sensitivity earth-leakage circuit breakers and earth-leakage relays with a sensitivity current of less than 10 mA could trip, potentially causing damage to the facility and bodily injury. Ordinary earth-leakage breakers, excluding those, will not trip.

- **Disconnect the test leads from commercial power as soon as the live-line warning indicator (⚡) starts to flash on and off.**



If the earth voltage is high, a large voltage is applied to the neutral side, possibly causing the user to experience an electric shock.

**IMPORTANT**

The simplified measurement function of the instrument can be used to measure earth resistance with small inductance component. Thus, a resistance with which an inductance component of 3 mH or more is connected in series may not be accurately measured.

## Making measurements

### You will need:

L9787 Test Lead (optional)

Example: Measuring the earth resistance at a breaker or an outlet using the neutral side

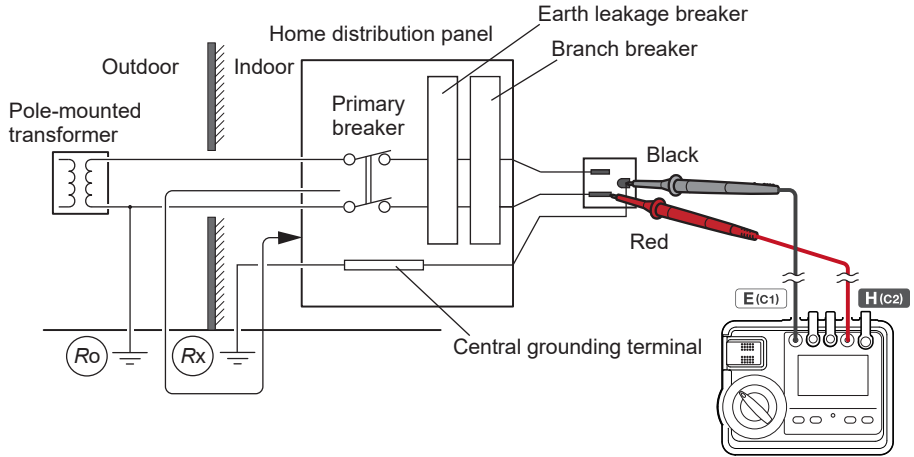

Always execute a zero adjustment before measurements. (p.82)

- 1 Use an instrument, such as a voltage detector, to ensure that the neutral (N) side of commercial power has no voltage.**
- 2 Connect the L9787 Test Lead (black) with the earth electrode of an object to be measurement.**
- 3 Connect the L9787 Test Lead (red) with the neutral (N) side of commercial power.**  
The ground potential is displayed.
- 4 Press the MEASURE button.**  
The instrument makes measurements automatically in the following order:  
Ground-potential check → Earth-resistance measurement  
The measured value and the **HOLD** symbol are displayed.
- 5 Check the measured values.**  
The on-display parameters can be changed after measurements.  
Press the **Fn** button to switch the parameters.

#### **IMPORTANT**

Set the output voltage to 20 V if measured values fluctuate due to noise. However, doing so could cause the earth leakage breaker to trip; thus, check the sensitivity current of the earth leakage breaker before changing the output voltage setting.

## 3.11 Measuring Low Resistance (Two-Terminal Measurement)

This measurement method is used to measure interconnection resistance between the earth electrode and an installation. For more precise measurement, use the Four-terminal measurement.

### Making measurements

---

**You will need:**

L9787 Test Lead (optional)

Example: Checking the continuity of the earth wire.

### DANGER

- **Do not make low-resistance measurements while the object to be measured is energized.**



Doing so will damage the instrument, resulting in bodily injury. Shut off the power to the object to be measured before measurements.

---

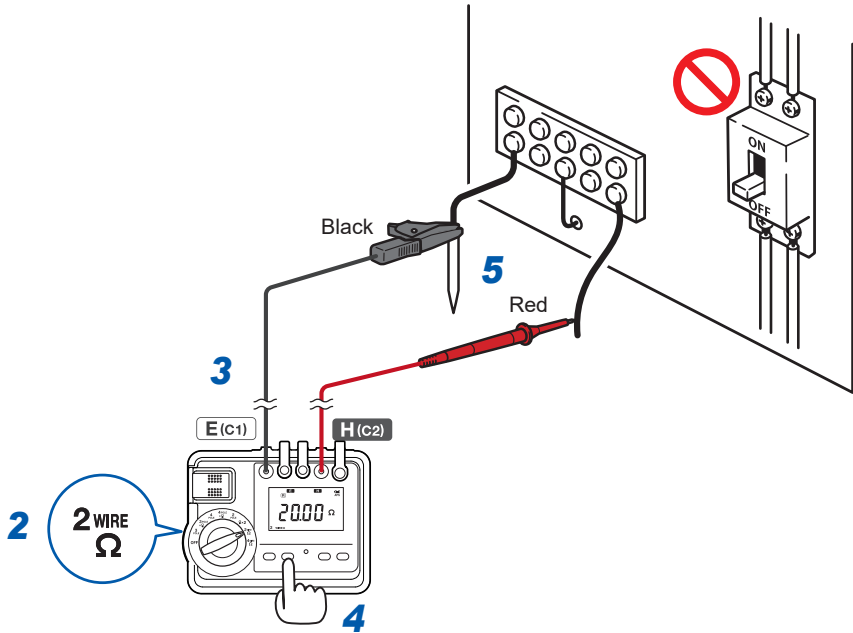

- 1** Use an instrument, such as a voltage detector, to ensure that the object to be measured has no voltage.
- 2** Set the rotary switch to the **2WIRE**  $\Omega$  position.
- 3** Connect the measurement cables to the measurement terminals of the instrument.

E (C1) terminal	L9787 Test Lead	Black
H (C2) terminal	L9787 Test Lead	Red

- 4** Execute a zero adjustment.  
See “4.2 Zero-Adjustment Capability” (p.82).
- 5** Connect the L9787 Test Lead to an object to be measured.
- 6** Press the **MEASURE** button.  
Extend the **MEASURE** button to make measurements continuously.
- 7** Check the measured value.

**IMPORTANT**

- When some circuits in operation have been connected in parallel to a circuit to be measured, the impedance and transient current of such circuits may cause measurement errors.
- If a capacitance component is connected in parallel with an object under measurement, correct measurement values may not be obtained.
- The auto-ranging capability may not work stably depending on the object under measurement, such as motors, transformers, and coils.

## 3.12 Measuring Low Resistance (Four-Terminal Measurement)

This method is used to measure interconnection resistance between the earth electrode and an installation precisely.

### Making measurements

#### You will need:

9772 Pin Type Lead or 9467 Large Clip Type Lead (optional)

Example: Checking the continuity of the earth wire

### DANGER

- **Do not make low-resistance measurements while an object to be measured is energized.**



Doing so will damage the instrument, resulting in bodily injury. Shut off the power to the object to be measured before measurements.

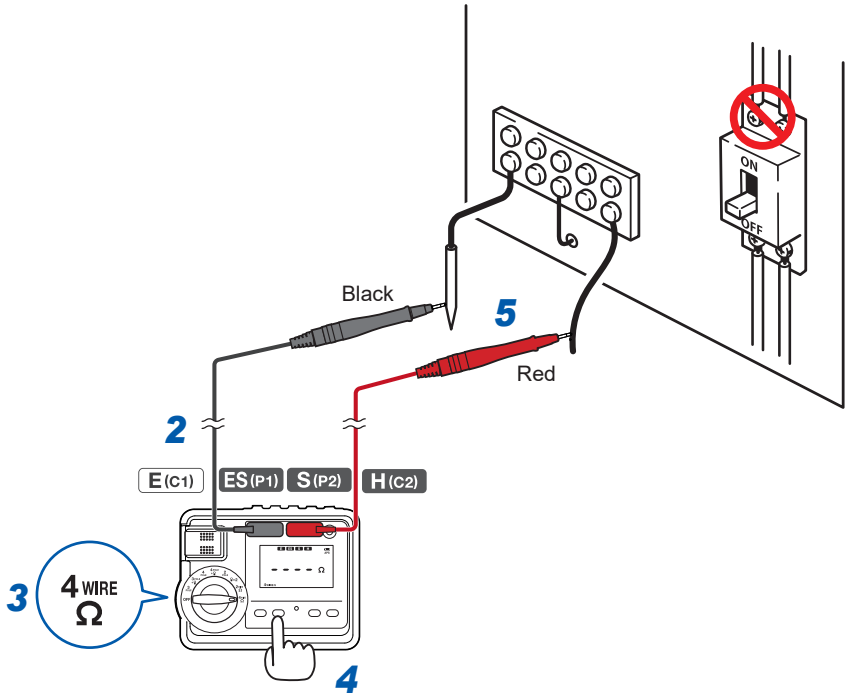

- 1** Use an instrument, such as a voltage detector, to ensure that the object to be measured has no voltage.
- 2** Connect the measurement cables to the measurement terminals of the instrument.

E (C1) terminal	9772 Pin Type Lead or 9467 Large Clip Type Lead (optional)	Black
S (P2) terminal	9772 Pin Type Lead or 9467 Large Clip Type Lead (optional)	Red

- 3** Set the rotary switch to the **4WIRE** position.
- 4** Perform a zero adjustment.  
See “4.2 Zero-Adjustment Capability” (p. 82).
- 5** Connect the Test Lead to an object to be measured.
- 6** Press the **MEASURE** button.  
Extend the **MEASURE** button to make measurements continuously.
- 7** Check the measured value.

**IMPORTANT**

- If a circuit in operation is connected in parallel to the circuit under measurement, the impedance and transient current of such circuit may cause measurement errors.
- If a capacitance component is connected in parallel with an object under measurement, correct measurement values may not be obtained.
- The auto-ranging capability may not work stably depending on the object under measurement, such as motors, transformers, and coils.

### 3.13 When the [NOISE] Symbol Appears

- When the instrument displays the **[NOISE]** symbol, turns the live-line warning indicator (⚡) on and off, and turns the backlight on  
The instrument cannot make earth-resistance or low-resistance measurements.
- When the instrument displays the **[NOISE]** symbol and the ground-potential peak value  
The instrument may not make earth-resistance or low-resistance measurements correctly due to noise.

#### Conditions for displaying the NOISE symbol

- (1) During earth-resistance measurements, the ground potential is high.  
(over 30 V rms or 42.4 V peak)
- (2) During low-resistance measurements, the inter-terminal voltage is high.  
(over 30 V AC, over 5 V peak, or under -5 V)

#### If the NOISE symbol appears

Since leak currents are flowing into the earth electrodes, disconnect any electric installations from the earth electrodes and then press the **MEASURE** button again.

## 3.14 Measuring the Ground Potential

- The instrument automatically measures the ground potential during earth-resistance measurements. If the ground potential reaches an unacceptable level, it does not make earth-resistance measurements, turning the live-line warning indicator on.
- The instrument automatically detects whether the ground potential is AC or DC (⤿ / ▬▬▬).

When you want to switch manually between the ground-potential measuring modes, AC and DC, press the **Fn** button while the present ground potential has been displayed.

- To check the ground potential after an earth resistance measurement

After an earth-resistance measurement, press the **Fn** button while the **HOLD** symbol is displayed to display the ground potential. In addition, adjust the rotary switch to another function then set its original position to unfreeze the display, allowing the present ground potential to appear.

## 3.15 If a Terminal Symbol Blinks

The instrument automatically checks to see if each earth resistance is within the acceptable range by measuring the earth-resistance values of the auxiliary earthing rods before measuring the resistance of earth electrodes. Additionally, it detects whether the measurement terminals are open during the four-terminal low-resistance measurement.

If the earth resistance of an auxiliary earth electrode exceeds the acceptable range, the instrument blinks the terminal symbol (**E**, **ES**, **S**, or **H**; p.25) below the relevant measurement terminal, not measuring the earth resistance of earth electrodes. For low-resistance measurement, the instrument blinks the two terminal symbols **E** and **H**, or **ES** and **S**, not measuring low resistance.

### Solutions

#### Earth-resistance measurement

Follow the procedures below for the auxiliary earthing rod connected with the measurement terminal of which the terminal symbol (**E**, **ES**, **S**, or **H**) blinks.

- Pour water on it.
- Drive it deeper in the ground.
- Drive it into another location.
- If the clip connected point is dirty, wipe the auxiliary earthing rod with a soft cloth to clean.

In addition, pressing the **Fn** button allows the instrument to display the earth-resistance value and ground potential of each earth electrode.

**RE**

Indicates the on-display value is the earth resistance of Earth Electrode E.

**RES**

Indicates the on-display value is the earth resistance of Auxiliary Earth Electrode ES.

**RS**

Indicates the on-display value is the earth resistance of Auxiliary Earth Electrodes S.

**RH**

Indicates the on-display value is the earth resistance of Auxiliary Earth Electrodes H.

~ / 

Indicates the on-display value is the ground potential

- Measured values of the auxiliary earth electrodes are for automatic check to confirm whether the earth electrode can be measured. It has no resolution as much as that of measured values of the earth electrode.

For the resolution of earth resistance of auxiliary earth electrodes, see “Specifications” (p.93).

- For example, when the resistance of Auxiliary Earth Electrodes H ( $R_H$ ) exceeds  $5\text{k}\Omega$ , the instrument switches to the  $300\Omega$  display range, not displaying the digit at the second decimal place even if the resistance of the earth electrode is  $30\Omega$  or less. The following table shows some examples.

When you need values shown to two decimals, pour some water over the auxiliary earthing rod (H) to reduce the earth-resistance value to  $5\text{k}\Omega$  or less.

Resistance of Auxiliary Earth Electrodes H ( $R_H$ )	Example of indicated value (1) When the measured value is $9.52\Omega$	Example of indicated value (2) When the measured value is $13.48\Omega$
0 to $5\text{k}\Omega$	$9.52\Omega$ ( $30\Omega$ range)	$13.48\Omega$ ( $30\Omega$ range)
Above $5\text{k}\Omega$ to $50\text{k}\Omega$	$9.5\Omega$ ( $300\Omega$ range)	$13.5\Omega$ ( $300\Omega$ range)

### Low-resistance measurement

Inspect the probes for any disconnection from the objects being measured.

## 3.16 Clearing Up the Product After Measurement

### CAUTION

- Always fit the measurement terminal covers immediately after use.



Any foreign object entering a measurement terminal could damage the instrument.

- 1** Turn the rotary switch to turn the instrument off.
- 2** Remove the measurement cables from the measurement terminals and fit the measurement terminal covers.
- 3** Remove the measurement cables from the auxiliary earthing rods and pull out the auxiliary earthing rods, taking care not to bend them.  
See “How to pull out the auxiliary earthing rods” (p. 79).
- 4** Rewind the measurement cables (blue, yellow, and red) on the respective winders and put the winders in the carrying case with the auxiliary earthing rods inserted into the winder’s holders.
- 5** Remove the measurement cable (black) from the earth electrode, wrap round it, and put it into the carrying case.  
See “2.1 How to Use the Carrying Case” (p. 31).

## How to pull out the auxiliary earthing rods

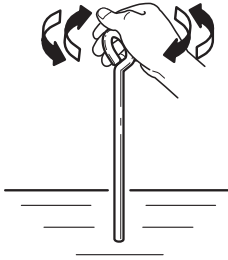

Hold the loop part of an auxiliary earthing rod with your hand and pull it out while turning it.

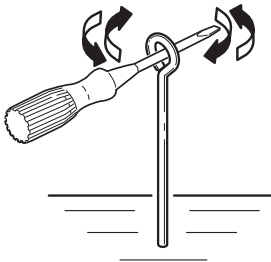

### If it cannot be pulled out by hand

Put a hard metal bar (except the auxiliary earthing rod) through the loop of the auxiliary earthing rod and pull the auxiliary earthing rod while turning it.

Pulling another auxiliary earthing rod put through the loop of the one driven in the ground will cause it to bend.

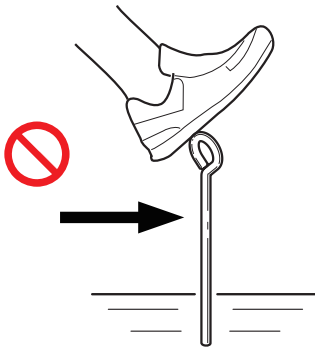

Do not subject the auxiliary earthing rod to force from the side because it will bend.



## 4.1 Continuous Measurement Capability

This capability is convenient when you want to drive the auxiliary earthing rods into the ground while checking measured values.

See “(8) Continuous measurement mode” (p. 110) to find how long you can use the instrument continuously.

### IMPORTANT

- Values measured by the continuous measurement capability may differ from those measured through regular earth-resistance measurement described in “Making measurements” (p. 53).
- Values measured by the continuous measurement capability are for reference purposes only. If you want to measure earth resistance precisely, be sure to measure earth resistance using the measurement method described in “Making measurements” (p. 53).

### To enable the continuous measurement capability

- 1 Set the rotary switch to a function position you want to use.
- 2 Extend the **MEASURE** button.

The instrument measures earth resistance continuously. To switch the on-display parameters during a measurement, turn the continuous measurement capability off, then press the **Fn** button.

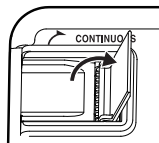

Extend  
(continuous  
measurement)

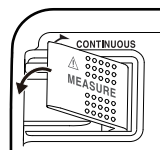

Retract (or release)

### To turn the continuous measurement capability off

- 1 Retract the **MEASURE** button during the continuous measurement.  
The continuous measurement stops.

## 4.2 Zero-Adjustment Capability

The zero adjustment can cancel resistance values that should be removed from measured values, such as the wiring resistance of the test leads. For accurate earth-resistance measurements, execute a zero adjustment, allowing the instrument to display the **0Ω ADJ** symbol. However, two-clamp measurement does not require zero adjustment.

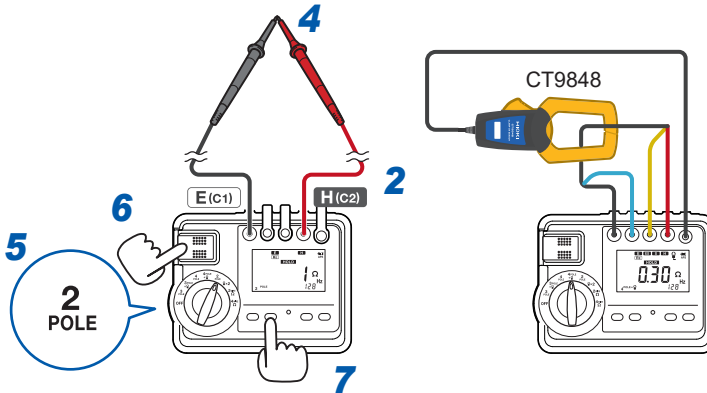

- 1** Remove the measurement terminal covers.
- 2** Connect the measurement cables to the measurement terminals.
- 3** When using the MEC function, clamp CT9848 Clamp on Sensor around the measurement cable as illustrated so that the cable is at the sensor-aperture center.
- 4** Short-circuit the tips of the measurement cables.
- 5** Set the rotary switch to a function position you want to use.

The instrument displays the **0Ω ADJ** symbol when it has been zero-adjusted. Hold the **SET** button (**0ΩADJ** button) for 1 s or more to cancel the previous zero adjustment.

## 6 Press the **MEASURE** button.

The instrument displays a measured value of approx.  $0\ \Omega$  and the **HOLD** symbol.

When a terminal symbol blinks under the measurement terminals, the measurement cable may not have been connected to the relevant measurement terminal, or either cable may have a break.

Check the connection and perform a continuity check with an instrument, such as a tester.

## 7 Hold the **SET** button (**0 $\Omega$ ADJ** button) for 1 s or more.

The zero adjustment is completed and the **0 $\Omega$  ADJ** symbol appears.

### IMPORTANT

In the following cases, execute a zero adjustment again.

- When the test leads are changed
- When the ambient temperature has changed by  $1^\circ\text{C}$  or more
- When the fuses are replaced

4

## How to cancel the previous zero adjustment

Hold the **SET** button (**0 $\Omega$ ADJ** button) for 1 s or more while the **0 $\Omega$  ADJ** symbol is displayed. The zero adjustment is canceled and the **0 $\Omega$  ADJ** symbol is hidden.

## If an error is displayed

The instrument has a zero-adjustment acceptable scope of  $10\ \Omega$  or less for earth-resistance measurement and  $3\ \Omega$  or less for low-resistance measurement. If the measured value exits the acceptable range, the instrument does not execute a zero adjustment, displaying the **[Err]** message and the **0 $\Omega$  ADJ** symbol.

### 4.3 Setting Up the Comparator and Defining the Measurement Conditions

The instrument has a comparator capability, giving pass and fail judgments by displaying them and producing beeps. The comparator capability is available for two types of measurement: earth-resistance measurement and low-resistance measurement.

- 1 Press the **SET** button (**0ΩADJ** button) several times while the instrument is on to find the comparator setting screen.

Every time the **SET** button (**0ΩADJ** button) is pressed, the display switches.

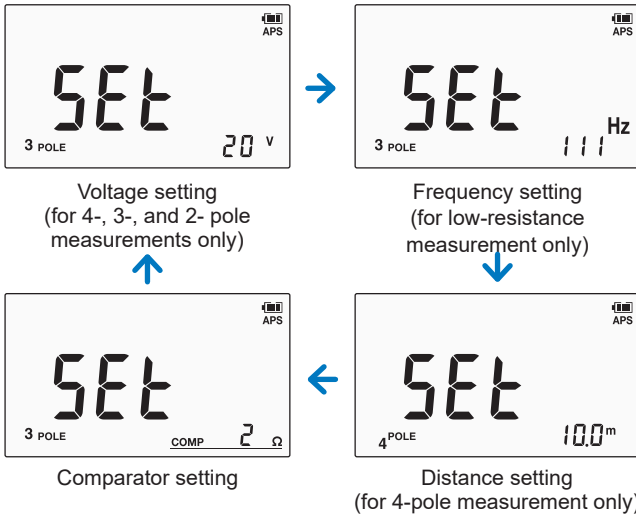

## 2 Press the ▲ or ▼ button to change the settings.

SET button intended setting	▲/▼ button
<b>Voltage setting</b> (only for four-, three-, two-pole measurement)	30 V, 20 V (for four-, three-pole measurement) 8 V, 20 V (for two-pole measurement)
<b>Frequency setting</b>	55 Hz, 94 Hz, 105 Hz, 111 Hz, 128 Hz
<b>Distance setting</b> (only for four-pole measurement)	0.1 m to 50.0 m (settable in increments of 0.1 m) 3 ft. to 160 ft. (settable in increments of 1 ft.) To change the unit to foot (ft.), see “Changing the unit of length” (p. 58)
<b>Comparator setting</b>	1 $\Omega$ to 500 $\Omega$ (in steps of 1 $\Omega$ ) or the off setting

## 3 Set up the comparator.

Measuring earth resistance does not need the comparator setting.

The comparator capability operates as follows:

Judgment criteria	Symbol	Beep
Measured value $\leq$ Reference value (pass)	<b>PASS</b>	Three intermittent tones
Measured value $>$ Reference value (fail)	<b>FAIL</b>	Three longer tones

Default value: 100  $\Omega$

The instrument retains the comparator setting even after it is turned off.

## To turn the comparator off

- 1 With the instrument on, press the **SET** button several times to display the comparator screen.  
The **[COMP]** symbol turns on.
- 2 Press the ▼ button several times until the **[oFF]** message is displayed.
- 3 Press the **[Fn]** or **MEASURE** button to return to the measurement screen.

## 4.4 Power-Saving Capability (Auto-Power Saving Mode)

The instrument automatically enters auto-power saving mode after about 10 minutes of inactivity or after the same period following the last lighting or flashing of the live-line warning indicator (⚡), turning off the display.

The connection to GENNECT Cross cancels the power-saving capability.

### How to return the instrument from auto-power saving mode

Turn the instrument off by turning the rotary switch, then turn it on. The instrument returns from auto-power saving mode, turning the LCD display on.

### How to turn the power-saving capability off

Turn the rotary switch to turn the instrument off and turn the rotary switch while holding the ▲ button to turn the instrument on. The power-saving capability is turned off.

#### IMPORTANT

- The instrument cannot retain the power-saving setting.
- After use, always turn the rotary switch to turn the instrument off. Even in auto-power saving mode, the instrument slightly drains the batteries.

### Automatic backlight-off capability

The instrument turns the backlight off automatically after about 40 s of inactivity.

When you are working continuously in a dark place, cancel the automatic backlight-off capability.

### How to cancel the Automatic backlight-off capability

With the instrument off, turn the rotary switch while the Fn button (backlight button) is held.

## 4.5 Wireless Communications Capability (GENNECT Cross)

Turning the wireless communications capability on allows you to review measurement data and create measurement reports on mobile devices. Visit the GENNECT Cross website for more information.

### **1 Install the Z3210 Wireless Adapter (optional) in the instrument.**

See “2.3 Connecting the Z3210 Wireless Adapter” (p. 35).

### **2 Install GENNECT Cross on your mobile device.**

### **3 Turn the instrument on.**

### **4 Hold the hold the ▼ and ▲ buttons simultaneously for 1 s or more to enable the wireless communications capability.**

Once the wireless communications capability is turned on, the  symbol appears on the display.

Blink: connected to a mobile device

On: communications capability turned on

Off: communications capability turned off

To turn the wireless communications capability on and off, hold the ▼ and ▲ buttons at a time for 1 s or more.

### **5 Start GENNECT Cross and register the instrument as an instrument to be connected.**

### **6 Choose capabilities you want to use and start a measurement.**

- A mobile device and instruments can communicate over a line-of-sight distance of up to about 10 m. The communicable distance varies greatly depending on whether there are any obstructions between the paired instrument (for example, walls, and metal barriers) and the distance between the instrument and the floor (or ground). Make sure that the signal has a sufficient strength for stable communications.
- Although GENNECT Cross is available free of charge, you will be subject to Internet connection charges when downloading or using the application software.
- GENNECT Cross may not run on some mobile devices.
- The Z3210 uses the 2.4 GHz band wireless technology. Some devices may be unable to establish a wireless connection near other devices that use the same

frequency band, such as Wi-Fi (IEEE 802.11.b/g/n).

- When the app starts for the first time (before being paired with any instrument), the instrument settings screen is displayed.
- A mobile device that displays the GENNECT Cross's instrument settings screen can automatically pair with nearby instruments (the app can be paired with up to eight instruments).
- Allow 5 s to 30 s for the instrument to pair with the app after the instrument is turned on. If the instrument fails to pair within 1 min., restart GENNECT Cross and turn it off and then on.

## 4.6 Z3210-to-Excel Direct Data Entry Function (Excel Direct Input Function, HID Function)

The human interface device (HID) profile, the Z3210 Wireless Adapter includes, is the profile same as that wireless keyboards use.

Preparatory to data entry, open an Excel spreadsheet on your mobile device or computer and choose a cell. Freezing the instrument's display can enter the measured value on the cell.



<b>When HID is on</b>	Measured values can be entered in an Excel spreadsheet or a text file. The instrument cannot communicate with GENNECT Cross.
<b>When HID is off</b>	GENNECT Cross can be used.

### Turning the HID function on and off

The instrument does not maintain the HID on/off setting, but the Z3210 does.

- 1** Turn the rotary switch to turn the instrument off.
- 2** Install the **Z3210 Wireless Adapter (optional)** into the instrument.  
See “2.3 Connecting the Z3210 Wireless Adapter” (p. 35).
- 3** Turn the instrument on by turning the rotary switch while pressing the ▼ and ▲ buttons.
- 4** Press the ▼ and ▲ buttons to choose between the [on] and [off] messages.
- 5** Press the **SET** button to confirm.  
The instrument is turned off automatically.

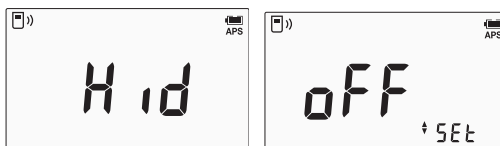

## If the [oLd] message is displayed

Update the Z3210 to the latest version using GENNECT Cross (version 1.8 or later).

### IMPORTANT

To switch over from the HID function to GENNECT Cross

If you start GENNECT Cross without canceling the pairing between the mobile device and the instrument, GENNECT Cross may be unable to recognize the instrument as a connectible device.

Follow the procedure below to reconnect the instrument to GENNECT Cross.

1. Use the **Bluetooth®** setting of your mobile device to delete the instrument.
2. Turn off the HID function of the Z3210.
3. Use the Instrument Setting of GENNECT Cross to reconnect the instrument.

## Confirming the HID setting

- 1 Turn on the instrument by turning the rotary switch while pressing the ▼ and ▲ buttons.

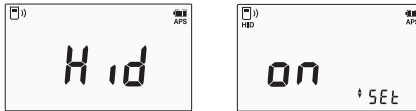

- 2 Turn the rotary switch to turn the instrument off.

Visit the Z3210 website for more information at <https://z3210.gennect.net>.

<https://z3210.gennect.net>



Learn more here!

## 4.7 Displaying All Segments on the Display

This section describes how to check for the screen issues by displaying all segments on the display.

- 1** Turn on the instrument by turning the rotary switch while pressing the **SET** button.
- 2** Set the rotary switch to the **4POLE** position while the instrument displays the serial number.
- 3** Check if all segments are displayed and the live-line warning indicator (⚡) is turned on.
- 4** Press any button.  
The instrument enters normal measurement mode.

4

## 4.8 Displaying the Serial Number

This section describes how to check the serial number.

- 1** Turn the instrument on by turning the rotary switch while pressing the **SET** button.  
The first six digits and the last three digits of the serial number (nine digits in total) are displayed alternately.
- 2** Press any button.  
The instrument enters normal measurement mode.

The serial number consists of nine digits. The first two digits indicate the year of manufacture, while the second two digits indicate the month of manufacture.

Example in the figure below: manufactured in December 2023

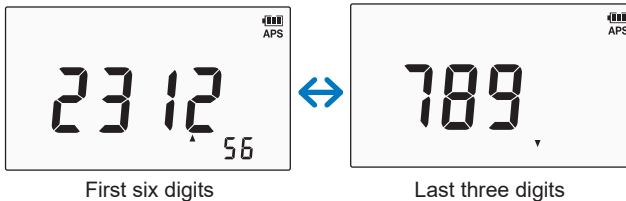

(Example of a serial number: 231256789)

## 4.9 Displaying the Firmware Version Number

This section describes how to check the firmware version number installed in the instrument.

- 1 Turn the instrument on by turning the rotary switch while pressing the **SET** button.
- 2 Set the rotary switch to the **3POLE+Clamp** position while the instrument displays the serial number.



- 3 Turn the rotary switch to turn the instrument off.

### Firmware updating capability

---

The firmware of the instrument can be updated using GENNECT Cross (free-of-charge application). For more information, see GENNECT Cross website.

#### Requirement

GENNECT Cross	Version 1.8 or later
Instrument firmware	Version 2.00 or later

# 5 Specifications

## 5.1 General Specifications

<b>Operating environment</b>	Indoor use, outdoor use excluding in farmland (according to the requirements regarding the limitation on open-circuit voltage in EN 61557-5) Pollution degree 3, altitude up to 2000 m (6562 ft.)
<b>Operating temperature and humidity range</b>	In the range of -25°C to 40°C (-13°F to 104°F) 80% RH or less (non-condensing) In the range of 40°C to 45°C (104°F to 113°F) 60% RH or less (non-condensing) In the range of 45°C to 50°C (113°F to 122°F) 50% RH or less (non-condensing) In the range of 50°C to 55°C (122°F to 131°F) 40% RH or less (non-condensing) In the range of 55°C to 60°C (131°F to 140°F) 30% RH or less (non-condensing) In the range of 60°C to 65°C (140°F to 149°F) 25% RH or less (non-condensing)
<b>Storage temperature and humidity range</b>	-25°C to 65°C (-13°F to 149°F) 80% RH or less (non-condensing)
<b>Dust resistance and water resistance</b>	IP65/IP67 (EN 60529) The instrument, with its measurement terminals protected by the terminal covers of the protector, features an enclosure with a protection rating of IP65/IP67 (according to EN 60529).  IP65/IP67: Indicates the degrees of protection provided by the enclosure of the instrument against use in hazardous locations, entry of solid foreign objects, and the ingress of water.  IP6X: Protected against access to hazardous parts with wire measuring 1.0 mm in diameter. Dust-proof type (Dust shall not penetrate the enclosure.)  IPX5: The equipment inside the enclosure is protected against the harmful effects of water projected in jets against the enclosure from any direction.  IPX7: Watertight (Quantities of water that may harm the enclosure when it is temporarily immersed in water shall not penetrate the enclosure.)
<b>Drop-proof functionality</b>	Drop height: 1 m, impact surface: concrete (when covered with the protector) The instrument with nickel-metal hydride batteries inserted is not drop-proof.

<b>Standards</b>	<ul style="list-style-type: none"> <li>• Safety EN 61010</li> <li>• EMC EN 61326</li> <li>• Electrical safety in low voltage distribution systems up to 1 000 V a.c. and 1 500 V d.c. EN 61557-1 EN 61557-10</li> <li>• Low resistance EN 61557-4</li> <li>• Earth tester EN 61557-5</li> </ul>
<b>Applicable standards</b>	<p>Earth tester: JIS C 1304:2002 (withdrawn standard)</p> <ul style="list-style-type: none"> <li>• Items quoted from the withdrawn safety standard JIS C 1010-1:1998 and JIS C 1010-2-31:1998 are replaced with those of the safety standard described in <i>Standards</i> of this specifications. (for example, 5.2 Safety voltage, 5.7 Terminals, 5.13 Accessories, and 5.14 Safety)</li> <li>• Designations of 1) <i>Terminals</i> in 6.1 <i>Display</i> is replaced with those in EN 61557-5.</li> </ul>
<b>Power supply</b>	<p>Use either of the following:</p> <ul style="list-style-type: none"> <li>• HR6 Nickel-metal hydride battery ×4</li> <li>• LR6 Alkaline battery ×4</li> </ul> <p>Rated supply voltage: 1.2 V DC × 4 or 1.5 V DC × 4 Maximum rated power: 3 VA Available effective battery voltage: 4.4 V ±0.19 V to 6.9 V</p>
<b>Number of measurements that can be made</b>	<p>When four HR6 Nickel-metal hydride batteries (1900 mAh capacity each) or four LR6 Alkaline batteries are used (reference value at 23°C)</p> <p>500 times (three-pole measurement, an auxiliary earth resistance of 100 Ω, measuring a resistance of 10 Ω using the 30 Ω range, measurements started at intervals of 10 s, without the Z3210 installed)</p> <p>400 times (three-pole measurement, an auxiliary earth resistance of 100 Ω, measuring a resistance of 10 Ω using the 30 Ω range, measurements started at intervals of 10 s, with the Z3210 installed, using wireless communications)</p>
<b>Dimensions</b>	<p>Approx. 189W × 148H × 48D mm (7.4W × 5.8H × 1.9D in.) (including the protector, excluding the measurement terminal covers)</p>
<b>Weight</b>	<p>Approx 765 g (27 oz.) (including batteries and the protector, excluding other accessories)</p>
<b>Product warranty period</b>	<p>3 years</p>
<b>Accessories</b>	<p>See “Checking Package Contents” (p.8).</p>
<b>Optional equipment</b>	<p>See “Optional Equipment (Sold Separately)” (p.9).</p>

## 5.2 Input, Output, and Measurement Specifications

### Basic and accuracy specifications

<b>Measurement functions</b>	<ul style="list-style-type: none"> <li>• Earth-resistance measurement Four-pole measurement, three-pole measurement, two-pole measurement, earth-resistance clamp-using measurement (MEC) function, two-clamp measurement</li> <li>• Low-resistance measurement Four-terminal measurement, two-terminal measurement, DC application, voltage detection</li> <li>• Ground-potential measurement</li> </ul>
<b>Input/output terminals</b>	<ul style="list-style-type: none"> <li>• H (C2) terminal Used to output the measurement voltage, output the measurement signal during the two-clamp measurement, and detect voltage across an object under measurement during the two-pole measurement.</li> <li>• S (P2) terminal Used to detect the voltage across an object under measurement (the two-pole measurement does not use).</li> <li>• ES (P1) terminal Used to detect the voltage across an object under measurement (the three-pole and two-pole measurements do not use).</li> <li>• E (C1) terminal Used to connect to the earth electrode of an object under measurement and receive the measurement current output from the H (C2) terminal.</li> <li>• Clamp terminal Used to detect the current during MEC measurement.</li> </ul>
<b>Maximum rated line-to-ground voltage</b>	<p>100 V AC/DC (measurement category IV)  150 V AC/DC (measurement category III)  300 V AC/DC (measurement category II)  Anticipated transient overvoltage: 2500 V</p>

---

<b>Rated operating conditions</b>	<ul style="list-style-type: none"><li>• Operating temperature and humidity range See "Operating temperature and humidity range" (p.93) in "General Specifications."</li><li>• Attitude Horizontal <math>\pm 90^\circ</math></li><li>• Power supply voltage Same as the effective battery voltage range See "Available effective battery voltage" under "Power supply" (p.94).</li><li>• Ground potential See "Effects of ground potential (E4)" (p. 100).</li><li>• Resistance of auxiliary earth electrode See "Acceptable resistance of auxiliary earth electrodes*6" (p.98).</li><li>• External magnetic field 400 A/m or less, DC and a frequency of 50 Hz and 60 Hz</li></ul>
<b>Accuracy guarantee conditions</b>	Accuracy guarantee duration: 1 year Accuracy guarantee temperature and humidity range: 23°C $\pm 5^\circ\text{C}$ (73°F $\pm 9^\circ\text{F}$ ), 80% RH or less

---

## Earth-resistance measurement (four-pole measurement, three-pole measurement, two-pole measurement)

$R_E$ : earth resistance of an object under measurement  
(for four-pole measurement, earth resistance of the E pole)

$R_H$ : earth resistance of the H pole

$R_{ES}$ : earth resistance of the ES pole

$R_S$ : earth resistance of the S pole

Conditions: measurement with an auxiliary earth electrode resistance of  $100\ \Omega \pm 5\%$  and a ground potential of 0 V

<b>Measurement principal</b>	<ul style="list-style-type: none"> <li>Voltage application</li> <li>Voltage and current measurement (Effective resistance is measured by synchronous detection.)</li> </ul>
<b>Measurement method</b>	Four-pole measurement, three-pole measurement, and two-pole measurement
<b>Output voltage</b>	<p>Four-pole measurement and three-pole measurement</p> <p>The following voltage ranges can be switched:</p> <ul style="list-style-type: none"> <li>Not more than 30 V rms and not more than 42.4 V peak</li> <li>Not more than 20 V rms and not more than 28.3 V peak</li> </ul> <p>Two-pole measurement</p> <p>The following voltage ranges can be switched:</p> <ul style="list-style-type: none"> <li>Not more than 8 V rms</li> <li>Not more than 20 V rms and not more than 28.3 V peak</li> </ul>
<b>Measurement current</b>	<ul style="list-style-type: none"> <li>Four-pole measurement 25 mA rms or less (for an output voltage of 30 V) 15 mA rms or less (for an output voltage of 20 V)</li> <li>Three-pole measurement 25 mA rms or less (for an output voltage of 30 V) 15 mA rms or less (for an output voltage of 20 V)</li> <li>Two-pole measurement 4 mA rms or less (for an output voltage of 8 V) 15 mA rms or less (for an output voltage of 20 V)</li> </ul>
<b>Measurement current waveform</b>	Sine wave (with a distortion factor of 5% or less)
<b>Measuring frequency</b>	94 Hz $\pm 2$ Hz, 105 Hz $\pm 2$ Hz, 111 Hz $\pm 2$ Hz, 128 Hz $\pm 2$ Hz, 55 Hz $\pm 2$ Hz
<b>Measurement time</b>	<ul style="list-style-type: none"> <li>Four-pole measurement 9 s or less (19 s or less for a measurement frequency of 55 Hz)</li> <li>Three-pole measurement 6 s or less (13 s or less for a measurement frequency of 55 Hz)</li> <li>Two-pole measurement 3 s or less (5 s or less for a measurement frequency of 55 Hz)</li> </ul>

### Range configuration (auto-ranging)

Range <sup>*1*2</sup>		3 Ω	30 Ω	300 Ω
Applicable conditions (three-pole measurement, $R_E$ and $R_H$ )	$R_E$	3 Ω or less	30 Ω or less	300 Ω or less
	$R_H$	5 kΩ or less	5 kΩ or less	50 kΩ or less
Applicable conditions (four-pole measurement)	$R_H + R_E$ or $R_{ES} + R_E$			
Display range		0.000 Ω to 3.000 Ω	0.00 Ω to 30.00 Ω	0.0 Ω to 300.0 Ω
Fiducial value		3 Ω	30 Ω	300 Ω
Resolution	Four-pole	0.001 Ω	0.01 Ω	0.1 Ω
	Three-pole	0.001 Ω	0.01 Ω	0.1 Ω
	Two-pole	–	–	1 Ω
Accuracy <sup>*3</sup> (intrinsic uncertainty A)		±1.5% rdg ±0.06 Ω <sup>*4</sup>		±1.5% rdg ±4 dgt <sup>*5</sup>
Acceptable resistance of auxiliary earth electrodes <sup>*6</sup>	Range	–	30 Ω	300 Ω
	$R_H$ Three-pole measurement $R_H + R_E$ Four-pole measurement		5 kΩ	50 kΩ
	$R_S$ Three-pole measurement		1 MΩ	
	$R_S + R_{ES}$ Four-pole measurement			
<b>Items related to EN 61557-5</b>				
Operation uncertainty		±30% rdg (applicable to three-pole and four-pole measurements)		
Guaranteed range of operation uncertainty		5.00 Ω to 300.0 kΩ (the range in which operation uncertainty within ±30% is guaranteed, applicable to four-pole measurement or three-pole measurement)		

	3000 $\Omega$	30.00 k $\Omega$	300.0 k $\Omega$	Range* <sup>1</sup> * <sup>2</sup>	
3 k $\Omega$ or less	Over 3 k $\Omega$ to 30 k $\Omega$	Over 30 k $\Omega$ to 300 k $\Omega$	$R_E$	$R_H$	Applicable conditions (three-pole measurement, $R_E$ and $R_H$ )
100 k $\Omega$ or less	100 k $\Omega$ or less	100 k $\Omega$ or less	$R_H$		
Over 50 k $\Omega$	Over 50 k $\Omega$	Over 50 k $\Omega$	$R_H+R_E$ or $R_{ES}+R_E$		Applicable conditions (four-pole measurement)
0 $\Omega$ to 3000 $\Omega$	3.00 k $\Omega$ to 30.00 k $\Omega$	30.0 k $\Omega$ to 300.0 k $\Omega$	Display range		
3000 $\Omega$	30.00 k $\Omega$	300.0 k $\Omega$	Fiducial value		
1 $\Omega$	0.01 k $\Omega$	0.1 k $\Omega$	Four-pole		Resolution
1 $\Omega$	0.01 k $\Omega$	0.1 k $\Omega$	Three-pole		
1 $\Omega$	0.01 k $\Omega$	0.1 k $\Omega$	Two-pole		
$\pm 1.5\% \text{ rdg} \pm 4 \text{ dgt}^{*5}$			Accuracy* <sup>3</sup> (intrinsic uncertainty A)		
3000 $\Omega$	30.00 k $\Omega$	300.0 k $\Omega$	Range		Acceptable resistance of auxiliary earth electrodes* <sup>6</sup>
100 k $\Omega$			$R_H$ Three-pole measurement		
			$R_H + R_E$ Four-pole measurement		
1 M $\Omega$			$R_S$ Three-pole measurement		
			$R_S + R_{ES}$ Four-pole measurement		
<b>Items related to EN 61557-5</b>					
$\pm 30\% \text{ rdg}$ (applicable to three-pole and four-pole measurements)			Operation uncertainty		
5.00 $\Omega$ to 300.0 k $\Omega$ (the range in which operation uncertainty within $\pm 30\%$ is guaranteed, applicable to four-pole measurement or three-pole measurement)			Guaranteed range of operation uncertainty		

- \*1. The 3Ω and 30Ω ranges can be used for the three-pole and four-pole measurement only.
- \*2. The smallest range that meets the applicable conditions is automatically selected.
- \*3. Applicable after a zero adjustment. A value of ±0.3Ω is added if a zero adjustment have not been executed (when using the L9841).
- \*4. Reference: ±1.7% at the maximum displayable value (JIS C 1304 requires ±5% f.s.)
- \*5. Reference: ±1.6% at the maximum displayable value (JIS C 1304 requires ±5% f.s.)
- \*6. Not applicable to the two-pole measurement. The upper limit is equal to the acceptable resistance of the auxiliary earth electrode.

<b>Effects of attitude (E<sub>1</sub>)</b>	Not applicable to a digital-type instrument
<b>Effects of supply voltage (E<sub>2</sub>)</b>	Accuracy × 0.5 and within accuracy specifications
<b>Effects of temperature (E<sub>3</sub>)</b>	Accuracy × 1.0 (0°C to 50°C) Accuracy × 2.0 (-25°C to 0°C, 50°C to 65°C) Applicable to temperatures excluding a range of 18°C to 28°C
<b>Effects of ground potential (E<sub>4</sub>)</b>	16 $\frac{2}{3}$ Hz, 50 Hz, 60 Hz For a ground potential of 0 V to 3 V Accuracy × 1.0 (for a measurement frequency of 55 Hz, Accuracy × 5.0) For a ground potential of 3 V to 30 V Accuracy × 2.0 (for a measurement frequency of 55 Hz, Accuracy × 10.0)
	DC For a ground potential of 0 V to 3 V Accuracy × 1.0 (for a measurement frequency of 55 Hz, Accuracy × 5.0) For a ground potential of 3 V to 10 V Accuracy × 2.0 (for a measurement frequency of 55 Hz, Accuracy × 10.0)
	400 Hz For a ground potential of 0 V to 3 V Accuracy × 1.0 For a ground potential of 3 V to 5 V Accuracy × 2.0
<b>Acceptable ground potential</b>	30V rms or 42.4 V peak
<b>Effects of the resistance of the auxiliary earth electrode (E<sub>5</sub>)</b>	With any one of Electrodes R <sub>H</sub> , R <sub>S</sub> , R <sub>ES</sub> , and R <sub>E</sub> or the sum of them Variable For a resistance of 10 kΩ or less Accuracy × 1.0 For a resistance of more than 10 kΩ to 100 kΩ Accuracy × 2.0 For a resistance of more than 100 kΩ Accuracy not specified Not applicable to the two-pole measurement. The upper limit is equal to the acceptable resistance of the auxiliary earth electrode.
<b>Effects of system frequency (E<sub>7</sub>)</b>	Not applicable
<b>Effects of system voltage (E<sub>8</sub>)</b>	Not applicable

<b>Effects of external magnetic field</b>	Accuracy × 0.5				
<b>Auto-checking on earth resistance of the auxiliary earth electrodes (automatically start checking after measurements start)</b>	Display range	1000 Ω	10 kΩ	100 kΩ	1000 kΩ
	Maximum displayable value	1000 Ω	10.0 kΩ	100 kΩ	1000 kΩ
	Resolution	10 Ω	0.1 kΩ	1 kΩ	10 kΩ
	Accuracy	Not specified			
	<ul style="list-style-type: none"> <li>• The instrument can display up to 200 kΩ for <math>R_H</math> and <math>R_E</math>.</li> <li>• When the display range for any auxiliary earth electrode switches to the 1000 kΩ range, those for the other auxiliary earth electrodes switch to the 10 kΩ range or higher.</li> </ul>				
<b>Auto-checking on ground potential (automatically start checking after measurements start)</b>	<ul style="list-style-type: none"> <li>• Capability to check if of the ground potential is within the acceptable range</li> <li>• If the ground potential is not acceptable, the instrument does not make earth-resistance measurements, activating the live-line warning indicator.</li> </ul>				
<b>Overload protection</b>	360 V AC (for 1 min., between each terminal and the others) 360 V DC (for 1 min., between each terminal and the others)				
<b>Automatic measurement termination</b>	The measurement automatically stops after the measured value is finalized.				
<b>Effect of line-to-earth capacity (two-pole measurement)</b>	<p>Specified for a resistance of 3000 Ω or less For a capacitance of 10 nF or less Within accuracy specifications For a capacitance of more than 10 nF to 500 nF Accuracy × 2.0 For a capacitance of more than 500 nF Not specified Parallel capacitance is canceled from impedance and phase. Calculated by the following equation.</p> $R = \left  \frac{Z}{\cos \theta} \right $ <p>(correction applied only when <math>\theta</math> is negative) (<math>\theta</math>: difference between the measurement current phase and voltage signal phase; the <b>[&gt;300.0]</b> message blinks and the <b>[kΩ]</b> segment appears when <math>\theta</math> is 90°.)</p>				
<b>Zero-adjustable range</b>	10 Ω or less				
<b>Negative-resistance value processing</b>	Displays absolute values.				

## MEC function (four-pole measurement using a clamp, three-pole measurement using a clamp)

$R_E$ : earth resistance of an object under measurement

$R_H$ : earth resistance of the H pole

$R_{ES}$ : earth resistance of the ES pole

$R_S$ : earth resistance of the S pole

Conditions

Measurement with an auxiliary earth electrode resistance of  $100\Omega \pm 5\%$  and a ground potential of 0 V

<b>Measurement principal</b>	Voltage application, voltage and current measurement (effective resistance measurement using synchronous detection)
<b>Measurement method</b>	Switchable between the three-pole and four-pole measurements
<b>Output voltage</b>	Switchable between the following: <ul style="list-style-type: none"> <li>• Not more than 30 V rms and 42.4 V peak</li> <li>• Not more than 20 V rms and 28.3 V peak</li> </ul>
<b>Measurement current</b>	Four-pole measurement 25 mA rms or less 15 mA rms or less (for an output voltage of 20 V)
	Three-pole measurement 25 mA rms or less 15 mA rms or less (for an output voltage of 20 V)
<b>Measurement current waveform</b>	Sine wave (with a distortion factor of 5% or less)
<b>Measuring frequency</b>	94 Hz $\pm 2$ Hz, 105 Hz $\pm 2$ Hz, 111 Hz $\pm 2$ Hz, 128 Hz $\pm 2$ Hz, 55 Hz $\pm 2$ Hz
<b>Measurement time</b>	Four-pole measurement 12 s or less (22 s or less for a measurement frequency of 55 Hz)
	Three-pole measurement 8 s or less (16 s or less for a measurement frequency of 55 Hz)
<b>Influence quantity</b>	See "Range configuration (auto-ranging)" (p.98). The influence quantity conform to that of earth-resistance measurement, as well as the four-pole, three-pole, and two-pole measurement.
<b>Zero-adjustment applicable range</b>	10 $\Omega$ or less

## Range configuration (auto-ranging)

Range* <sup>1</sup>		30 $\Omega$	300 $\Omega$	3000 $\Omega$	30.00 k $\Omega$
Applicable conditions ( $R_E$ and $R_H$ )	$R_E$	30 $\Omega$ or less	300 $\Omega$ or less	3 k $\Omega$ or less	Over 3 k $\Omega$ but 30 k $\Omega$ or less
	$R_H$	5 k $\Omega$ or less	50 k $\Omega$ or less	100 k $\Omega$ or less	100 k $\Omega$ or less
Displayable scope		0.00 $\Omega$ to 30.00 $\Omega$	0.0 $\Omega$ to 300.0 $\Omega$	0 $\Omega$ to 3000 $\Omega$	3 k $\Omega$ to 30.00 k $\Omega$
Resolution		0.01 $\Omega$	0.1 $\Omega$	1 $\Omega$	0.01 k $\Omega$
Accuracy* <sup>2</sup> (intrinsic uncertainty A)		$\pm 5\%$ rdg $\pm 6$ dgt	$\pm 5\%$ rdg $\pm 3$ dgt		
Acceptable resistance of auxiliary earth electrodes* <sup>3</sup>	$R_H$	5 k $\Omega$	50 k $\Omega$	100 k $\Omega$	
	$R_S$ Three-pole measurement	1 M $\Omega$			
	$R_S + R_{ES}$ Four-pole measurement				

\*1. The smallest range that meets both the  $R_H$  and  $R_E$  values is automatically selected.

\*2. Applicable after a zero adjustment

\*3. The upper limit is equal to the acceptable resistance of the auxiliary earth electrode.

## Two-clamp earth-resistance measurement

<b>Accuracy guarantee conditions</b>	No reactance components included, no noise current superimposed, at a ground potential of 0 V		
<b>Measurement principle</b>	Voltage application, voltage and current measurement (effective resistance measurement using synchronous detection)		
<b>Inter-clamp distance</b>	150 mm or more		
<b>Effective measurement range</b>	0.02 $\Omega$ to 200 $\Omega$		
<b>Zero-display range</b>	Less than 0.02 $\Omega$		
<b>Over-range</b>	More than 500 $\Omega$		
<b>Frequency of the signal to be injected</b>	94 Hz $\pm$ 2 Hz, 105 Hz $\pm$ 2 Hz, 111 Hz $\pm$ 2 Hz, 128 Hz $\pm$ 2 Hz		
<b>Level of the voltage to be injected</b>	14.25 mV $\pm$ 1.0 mV rms (when the conductor around which the FT9847 Signal Induction Clamp is clamped is open-circuited)		
<b>Measurement time</b>	Within 3 s		
<b>Waveform to be measured</b>	Sine wave (with a distortion factor of 5% or less)		
<b>Effects of attitude (<math>E_1</math>)</b>	Accuracy $\times$ 2.0		
<b>Reference position <math>\pm 90^\circ</math></b>			
<b>Effects of supply voltage (<math>E_2</math>)</b>	Accuracy $\times$ 0.5 and within accuracy specifications		
<b>Effects of temperature (<math>E_3</math>)</b>	Accuracy $\times$ 1.0 (within a temperature range of 18°C to 28°C), Accuracy $\times$ (1 + 0.1) (within temperature ranges of -25°C to 18°C and 28°C to 65°C)		
<b>Effects of ground potential (<math>E_4</math>)</b>	16 $\frac{2}{3}$ Hz, 50 Hz, 60 Hz	0 V to 3 V	Accuracy $\times$ 1.0
	DC	0 V to 3 V	Accuracy $\times$ 1.0
	400 Hz	0 V to 3 V	Accuracy $\times$ 1.0
<b>Acceptable ground potential</b>	3 V rms (direct current or sine wave)		
<b>Effects of the resistance of the auxiliary earth electrodes (<math>E_5</math>)</b>	Not applicable		
<b>Effects of system frequency (<math>E_7</math>)</b>	Not applicable		
<b>Effects of system voltage (<math>E_8</math>)</b>	Not applicable		

**Range configuration (auto-ranging)**

Range	20.00 $\Omega$	200.0 $\Omega$	500 $\Omega$
Accuracy range	0.02 $\Omega$ to 20.00 $\Omega$	20.0 $\Omega$ to 200.0 $\Omega$	200 $\Omega$ to 500 $\Omega$
Fiducial value	20 $\Omega$	200 $\Omega$	Not specified
Resolution	0.01 $\Omega$	0.1 $\Omega$	1 $\Omega$
Accuracy (intrinsic uncertainty A)	$\pm 7\%$ rdg $\pm 3$ dgt		$\pm 35\%$ rdg
<b>The accuracy of the higher range is adopted for measured values on a range boundary.</b>			
Operation uncertainty	$\pm 30\%$ rdg		
Guaranteed range of operation uncertainty	3.00 $\Omega$ to 200 $\Omega$		

## Low-resistance measurement

<b>Open-circuit voltage</b>	4.0V to 6.9V
<b>Measurement current</b>	200 mA or more (when the display reads 4Ω or less before a zero adjustment)
<b>Response time</b>	Within 3 s (from the time the open input terminals are short-circuited.)
<b>Number of measurements that can be made</b>	200 or more
<b>Overload protection</b>	250 V AC, 10 s (fuse-protected)
<b>Zero-adjustable range</b>	0Ω to 3Ω
<b>Display refresh interval</b>	Within 1 s
<b>Effects of supply voltage (<math>E_2</math>)*<sup>1</sup></b>	±3% rdg ±2 dgt and within tolerance
<b>Effects of temperature (<math>E_3</math>)*<sup>1</sup></b>	±3% rdg ±2 dgt (applicable to an operating temperature range except between 18°C and 28°C)

### Range configuration (auto-ranging)

Range	30 Ω	300 Ω	3000 Ω
<b>Accuracy range</b>	0.00Ω to 30.00Ω	30.0Ω to 300.0Ω	300Ω to 3000Ω
<b>Resolution</b>	0.01Ω	0.1Ω	1Ω
<b>Accuracy (intrinsic uncertainty A)*<sup>1</sup></b>	±3 dgt (0 Ω to 0.19 Ω) ±2% rdg ±2 dgt (0.20 Ω to 30.00 Ω)	±2% rdg ±2 dgt	
<b>Operation uncertainty</b>	±30% rdg		
<b>Guaranteed range of operation uncertainty</b>	0.2Ω to 2Ω		

\*1. Applicable after a zero adjustment  
(Zero adjustment is required when the ambient temperature has changed by 1°C or more.)



## Ground-potential measurement

<b>DC/AC auto-detection range</b>	The instrument displays the AC symbol with no signal input. A ground potential of 0.3 V DC $\pm 0.2$ V or higher is detected as DC. (The manual switching capability provided) Pulsating current with superimposed AC components that periodically zero-crosses is detected as AC.
<b>Measurement principle</b>	True-RMS indication
<b>Terminals for voltage measurement</b>	Four-pole measurement Between the S (P2) terminal (positive) and ES (P1) terminal (negative) <hr/> Three-pole measurement Between the S (P2) terminal (positive) and E (C1) terminal (negative) <hr/> Two-pole measurement Between the H (C2) terminal (positive) and E (C1) terminal (negative)
<b>Overload protection</b>	360 V AC (for 1 min., between each terminal and the others) <hr/> 360 V DC (for 1 min., between each terminal and the others)
<b>Display refresh interval</b>	Within 1 s
<b>Input resistance</b>	4 M $\Omega$ or more (DC, 50 Hz, 60 Hz)
<b>Response time</b>	Within 2 s (when an input voltage is changed from 0 V to 30 V)
<b>Effects of temperature</b>	Accuracy $\times 1.0$ (applicable to a temperature range of $-10^{\circ}\text{C}$ to $50^{\circ}\text{C}$ , excluding between $18^{\circ}\text{C}$ to $28^{\circ}\text{C}$ ) Accuracy $\times 2.0$ (applicable to temperature ranges of $-25^{\circ}\text{C}$ to $-10^{\circ}\text{C}$ and $50^{\circ}\text{C}$ to $65^{\circ}\text{C}$ )
<b>Range configuration</b>	Display range: 30 V <hr/> Maximum displayable value: 30.0 V <hr/> Resolution: 0.1 V <hr/> Accuracy $\pm 1.3\%$ rdg $\pm 4$ dgt for DC $\pm 2.3\%$ rdg $\pm 8$ dgt for 50 Hz and 60 Hz

## 5.3 Capability Specifications

### (1) Battery effective range display

Indicates the inserted-battery level.

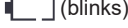
Remaining battery indicator	Battery voltage
	From 5.0V $\pm$ 0.19V
	From 4.7V $\pm$ 0.19V to 5.0V $\pm$ 0.19V
	From 4.4V $\pm$ 0.19V to 4.7V $\pm$ 0.19V
 (blinks)	to 4.4V $\pm$ 0.19V

The instrument with the zero-level battery indication cannot perform measurements, not displaying any measured values.

### (2) Live-line warning indicator



The red LED lights up, flashes on and off, and turns off depending on the inter-terminal voltage and the measurement state.

The red LED does not light when the instrument is off.

### Earth Tester

MEASURE button	Inter-terminal voltage	Applicable terminals and conditions			Message	Live-line warning indicator
		Four-pole	Three-pole	Two-pole		
On	–	–	–	–	Measured resistance value	On
Off	Over 30 V AC Over +30 V DC Under –30 V DC	Between the S (P2) and ES (P1) terminals	Between the S (P2) and E (C1) terminals	Between the H (C2) and E (C1) terminals	When the measured value is within a range of –30.0 V to 30.0 V, the value is displayed. When the measured value exits the above ranges, the <b>&gt; 30 V</b> message (unsigned) is displayed.	Blinks (beeps)

## Low-resistance measurement

MEASURE button	Inter-terminal voltage	Applicable terminals and conditions		Message	Live-line warning indicator
		Two-terminal	Four-terminal		
On	–	–	–	Measured resistance value	On
Off	Over 30 V AC Over +5 V DC Under –5 V	Between the H (C2) and E (C1) terminals	Between the S (P2) and ES (P1) terminals	When the measured value is within a range of 0 V to 30 V AC or –5.0 V to 5.0 V DC, the value is displayed. When the measured value exits the above ranges, either of the following combination is displayed: <ul style="list-style-type: none"> <li>The  symbol and the <b>[&gt; 30 V]</b> message</li> <li>The  symbol and the <b>[5 V]</b> message (unsigned)</li> </ul>	Blinks (beeps)

5

### (3) Power-saving capability (auto-power saving mode)

- When it is on, the instrument enters auto-power saving mode after 10 minutes  $\pm 1$  minute of inactivity or after the same period following the last lighting up or flashing on and off of the live-line warning indicator.
- How to turn the power-saving capability off  
A rotary-switch combination can turn the capability off.
- To return the instrument from auto-power saving mode  
Turn the instrument off by turning the rotary switch, then turn it again.

### (4) Ground resistivity ( $\rho$ ) display (for four-pole measurement only)

The ground resistivity is calculated from the distance of the auxiliary earth electrode entered on the setting screen ( $L$ ) and the resistance value ( $R$ ), then displayed.

$$\rho = 2\pi LR$$

The unit of length can be switched between the two kinds of units: meter (m) and foot (ft).

Procedure

- While holding the **SET** button, turn the instrument on.
- While the serial number is displayed, hold the **SET** button until the **[Unit]** message appears.
- Use the **▲** and **▼** buttons to switch between the two kinds of units: meter (m) and foot (ft).
- Press the **SET** button to confirm. The screen changes to the measurement screen.

## (5) Zero adjustment

Executing a zero adjustment can cancel the residual resistance of test leads used for the earth-resistance measurement.

The residual resistance is canceled from the stored measurement values obtained by the following ways:

---

### Four-pole measurement, four-pole measurement using a clamp, low-resistance measurement (four-terminal)

---

Test leads are connected to the E (C1), ES (P1), S (P2), and H (C2) terminals to measure wiring resistance.

---

### Three-pole measurement, three-pole measurement using a clamp

---

Test leads are connected to the E (C1), S (P2), and H (C2) terminals to measure wiring resistance.

---

### Two-pole measurement, low-resistance measurement (two-terminal)

---

Test leads are connected to the E (C1) and H (C2) terminals to measure wiring resistance.

---

## (6) Automatic on-display measured-value freezing capability

The instrument automatically freezes the on-display value after automatically completing a measurement. The display shows the **HOLD** symbol.

Pressing the **MEASURE** button of the instrument freezing the on-display value can switch the display to measuring mode.

## (7) Backlight

- Colors  
White, red
- Automatic backlight-off capability  
Yes (Only for the white one, the backlight is automatically turned off after 40 s  $\pm$ 5s of inactivity or after the same period following the last lighting up or flashing on and off of the live-line warning indicator)
- If the comparator gives an fail judgment, the red backlight is turned on. (When the white back light is active, the red backlight is illuminated instead.)

## (8) Continuous measurement mode

- Extending or holding the **MEASURE** button enables the instrument to measure earth resistance continuously.
- Retracting or releasing the **MEASURE** button of the instrument during continuous measurement stops the measurement.
- Continuous operating time  
When four HR6 Nickel-metal hydride batteries (1900 mAh capacity each) are used (reference value at 23°C)  
About 3.5 hours (three-pole measurement, auxiliary earth resistance of 100  $\Omega$ , measuring a resistance of 10  $\Omega$  using the 30  $\Omega$  range, without the Z3210 installed)  
About 3 hours (three-pole measurement, auxiliary earth resistance of 100  $\Omega$ , measuring a resistance of 10  $\Omega$  using the 30  $\Omega$  range, with the Z3210 installed, using wireless communications)

When four LR6 Alkaline batteries are used (reference value at 23°C)

About 3 hours (three-pole measurement, auxiliary earth resistance of 100 Ω, measuring a resistance of 10 Ω using the 30 Ω range, without the Z3210 installed)

About 2.5 hours (three-pole measurement, auxiliary earth resistance of 100 Ω, measuring a resistance of 10 Ω using the 30 Ω range, with the Z3210 installed, using wireless communications)

### (9) Blown-fuse detection

The instrument issues a warning if the circuit protection fuse for low-resistance measurement is blown.

- If the instrument with the circuit-protection fuse blown is attempted to measure low resistance, it blinks the **[FUSE]** message.
- The instrument with the blown fuse does not display any measured values of low-resistance measurements.

### (10) Manual display switching capability

Every time the **Fn** button is pressed, the display switches to the next display.









#### Two-pole measurement

Displayed content	Symbol	On-display symbol
(1) Earth-resistance value of the earth electrode	$R_E$	<b>RE</b>
(2) Ground potential	—	~ / 

#### Three-pole measurement (including the MEC function)

Displayed content	Symbol	On-display symbol
(1) Earth-resistance value	$R_E$	<b>RE</b>
(2) Earth-resistance value of Auxiliary Earth Electrodes S	$R_S$	<b>RS</b>
(3) Earth-resistance value of Auxiliary Earth Electrodes H	$R_H$	<b>RH</b>
(4) Ground potential	—	~ / 

**Four-pole measurement (including the MEC function)**

Displayed content	Symbol	On-display symbol
(1) Earth-resistance value	$R$	 (except MEC)
(2) Earth-resistance value of Auxiliary Earth Electrode E	$R_E$	
(3) Earth-resistance value of Auxiliary Earth Electrode ES	$R_{ES}$	
(4) Earth-resistance value of Auxiliary Earth Electrodes S	$R_S$	
(5) Earth-resistance value of Auxiliary Earth Electrodes H	$R_H$	
(6) Ground potential	—	 / 
(7) Ground resistivity	$\rho$	 (except MEC)

**(11) Over-ground potential indication**

Indicates that the ground potential exits the acceptable range in earth-resistance measurement.

**(12) Ongoing earth-resistance measurement indication**

During the response time, the main seven-segment display indicates the measurement states.



**(13) Beep**

At the start and end of earth-resistance measurements, the buzzer sounds.





At the start of low-resistance measurements, the buzzer sounds.

When the comparator is turned on, the buzzer sounds based on the judgment result.

**(14) Wireless communications (only with the Z3210 installed)**

<b>Operation</b>	The wireless communications can be turned on and off.
<b>Specifications</b>	Communicable distance: about 10 m (line-of-sight)
<b>Indication</b>	When the wireless communications capability is off: The  symbol disappears. When the wireless communications capability is on: The  symbol appears. During wireless communications: The  symbol blinks.

**(15) HID function switching capability (only with the Z3210 installed)**

<b>Operation</b>	The HID function of the Z3210 can be turned on and off.
<b>How to operate</b>	Turn the instrument on by rotating the rotary switch while pressing the  and  buttons. Use the  or  button to turn the HID function on or off. After pressing the <b>SET</b> button to confirm, the instrument is automatically turned off.

**(16) Updating capability**

<b>Operation</b>	The firmware of the instrument can be updated using GENNECT Cross.
<b>Requirements</b>	GENNECT Cross of version 1.8 or later

**(17) Comparator**

<b>Judgment operation</b>	<ul style="list-style-type: none"> <li>• (Earth-resistance value) <math>\leq</math> (Reference value) (Low-resistance value) <math>\leq</math> (Reference value) The <b>PASS</b> symbol appears. The buzzer sounds three times intermittently.</li> <li>• (Earth-resistance value) <math>&gt;</math> (Reference value) (Low-resistance value) <math>&gt;</math> (Reference value) The <b>FAIL</b> symbol appears. The buzzer sounds for a longer duration.</li> </ul>
<b>When the instrument is turned on</b>	The instrument can be used with the stored setting.
<b>Settable reference values</b>	1 $\Omega$ to 500 $\Omega$ or the off setting
<b>Factory-preset reference value</b>	100 $\Omega$

**(18) Display**

<b>LCD</b>	Reflective FSTN LCD, positive
<b>Backlight</b>	Yes
<b>Over-ground potential indication</b>	The <b>NOISE</b> symbol appears.
<b>Zero-adjustment effectiveness indication</b>	The <b>0<math>\Omega</math> ADJ</b> symbol appears.
<b>Auxiliary earth electrode state indication</b>	A relevant terminal symbol ( <b>E</b> , <b>ES</b> , <b>S</b> , or <b>H</b> ) blinks.
<b>Clamp state indication</b>	The  symbol blinks.
<b>Ground potential DC/AC auto-detection on/off indication</b>	The <b>AUTO</b> symbol appears when the auto-detection is enabled.

## Factory default settings and setting backup

Item	Factory default setting	Setting backup
<b>APS</b>	On	No
<b>Automatic backlight-off</b>	On	Yes
<b>Output voltage</b>	30 V (8 V for two-pole measurement)	Yes
<b>Measurement frequency</b>	128 Hz	Yes
<b>Distance</b>	10.0 m	Yes
<b>Comparator</b>	On Reference value: 100 Ω	Yes (On/off, set value)
<b>Zero adjustment</b>	No	Yes (On/off, zero-adjustment value)
<b>Wireless communications capability setting</b>	On (On first startup after the Z3210 is installed)	Yes (On/off)

## 5.4 Specifications of Optional Equipment

### FT9847 Signal Induction Clamp

<b>Application purpose</b>	Dedicated to the FT6041 Earth Tester, for injecting measurement signals
<b>Operating environment</b>	Indoor use, outdoor use, pollution degree 2, altitude up to 2000 m (6562 ft.)
<b>Operating temperature and humidity range</b>	-25°C to 65°C (-13°F to 149°F) 80% RH or less (non-condensing)
<b>Storage temperature and humidity range</b>	-25°C to 65°C (-13°F to 149°F) 80% RH or less (non-condensing)
<b>Dust resistance and water resistance</b>	Under storage condition: IP40 (EN 60529)
<b>Standards</b>	Safety: EN 61010 EMC: EN 61326
<b>Measurable conductor diameter</b>	52 mm or less in diameter Can be clamped around a busbar with a section size of 78 mm × 20 mm
<b>Dimensions</b>	Approx. 106W × 225H × 35D mm (4.2W × 8.9H × 1.4D in., excluding protruding parts and cables)
<b>Cable length</b>	2 m ±150 mm (including the banana plugs)
<b>Weight</b>	Approx 610 g (21.5 oz.)
<b>Product warranty period</b>	1 year (up to 10,000 times of closing and opening of the sensor)
<b>Accessories</b>	Operating Precautions (0990A907) Operation-check resistor (25 Ω ±1%)
<b>Rated current</b>	50 A (with a frequency between 45 Hz and 128 Hz)
<b>Maximum input current</b>	1000 A, continuously (with a frequency between 45 Hz and 128 Hz, at an ambient temperature of 65°C, for 1 min., the current value the device withstands if inputted)
<b>Maximum rated line-to-ground voltage</b>	600 V AC (measurement category III) 300 V AC (measurement category IV) Anticipated transient overvoltage: 6000 V
<b>Connector</b>	4 mm-diameter banana plug

### CT9848 Clamp on Sensor

<b>Application purpose</b>	Dedicated to the FT6041 Earth Tester, for detecting measurement signals
----------------------------	---

<b>Operating environment</b>	Indoor use, outdoor use, pollution degree 2, altitude up to 2000 m (6562 ft.)
<b>Operating temperature and humidity range</b>	-25°C to 65°C (-13°F to 149°F) 80% RH or less (non-condensing)
<b>Storage temperature and humidity range</b>	-25°C to 65°C (-13°F to 149°F) 80% RH or less (non-condensing)
<b>Dust resistance and water resistance</b>	Under storage condition: IP40 (EN 60529)
<b>Standards</b>	Safety: EN 61010 EMC: EN 61326
<b>Measurable conductor diameter</b>	52 mm or less in diameter Can be clamped around a bus-bar with a section size of 78 mm × 20 mm
<b>Dimensions</b>	Approx. 106W × 225H × 35D mm (4.2W × 8.9H × 1.4D in., excluding protruding parts and cables)
<b>Cable length</b>	2 m ±150 mm (including the output connector)
<b>Weight</b>	Approx 620 g (21.9 oz.)
<b>Product warranty period</b>	1 year (up to 10,000 times of closing and opening of the sensor)
<b>Accessories</b>	Operating Precautions (0990A907)
<b>Rated primary current</b>	100 AAC
<b>Rated secondary current</b>	100 mAAC
<b>Maximum input current</b>	1000 A (with a frequency between 45 Hz and 128 Hz, at an ambient temperature of 65°C, for 1 min.)
<b>Maximum rated line-to-ground voltage</b>	600 V AC (measurement category III) 300 V AC (measurement category IV) Anticipated transient overvoltage: 6000 V
<b>Output connector</b>	Water-proof connector for exclusive use on the FT6041
<b>Accuracy guarantee conditions</b>	Accuracy guarantee duration: 1 year Number of times the sensor can be opened/closed: Up to 10,000 times Accuracy guarantee temperature and humidity range: 23°C ±5°C (73°F ±9°F), 80% RH or less Measurement conditions: With an input frequency between 45 Hz and 128 Hz, conductor located at the center of the core
<b>Amplitude accuracy</b>	±1.0% rdg ±0.05% f.s. (See the FT6041 specifications for combinational accuracy.)
<b>Amplitude-frequency characteristics</b>	Within ±2% (with an input frequency between 40 Hz and 128 Hz, deviation from accuracy)
<b>Phase accuracy</b>	Within ±1% (with an input frequency between 45 Hz and 128 Hz)

## 6.1 Repair, Inspection, and Cleaning

 **WARNING**

- **Do not attempt to modify, disassemble, or repair the instrument.**

Doing so may cause bodily injury or fire.

 **CAUTION**

Observe the following when shipping the instrument.



- **Remove the batteries, accessories, and optional equipment from the instrument.**
- **Include a description of the malfunction.**
- **Use the packaging in which the instrument was initially delivered and then pack that in an additional box.**

Failure to do so could cause damage during shipment.

**Calibrations**

The appropriate schedule for calibration depends on factors such as the operating conditions and environment. Determine the appropriate calibration interval based on your operating conditions and environment and have Hioki calibrate the instrument accordingly.

**Backing up your data**

When repairing or calibrating the instrument, Hioki may reset it (factory reset). It is recommended to back up (save/write) data such as the settings and measurement data before requesting service.

## If the instrument is not to be used for an extended period

### CAUTION

- **Remove the batteries from the instrument when it will not be used for an extended period.**



Failure to do so could cause the batteries to leak, damaging the instrument.

---

## Cleaning

---

### CAUTION

- **If the instrument becomes dirty, wipe it clean with a soft cloth moistened with water or a neutral detergent.**



Solvents such as benzene, alcohol, acetone, ether, ketone, thinners, or gasoline could deform or discolor the instrument.

---

Wipe the display gently with a soft, dry cloth.

## Limited-life parts and consumables

---

The instrument, included accessories, and optional equipment include limited-life parts and consumables. They will deteriorate differently depending on the frequency of use, elapsed time, and operating environment of the product. To keep using the instrument in a condition that satisfies its specifications, Hioki recommends replacing them periodically.

To replace optional equipment, please contact your authorized Hioki distributor or reseller.

Hioki will retain parts of this model for five years after its completion of production.

### Limited-life parts

Limited-life parts are not user-replaceable.

Replacement of these parts may cost even during the product warranty period for the product. The recommended replacement cycle does not guarantee regular operation within the product warranty period.

### Fuse set

The fuse set (Z5052, containing two pieces) can be purchased from your authorized Hioki distributor or reseller.

### Protector

The protector is available as a service part. Contact your authorized Hioki distributor or reseller.

## Disposing of the instrument

---

Dispose of the instrument by local regulations.

## 6.2 Troubleshooting

If damage is suspected, read the “Before returning the instrument for repair” (p. 120) section before contacting your authorized Hioki distributor or reseller. If this does not help you, contact your authorized Hioki distributor or reseller.

### Before returning the instrument for repair

If the instrument is not operating correctly, check the following items:

**(1) The instrument cannot be turned on.**

- There are no batteries inside.
- The batteries have been incorrectly inserted.
- The batteries have been depleted.

Replace the batteries with fresh ones. If the instrument, even with fresh batteries inserted, still cannot be turned on, the instrument has a failure and needs to be repaired.

See “2.2 Inserting/Replacing Batteries” (p.32).

**(2) The instrument is unintentionally turned off during a measurement.**

- The batteries to be used may have been left for a long time.  
Battery voltages may recover over time. The voltage can seem high enough to work; however, such batteries, which provide only a little energy, cannot work. Replace the batteries with new ones.
- The batteries with high internal resistance are used.  
Such high-internal-resistance batteries, which provide only a little energy even if they are fresh, cannot work. Use batteries produced by other manufactures.
- The instrument is used in a low temperature (below the freezing point).  
The batteries' internal resistance increases at low temperatures; thus, the instrument may be turned off during a measurement. Use lithium batteries or warm the batteries before measurements.

**(3) The resistance of auxiliary earth electrodes does not come down (precision measurement).**

- Connection of the measurement cables is poor. The ground is dry.

Make sure that the measurement cables are connected to the earth electrodes or the auxiliary earthing rods. Short-circuit the tips of the measurement cables before measurements.

If the measured value is approx.  $0\Omega$ , it results from a high earth-resistance of the earth electrodes. Drive the auxiliary earthing rods more deeply. Alternatively, pour water over the auxiliary earthing rods. If the resistance still does not come down, move the auxiliary earth electrodes to other locations.

Position the yellow and red measurement cables about 100 mm away from each other.

**(4) When the [NOISE] symbol appears The ground potential is high, causing the instrument to be impossible to measure earth resistance.**

- The ground potential exceeds the acceptable value of the instrument. A large leakage current may flow into the earth electrodes from equipment connected to them. Otherwise, the earth-resistance value of the earth electrodes may be high, which results in a large ground potential caused by a small leakage current. Remove the equipment connected to the earth electrodes before measurements. See “3.13 When the [NOISE] Symbol Appears” (p. 74).

**(5) The instrument cannot make the simplified measurement (two-pole measurement) on a new home.**

- The electric utility power has not distributed yet.

**(6) An existing auxiliary earth electrode is used for measurement. The instrument displays approx.  $0\Omega$  as the measured value.**

- The earth electrodes and the auxiliary electrodes for measurement may have been connected through concrete.

Drive auxiliary earthing rods into the ground before measurements instead of using the auxiliary electrodes for measurement.

**(7) The instrument generates a slight noise inside during measurement.**

The oscillator circuit inside the instrument generates the noise. This is not a failure.

**(8) The measured value is high.**

- The two-pole measurement has been set.  
Set the rotary switch to the 3POLE position to select the three-pole measurement.

**(9) The earth nets or earth nets module was laid on asphalt to make measurements; however, the instrument cannot make earth-resistance measurements, blinking terminal symbols.**

- Since asphalt is an insulator, measurements are not possible with an earth net.

**(10) An auxiliary earthing rod has been bent.**

It is recommended to purchase the L9840 Auxiliary Earthing Rod. (Commercially available pegs have sharp tips, which may damage the carrying cases.)

## 6.3 Messages

The instrument displaying an error on the LCD needs to be repaired. Contact your authorized Hioki distributor or reseller.

Message	Description	Solution
[Err] [0ΩADJ]	The measured value falls outside the acceptable zero-adjustment range during the zero adjustment. The zero adjustment was executed while the on-screen measured value has not frozen.	Execute a zero adjustment again following the zero adjustment procedure. See “4.2 Zero-Adjustment Capability” (p.82).
[Err1]	The firmware has anomaly.	The instrument has a failure. Contact your authorized Hioki distributor or reseller to ask for repair.
[Err2]	Adjustment data is corrupted.	
[Err4]	Settings data is corrupted.	
[Err5]	The measuring circuit has anomaly.	
[Err8]	The Z3210 fails to have communications (connection failure; Z3210 or hardware failure).	Take the following actions: <ul style="list-style-type: none"> <li>• Reinsert the Z3210.</li> <li>• Insert another Z3210.</li> </ul> See “2.3 Connecting the Z3210 Wireless Adapter” (p.35).  If the error persists, the instrument has a failure. Contact your authorized Hioki distributor or reseller to ask for repair.
[Err9]	GENNECT Cross failed to update the instrument.	Use GENNECT Cross to update the instrument again.
[FUSE]	The protection fuse (replaceable) was blown.	Replace the fuse with a Hioki-specified one.
[APS] →[P.oFF]	The auto-power-saving capability will put the instrument into auto-power saving mode soon.	Turn the instrument off, then on.
[bAtt] →[P.oFF]	Decreased battery voltage will put the instrument into auto-power saving mode	Change the batteries. See “2.2 Inserting/Replacing Batteries” (p.32).
[v.UP]	GENNECT Cross is updating the instrument.	Do not operate the instrument until the update is completed.

## 6.4 Replacing the Fuse

Replace a blown fuse with a new one. The fuse set (Z5052, containing two pieces) can be purchased from your authorized Hioki distributor or reseller.

### WARNING

- **Use only fuses of the designated type, characteristics, rated current, and voltage.**

Specified fuse: FF 0.5 AH, 1000 V, ultra rapid,  $\phi 6.3 \times 32$  mm

SIBA

Do not use any other fuse (particularly one with a higher-rated current).

Do not use the instrument with the fuse holder's terminals shorted.



- **Remove the measurement cables from the object under measurement and turn the rotary switch to turn the instrument off before removing the battery compartment cover.**

Failure to do so could cause the user to experience an electric shock.

When the test leads are connected to an object under measurement, the battery fittings are considered to carry a high voltage.

- **After replacing the batteries, attach the battery compartment cover and lock the fixing knobs before using the instrument.**



Using the instrument with the battery compartment cover removed may lead to bodily injury. In addition, the cover will not be secured unless the fixing knobs of the battery compartment cover are locked.

 **CAUTION**

- **Do not subject the fuse holder to excessive force when removing the fuse.**

Otherwise, the fuse holder could be deformed, resulting in contact failure, and current measurement may not be possible.



- **Do not allow foreign matter to enter the fuse holder when replacing the fuse.**

Doing so could damage the instrument.

- **Do not use the tip of a test lead to remove the fuse.**

Doing so could bend the tip of the test lead.

**You will need:**

- Phillips-head screwdriver (No. 2), flat-blade screwdriver, or coin
- Hioki-specified fuse

**1** Disconnect the measurement cables from the instrument.

**2** Turn the rotary switch to turn the instrument off.

**3** Unlock the battery compartment cover.

Turn the two fixing knobs counterclockwise 180° with a screwdriver or a coin to align the letters **UNLOCKED** with the triangle marks (▲).

**4** Remove the battery compartment cover.

The battery compartment is sealed with the gasket. Remove one side of the battery compartment cover first, then remove the other for easy removal.

Do not remove the gasket from the battery compartment cover. (p.28)

**5** Insert a flat-blade screwdriver to remove the fuse.

**6** Fit a new fuse (the fuse has no polarity).

**7** Reattach the battery compartment cover.

**8 Lock the battery compartment cover.**

Turn the two fixing knobs clockwise 180° with a screwdriver or a coin to align the letters **LOCKED** with the triangle marks (▲).

If not attached correctly, the cover cannot maintain the dust resistance and water resistance capabilities.

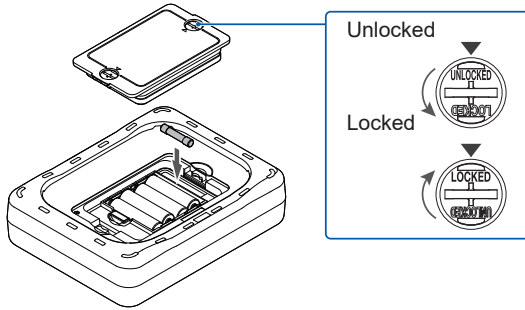

## 7.1 Earth Resistance

The resistance between an earth electrode and the ground is usually called earth resistance. To be exact, it is the sum of the resistance of a grounding conductor, the contact resistance between a grounding conductor and the ground, and the resistance of the ground.

Earth resistance, different from commonly known resistors, has the following unique characteristics.

### Polarizing action

If DC flows through the ground, which has a polarizing action like electrolytes, an electromotive force occurs in the opposite direction to the current, interfering with correct measurements. Thus, the earth-resistance measurement generally uses a rectangular wave or sine wave of several tens hertz to one kilohertz.

### Special configuration

Earth resistance is resistance between an earth electrode and the ground. It is impossible to take it out of the ground to measure it.

Since the ground has relatively high resistivity, a voltage drops near the electrode through which the current to be measured flows. Thus, Electrodes E, S (P), and H (C) need to be kept about 10 m away from each other to measure the resistance of the earth electrodes accurately.

### Presence of disturbance factors

Some factors, such as effects from ground potential and auxiliary earth electrodes, disturb the earth-resistance measurement.

The ground potential caused by a leakage current from a device connected to earth electrodes affects measured values because it is superimposed over the signal an earth tester detects. In addition, high earth resistances of auxiliary earth electrodes reduce the measurement current, making the instrument susceptible to noise, such as the ground potential.

The instrument employs a system less susceptible to these disturbances, allowing accurate measurement under adverse conditions.

## 7.2 Measurement Principle

### Measurement of earth resistance

The instrument applies a voltage from its AC voltage source between Electrodes H (C) and E to measure the flowing alternating current  $I$  with its ammeter (or a clamp sensor for the MEC function). Using its AC voltmeter, the instrument measures the voltage  $V$  generated by the flow of current  $I$  between the following electrodes:

- For the three-pole measurement, between Electrodes S (P2) and E (C1)
- For the four-pole measurement, between Electrodes S (P2) and E (C1)

The earth resistance of the Electrode E,  $R_x$  is calculated from the measured current  $I$  and voltage  $V$ .

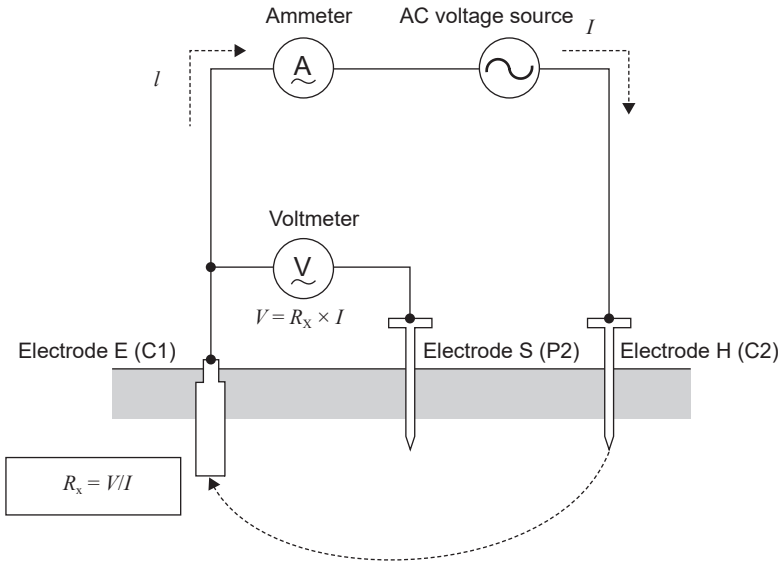

## Two-clamp measurement

### Measuring Principle

The instrument can measure the earth resistance of a specific earthing point in multiple earthing as illustrated below.

Let the earth resistance of the specific point be  $R_x$ , and the earth-resistance values of other earthing points be  $R_1, R_2, \dots, R_n$ . The resistance value measured by the instrument  $R_m$  is calculated from the following equations:

$$R_m = R_x + \frac{1}{\sum_{i=1}^n \frac{1}{R_i}}$$

If the number of the earthing points  $n$  is sufficiently large and each earth-resistance value  $R_i$  is sufficiently small, the following inequality holds.

$$R_x \gg \frac{1}{\sum_{i=1}^n \frac{1}{R_i}}$$

The second term in the equation can be ignored, allowing the instrument to measure the value of  $R_x$ .

### Low-resistance measurement

The instrument flows a current  $I$  through the object under measurement and measures the voltage generated between the measurement terminals  $V$  to obtain the resistance of the object  $R_x$ , which is calculated by dividing the inter-terminal voltage  $V$  by applied current  $I$ .

## 7.3 Tips on the Three-pole Measurement

### Distance between earth electrodes

Let  $l$  m be the distance between Electrodes E and H (C), as Fig. (a) shows. If measuring the resistance of Earth Element E while changing the distance  $x$  m between Electrodes E and S(P), you can obtain the measurement result as shown in Fig. (b). Thus, the closer Auxiliary Earthing Rod S (P) is to Earth Element E or Auxiliary Earthing Rod H (C), the more the error increases.

In addition, the shorter distance between Electrodes E and H (C) cannot separate the earth resistance under measurement ( $R_x$ ) and the earth resistance of the auxiliary earthing rod ( $R_c$ ), resulting in a more significant measurement error. If earthing has been provided using a large area, such as a building structure, the resistance area of the earth resistance ( $R_x$ ) indicated in Fig (a) becomes wider.

To make accurate measurement, Auxiliary Earthing Rods S (P) and H (C) need to be driven far enough away from the earth element E.

Use the following procedure to check if the auxiliary earthing rods are placed appropriately.

1. Measure earth resistance at several positions while moving Auxiliary Earthing Rod S (P) from near Earth Element E toward Auxiliary Earthing Rod H (C).
2. As shown in Fig. (b), check if a horizontal part where the measured resistance values are almost constant is found.

If no horizontal part is found, which occurs because the measurement distance is insufficient, drive Auxiliary Earthing Rods S (P) and H (C) far away.

Fig. (a)

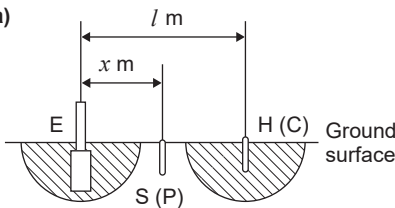

Resistance area of the earth resistance under measurement ( $R_x$ )

Resistance area of Auxiliary Earthing Rod H (C) and earth resistance ( $R_c$ )

Fig. (b)

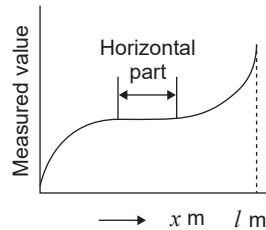

Electrodes E and H (C) can be separated up to 50 m by using the optional L9843-51, L9843-52, or L9843-53. Electrode S (P) can also be separated from Electrode E within the distance where the horizontal part is found shown in Fig. (b). Measurements can be made, in principle, even if they are separated more than 50 m; however, the measurement results cannot be guaranteed.

## Locations to drive the auxiliary earthing rods

It is ideal to drive Auxiliary Earthing Rod S (P) at the middle point of the line segment connecting Earth Element E and Auxiliary Earthing Rod H (C).

If Auxiliary Earthing Rod S (P) can not be driven on the line segment connecting Earth Element E and Electrode H (C) because of some reason, such as an obstacle, measurement errors can be reduced by driving it at a location that satisfies both of the following two conditions:

- Auxiliary Earthing Rod S (P) is separated 5 m or more from both Earth Element E and Auxiliary Earthing Rod H (C).
- The angle at which the lines connecting Points E and H (C) and Points E and S (P) meet is  $29^\circ$  or less.

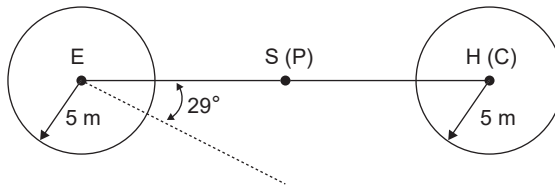

## How to insert the auxiliary earthing rods

---

The included auxiliary earthing rods are suitable for providing auxiliary earth electrodes; their thickness and hardness are designed for insertion into the ground with general hardness by hand. It can be inserted into a small gap because it is thinner than those of previous models.

Wear gloves and insert them perpendicular to the ground surface.

If the ground is too hard to insert them by hand, use a hammer to drive them into the ground perpendicularly. Hammering an auxiliary earthing rod too hard may result in bending it. If it cannot be driven into the ground with gentle taps, use the optional 9050 Earth Nets for measurement.

# Index

## A

- Auto-power saving mode..... 86
- Auxiliary Earthing Rod..... 79

## C

- Carrying Case..... 31
- Comparator capability..... 84
- Continuous measurement capability .... 55, 81
- Current-direction mark..... 29, 56

## E

- Earth Net Module..... 37
- Earth Nets..... 52
- Earth resistance
  - Four-pole measurement ..... 60
  - MEC..... 60
  - Three-pole measurement ..... 51, 55
  - Two-clamp ..... 62
  - Two-pole measurement ..... 64
- Error..... 123
- Excel direct input function..... 89

## F

- Firmware version number..... 92
- Fuse..... 124

## G

- GENNECT Cross..... 87
- Ground resistivity
  - Four-pole measurement ..... 57

## H

- HID function..... 89

## L

- Low resistance
  - Four-pole measurement ..... 71
  - Two-pole measurement ..... 68

## M

- Measurement function..... 49
- Measurement principle ..... 128
- MEC..... 55

- Message..... 123

## N

- Nickel-metal hydride battery ..... 20, 33

## O

- Operation-check resistor ..... 48

## P

- Power-saving capability..... 86

## S

- Serial number ..... 28, 29, 91
- Simplified measurement..... 64

## T

- Terminal symbol..... 76

## W

- Winder ..... 37
- Wireless Adapter ..... 35, 87
- Wireless communications function ..... 87

## Z

- Z3210 ..... 35, 87
- Zero adjustment capability..... 82



# Warranty Certificate

# HIOKI

Model	Serial number	Warranty period Three (3) years from date of purchase ( ___ / ___ )
-------	---------------	--

Customer name: \_\_\_\_\_

Customer address: \_\_\_\_\_

## Important

- Please retain this warranty certificate. Duplicates cannot be reissued.
- Complete the certificate with the model number, serial number, and date of purchase, along with your name and address. The personal information you provide on this form will only be used to provide repair service and information about Hioki products and services.

This document certifies that the product has been inspected and verified to conform to Hioki's standards. Please contact the place of purchase in the event of a malfunction and provide this document, in which case Hioki will repair or replace the product subject to the warranty terms described below.

## Warranty terms

1. The product is guaranteed to operate properly during the warranty period (three [3] years from the date of purchase). If the date of purchase is unknown, the warranty period is defined as three (3) years from the date (month and year) of manufacture (as indicated by the first four digits of the serial number in YYMM format).
2. If the product came with an AC adapter, the adapter is warranted for one (1) year from the date of purchase.
3. The accuracy of measured values and other data generated by the product is guaranteed as described in the product specifications.
4. In the event that the product or AC adapter malfunctions during its respective warranty period due to a defect of workmanship or materials, Hioki will repair or replace the product or AC adapter free of charge.
5. The following malfunctions and issues are not covered by the warranty and as such are not subject to free repair or replacement:
  - 1. Malfunctions or damage of consumables, parts with a defined service life, etc.
  - 2. Malfunctions or damage of connectors, cables, etc.
  - 3. Malfunctions or damage caused by shipment, dropping, relocation, etc., after purchase of the product
  - 4. Malfunctions or damage caused by inappropriate handling that violates information found in the instruction manual or on precautionary labeling on the product itself
  - 5. Malfunctions or damage caused by a failure to perform maintenance or inspections as required by law or recommended in the instruction manual
  - 6. Malfunctions or damage caused by fire, storms or flooding, earthquakes, lightning, power anomalies (involving voltage, frequency, etc.), war or unrest, contamination with radiation, or other acts of God
  - 7. Damage that is limited to the product's appearance (cosmetic blemishes, deformation of enclosure shape, fading of color, etc.)
  - 8. Other malfunctions or damage for which Hioki is not responsible
  - 9. After disassembly, such as opening the product, has been performed by the customer without permission by Hioki
6. The warranty will be considered invalidated in the following circumstances, in which case Hioki will be unable to perform service such as repair or calibration:
  - 1. If the product has been repaired or modified by a company, entity, or individual other than Hioki
  - 2. If the product has been embedded in another piece of equipment for use in a special application (aerospace, nuclear power, medical use, vehicle control, etc.) without Hioki's having received prior notice
7. If you experience a loss caused by use of the product and Hioki determines that it is responsible for the underlying issue, Hioki will provide compensation in an amount not to exceed the purchase price, with the following exceptions:
  - 1. Secondary damage arising from damage to a measured device or component that was caused by use of the product
  - 2. Damage arising from measurement results provided by the product
  - 3. Damage to a device other than the product that was sustained when connecting the device to the product (including via network connections)
8. Hioki reserves the right to decline to perform repair, calibration, or other service for products for which a certain amount of time has passed since their manufacture, products whose parts have been discontinued, and products that cannot be repaired due to unforeseen circumstances.

HIOKI E. E. CORPORATION

25-10 EN-3



# HIOKI

[www.hioki.com/](http://www.hioki.com/)



**All regional  
contact  
information**

**HIOKI E.E. CORPORATION**

81 Koizumi, Ueda, Nagano 386-1192 Japan

2402 EN

---

Edited and published by HIOKI E.E. CORPORATION

Printed in Japan

- Contents subject to change without notice.
- This document contains copyrighted content.
- It is prohibited to copy, reproduce, or modify the content of this document without permission.
- Company names, product names, etc. mentioned in this document are trademarks or registered trademarks of their respective companies.

**Europe only**

- EU declaration of conformity can be downloaded from our website.
- Contact in Europe: HIOKI EUROPE GmbH  
Helfmann-Park 2, 65760 Eschborn, Germany [hioki@hioki.eu](mailto:hioki@hioki.eu)