

HIOKI

Measuring Instruments for the Battery Industry

Production Processes Research Development

Introducing HIOKI's line of measuring instruments for the battery industry

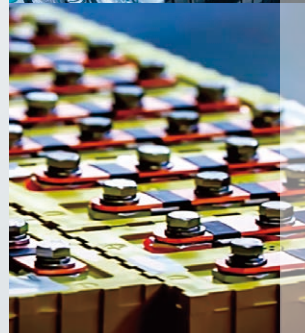

Supporting the batteries of today

Leading the way to the batteries of tomorrow

Hioki contributes to the manufacture and development of batteries with comprehensive and robust measurement solutions.

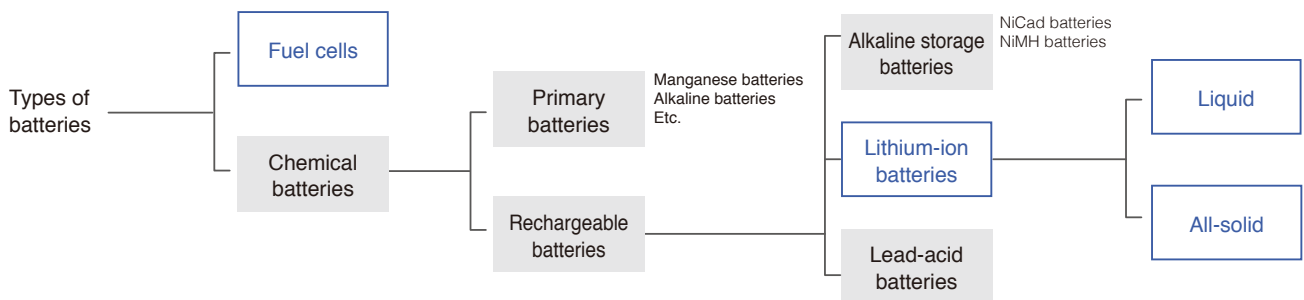

Commercialization of lithium-ion batteries is proceeding across the board as manufacturers bring to market products ranging from compact to large-scale models.

Lithium-ion batteries (LIBs), a type of rechargeable battery notable for their extremely high level of performance, have been used primarily in off-the-shelf products such as notebook computers and mobile phones. Over the past few years, manufacturers have been working with automakers and other companies to optimize the LIBs used in electric and plug-in hybrid vehicles with large variants that offer an even higher level of performance and technology in the form of enhanced safety, higher output, and longer service life. Efforts are also underway to bring LIBs to fixed installations and industrial applications, including use in storage systems in residential and commercial settings (for example in buildings, shops, and manufacturing plants), in industrial machinery such as forklifts, and as emergency power supplies for facilities such as mobile phone base stations.

Lithium-ion and next-generation batteries

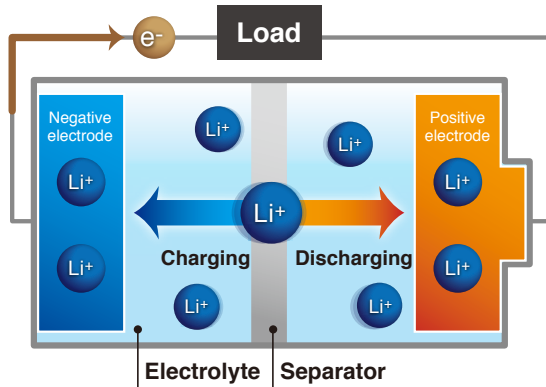

Lithium-ion batteries (liquid)

Lithium-ion batteries, a type of rechargeable battery in which charging and discharging is accomplished by the movement of lithium ions between positive and negative electrodes, are expected to see broad use in applications ranging from off-the-shelf commercial goods to vehicles due to their low weight and high capacity. As part of the global effort to wean society off carbon-based sources of energy, research is expanding to boost capacity and extend service life for use in electric vehicles.

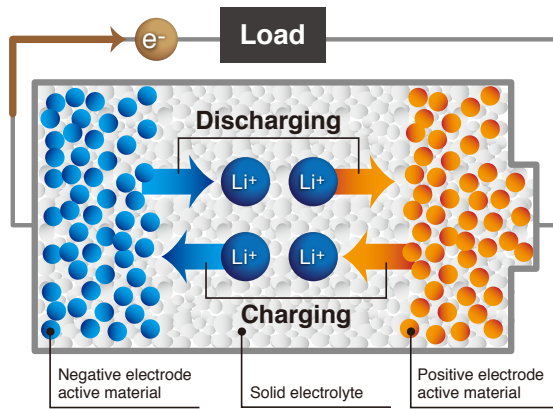

All-solid lithium-ion batteries

All-solid batteries would offer a higher level of safety since they do not use flammable electrolyte. Research is underway to develop such batteries for use in vehicles since they can be charged in several minutes.

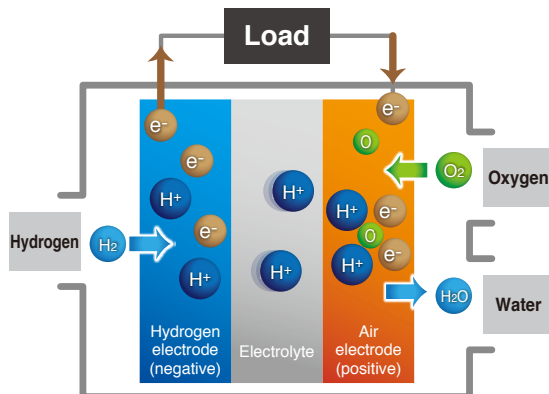

Fuel cells

Fuel cells are like generators that use a substance such as hydrogen as fuel. Fuel cell-powered vehicles offer a high level of convenience compared to electric vehicles thanks to their long range and fast fill-up times. Fuel cells are a well-established technology that has already been used in applications such as forklifts and residential cogeneration systems.

Next-generation battery technologies
(*Research by Hioki)

Volumetric energy density (Wh/L)

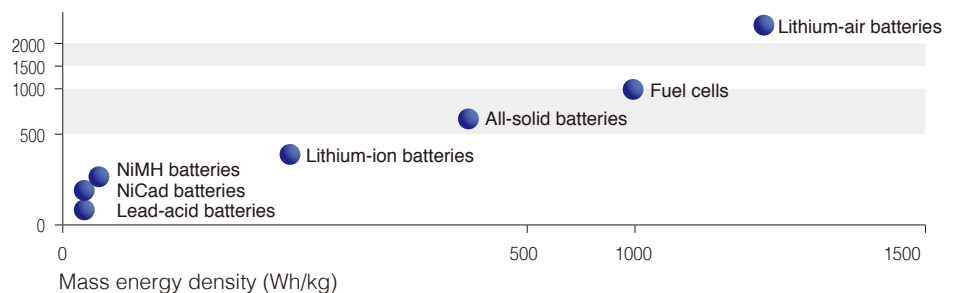

Solutions for Lithium-ion Battery Production Processes

LIB research and development as quality control of electrode sheets continues to evolve



Electrode Resistance Measurement System RM2610

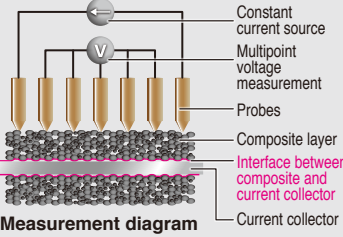

Constant current source
Multipoint voltage measurement
Probes
Composite layer
Interface between composite and current collector
Current collector

Measurement diagram

Measure the potential at the electrode sheet surface and use a proprietary Hioki analytical technique to isolate the composite layer resistance and the resistance at the interface between the composite and the current collector. Output this value to quantify the interface resistance, a quantity that has not been possible to ascertain in the past.

Detecting contamination, separator damage, and short-circuits between the negative electrode and enclosure



Insulation Tester ST5520 (left)
Super Megohmmeter SM7110 (right)



DC Voltmeter DM7276

Before electrolyte filling
Apply a voltage to the device under test and measure the insulation resistance.
Detect metal contaminants and separator damage by measuring insulation resistance. Incomplete isolation of electrodes can result in fire.

After electrolyte filling
Measure voltage with a DC voltmeter. Applying a voltage after the battery has been filled with electrolyte can cause damage.
Detect short-circuits between the negative electrode and the enclosure by measuring the DC voltage between the positive electrode and the enclosure, thereby preventing a reduction in the battery's service life.

Contact check function: Incomplete contact between the measurement probes and the device under test could result in an erroneous non-defective judgment. A contact check function is indispensable for keeping defective products from being passed on to the next production process or shipped.

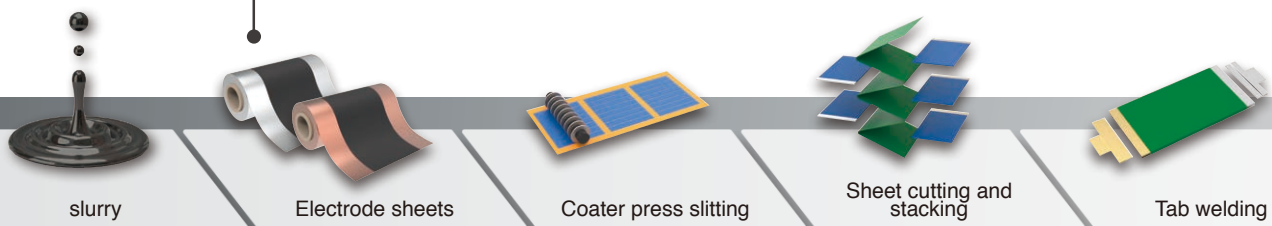

Multichannel measurement



Switch Mainframe SW1001 (3 slots)
Switch Mainframe SW1002 (12 slots)

Add units to accommodate connected instruments.

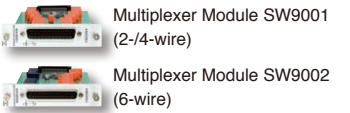

Multiplexer Module SW9001 (2-/4-wire)
Multiplexer Module SW9002 (6-wire)

Interfaces

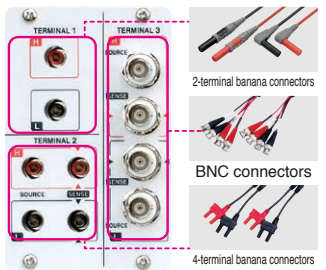

2-terminal banana connectors
BNC connectors
4-terminal banana connectors

No-load voltage measurement



DC Voltmeter DM7276

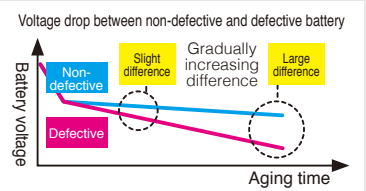

Voltage drop between non-defective and defective battery

Non-defective Slight difference Gradually increasing difference Large difference
Defective

Battery voltage vs Aging time

Discover initial defects by checking for a voltage drop during aging testing. When a battery has a defect such as a minute short-circuit, self-discharging causes the battery voltage to fall. However, it takes time for a large voltage drop to develop due to the minuscule magnitude of the discharge. Defects can be discovered with short aging times if a high-precision, high-resolution voltmeter is used so that slight voltage drops can be detected.

Verifying the quality of cell junctions and busbars



Resistance Meter RM3545-02



Verify weld quality by measuring the resistance at cell junctions and busbars. Defective welds cause increased resistance at the connection, resulting in greater heat loss during charging and recharging.

The RM3545-02, which has a built-in multiplexer, can perform 4-terminal resistance measurement at up to 20 locations.

Example of connected instrument ▶



Connect the **DM7276**
Up to 264 channels
(2-terminal measurement: 22 channels)

Using the Multiplexer Module SW9001

Simultaneously testing temperature and voltage



Wireless Logging Station LR8410



Continuously monitor up to 105 channels. Simultaneously measure temperature, heat flows, and cell terminal voltage.

Accurately assess the relationship between battery characteristics, temperature, and heating by simultaneously measuring temperature, heat flows, and voltage at multiple points. Simultaneous, multipoint measurement capability is a must since high module voltages mean more cells to test.

Evaluate batteries during aging and actual operation.

Test charge and discharge



Power Analyzer PW6001

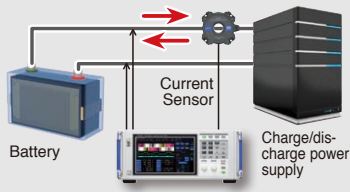

Accurately identify capacity (Ah, Wh), charge/discharge curves, and charge/discharge energy efficiency and loss by simultaneously measuring voltage and current during charge cycles. Integrate into a system linked to a charge/discharge power supply.

Evaluate high-voltage, high-current setups with the instrument's 1500 V/2000 A range.

Evaluate and test BMS



Battery Cell Voltage Generator SS7081-50

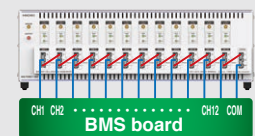

12 channel connection example

Simulate open wires and shorts in a battery of up to 1000 V with channels connected in series.

High-accuracy signal generation and measurement capabilities are useful when evaluating BMS performance. In addition, the ability to verify performance under abnormal conditions is useful when evaluating safety.

Built-in high-accuracy output circuitry and voltage monitoring circuitry support high-precision BMS ICs.

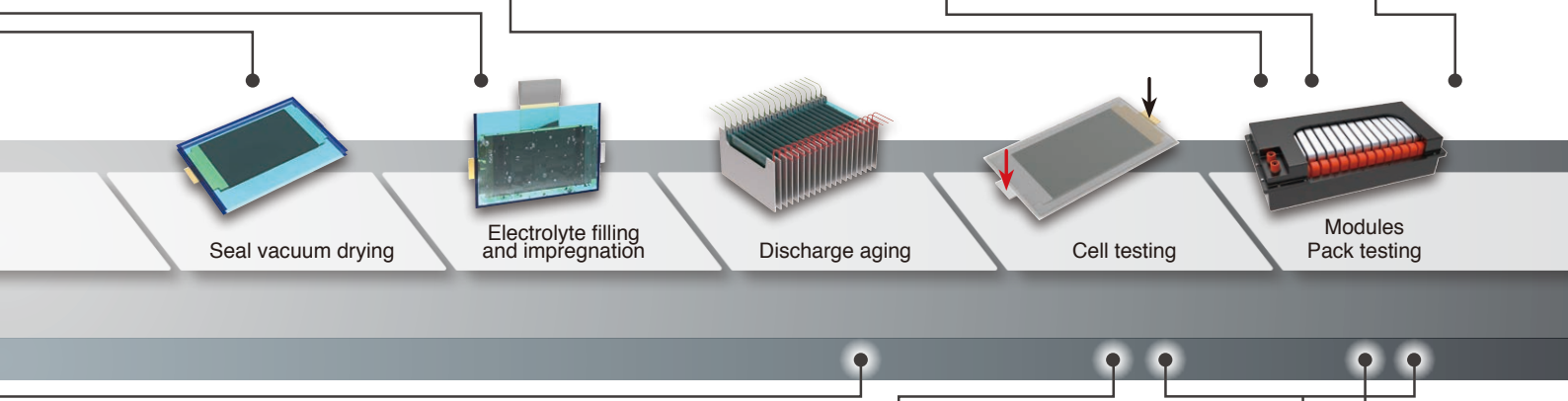

Discovering and analyzing the causes of cell defects

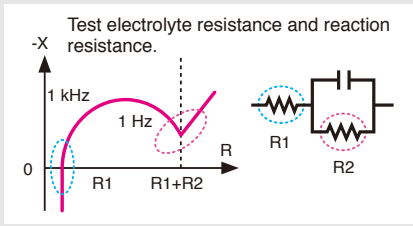

Battery Impedance Meter BT4560 / Chemical Impedance Analyzer IM3590

Test electrolyte resistance and reaction resistance.

Identify the causes of battery cell defects by measuring AC impedance at multiple frequencies. For example, you can identify batteries that have issues with electrode reactions at the electrode interface by checking impedance at low frequencies. You can also extend this approach to cover multiple channels by combining the instrument with a switching system.

Measuring internal resistance and no-load voltage



Battery HiTester BT3562A, BT3563A, BT3564

Batteries exhibit electromotive force (EMF).

With EMF...
 Measuring internal resistance with a DC resistance meter: No
 Measuring internal resistance with an AC resistance meter: Yes

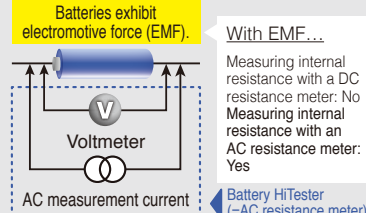

AC measurement current

Measure internal resistance and the battery's no-load voltage at the same time. Since measurement can be carried out quickly, this approach is well suited to shipping inspections and acceptance inspections of cells and battery packs.



Connect the **BT4560/IM3590**
Up to 72 channels
 (4-terminal pair measurement: 6 channels)
 Using the Multiplexer Module SW9002



Connect the **BT3562A or BT3563A/BT3564**
Up to 132 channels
 (4-terminal measurement: 11 channels)
 Using the Multiplexer Module SW9001

Solutions for Research & Development

Measuring the internal resistance of fuel cells Special edition specifications

Assess fuel cell characteristics in real time while under load.

BT3563-01/BT3564 with special edition specifications

The BT3563-01/BT3564 with special edition specifications features increased noise resistance to reduce the effects of noise from load devices. The instrument can ascertain fuel cell state based on impedance measured at a frequency of 1 kHz.

Max. input voltage
 ±300 V DC (BT3563-01)
 ±1000 V DC (BT3564)

Detecting battery pack wire breaks Special edition specifications

Detect wire breaks in battery packs with sweep measurement starting at a low frequency.

BT4560 custom
 measurable voltage 20 V *Battery packs with protective circuits cannot be tested.

1 kHz (high frequency)
 Detection of defects is difficult due to the small difference in impedance values exhibited by non-defective and defective products.

Sweep from 0.1 Hz (low frequency)
 Detection of wire breaks is simple since it is possible to compare points exhibiting large differences.

Evaluating charging and discharging in finished vehicles

Power Analyzer PW6001

Clamp-type AC/DC current probes

- High accuracy: ±0.3% rdg.
- Operating temperature range: -40°C to 85°C
- 20 A to 1000 A

Measure power in up to six circuits with a single instrument.

Supports multiple charge/discharge tests including for auxiliary batteries

Accurately measure charge capacity and discharge magnitude by accurately capturing voltage and current values at 5 MHz sampling speeds as they change from moment to moment in the battery under conditions of actual operation while a finished vehicle is driven (in WLTP mode, etc.).

Measuring the volume resistivity of composites

Resistance Meter RM3545

4-point probes (5.0 mm pitch) **RM9010-01**

4-point probes (1.5 mm pitch) **RM9010-02**

For measuring volume resistivity, surface resistivity, and conductivity

Other Solutions

264-channel logger for multichannel battery evaluation and multipoint Cole-Cole plot generation: SW1001/SW1002

Multipoint Cole-Cole plots when used in combination with the BT4560



High-precision 264-channel logger with 7.5 digits of accuracy when used in combination with the DM7276



Example battery test setup: SW1001 + BT3562A + DM7276

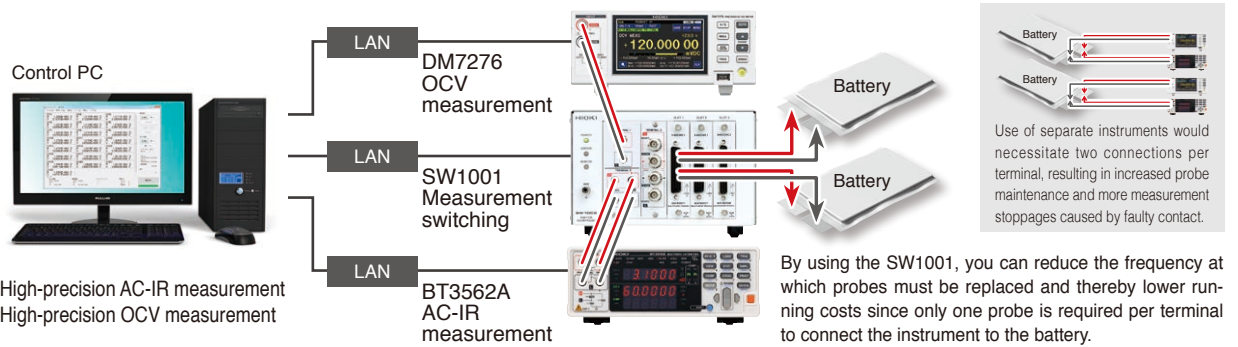

Maximum input of 1000 V for testing high-voltage battery packs used in EVs and PHEVs: BT3564

Safely and easily measure high-voltage battery packs with Pin Type Lead L2110 that can handle up to 1000 V and BT3564.

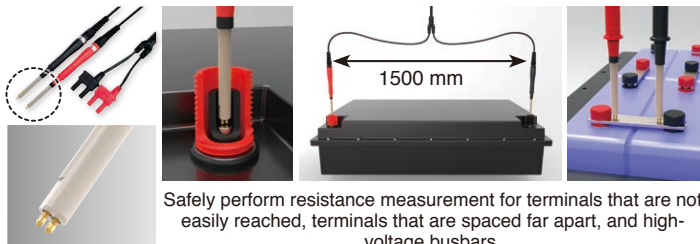

Pin Type Lead L2110 (selling separately): Tip length of 50 mm and diameter of 7 mm

Monitor total resistance using analog output functionality.

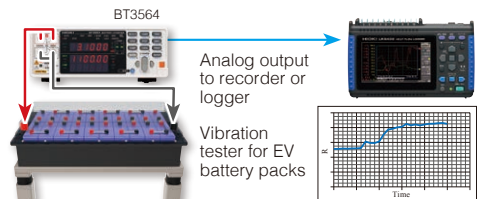

- Record fluctuations in total resistance during vibration testing.
- Use in conjunction with a recorder or logger to simultaneously record temperature.

Portable model that's ideal for diagnosing degradation of lead-acid batteries in the field: BT3554-50

Make reliable measurements while a UPS is operating thanks to improved noise resistance and save the results in as little as 2 seconds.

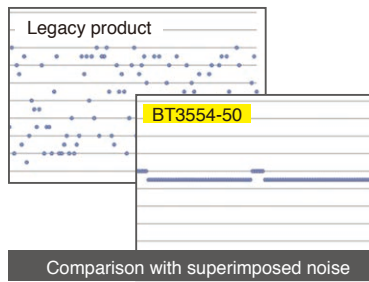
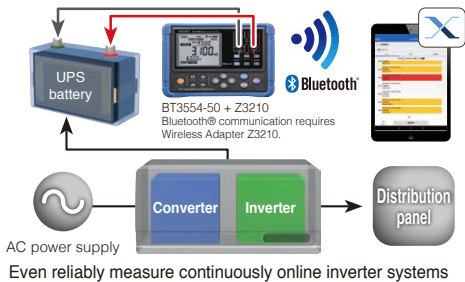

New L-shaped probes make it easy to measure deep inside a UPS.

Product specifications *For more detailed specifications, please see the catalog for the product in question.



- Production-line testing of high-voltage battery packs and battery modules
- Testing of large (low-resistance) cells
- Built-in contact check function

Battery HiTester BT3563A / BT3562A

	BT3563A	BT3563-01	BT3562A	BT3562-01
Maximum input voltage	Rated input voltage: ± 300 V DC Maximum rated voltage to ground: ± 300 V DC	Rated input voltage: ± 300 V DC Maximum rated voltage to ground: ± 300 V DC	Rated input voltage: ± 100 V DC Maximum rated voltage to ground: ± 100 V DC	Rated input voltage: ± 60 V DC Maximum rated voltage to ground: ± 70 V DC
Resistance measurement ranges	7 ranges: 3 m Ω (3.1000 m Ω , resolution of 0.1 $\mu\Omega$) to 3000 Ω (3000.0 Ω , resolution of 0.1 Ω)			
Voltage measurement ranges	3 ranges: 6 V DC (± 6.00000 V, resolution of 10 μV) to 300 V DC (± 300.000 V, resolution of 1 mV)	3 ranges: 6 V DC (± 6.00000 V, resolution of 10 μV) to 300 V DC (± 300.000 V, resolution of 1 mV)	3 ranges: 6 V DC (± 6.00000 V, resolution of 10 μV) to 100 V DC (± 100.000 V, resolution of 1 mV)	2 ranges: 6 V DC (± 6.00000 V, resolution of 10 μV) to 60 V DC (± 60.0000 V, resolution of 100 μV)
Sampling speed	EX.FAST: 4 ms; FAST: 12 ms; MEDIUM: 35 ms; SLOW: 150 ms			
Interfaces	External I/O, RS-232C, LAN	External I/O, RS-232C, GP-IB	External I/O, RS-232C, LAN	External I/O, RS-232C, GP-IB
Functions	Contact check, comparator, analog output (displayed values: 0 V to 3.1 V DC)			



- Support for direct measurement of up to 1000 V; maximum display range of ± 1100 V
- Testing of high-voltage battery packs for EVs and PHEVs
- Spark discharge reduction function
- Built-in contact check function

Battery HiTester BT3564

Maximum input voltage	Rated input voltage: ± 1000 V DC Maximum rated voltage to ground: 1000 V DC
Resistance measurement ranges	7 ranges: 3 m Ω (3.1000 m Ω , resolution of 0.1 $\mu\Omega$) to 3000 Ω (3100.0 Ω , resolution of 0.1 Ω)
Voltage measurement ranges	3 ranges: 10 V DC (± 9.99999 V, 10 μV) to 1000 V DC (± 999.999 V, 1 mV)
DC input resistance	5 M Ω
Sampling speed	3 speeds: FAST, MEDIUM, SLOW
Response time	Measurement response time: 700 ms
Interfaces	External I/O, RS-232C, GP-IB, analog output
Functions	Contact check, comparator, analog output (displayed values: 0 V to 3.1 V DC)

Selling separately: 100 V measurement leads (for measuring high-voltage batteries)

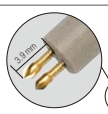

Pin Type Lead L2110
High-voltage battery measurement, 1000 V DC

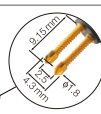

Pin Type Lead L2100
High-voltage battery measurement, 1000 V DC



Tip replacement (for either L2110 or L2100)
Tip Pin 9772-90
For replacing the tip of the Pin Type Lead L2110/ L2100



- High-accuracy measurement approaching the performance of a reference instrument with one-year accuracy of 9 ppm (DM7276)
- Low-cost base model with one-year accuracy of 20 ppm (DM7275)
- Built-in capacitance-type contact check function
- Universal power supply to accommodate global production

DC Voltmeter DM7275/DM7276

	DM7275-01, DM7275-02, DM7275-03	DM7276-01, DM7276-02, DM7276-03
Voltage measurement ranges	5 ranges: 100 mV (± 120.000 00 mV, resolution of 10 nV) to 1000 V (± 1000.000 0 V, resolution of 100 μV)	
Basic accuracy	10 V range $\pm 0.0020\%$ rdg. ± 12 μV	10 V range $\pm 0.0009\%$ rdg. ± 12 μV
Input resistance	100 mV to 10 V range: 10 G Ω or greater/10 M Ω 100 V, 1000 V range: 10 M Ω	
Temperature measurement	-10.0°C to 60.0°C, basic accuracy of $\pm 0.5^\circ\text{C}$ (Combined accuracy with Temperature Sensor Z2001)	
Interfaces	LAN (100Base-TX), external I/O, USB memory stick, USB device (USB 2.0 Full Speed) Optional interfaces GP-IB (DM7275-02, DM7276-02), RS-232C (DM7275-03, DM7276-03), printer (DM7275-03, DM7276-03)	
Functions	Measurement assistance: Smoothing function, null, temperature correction, scaling, over-display, auto-hold, contact check, self-calibration Management assistance: Comparator, bin judgment, absolute value judgment, level display, statistics, measurement information, communications monitor, external I/O test	



- **Impedance measurement**
R accuracy: $\pm(0.004 |R| + 0.0017 |X|)$ [m Ω] + α
X accuracy: $\pm(0.004 |X| + 0.0017 |R|)$ [m Ω] + α
(Representative α value: 8 dgt. during SLOW operation in 3 m Ω range)
- **Voltage measurement**
Resolution: 10 μ V; accuracy: $\pm 0.0035\%$ rdg. ± 5 dgt.
(Can measure 4 V at an accuracy of ± 190 μ V)
- **Temperature measurement**
Accuracy: $\pm 0.5^\circ\text{C}$ (10.0 $^\circ\text{C}$ to 40.0 $^\circ\text{C}$), $\pm 1.0^\circ\text{C}$ (-10.0 $^\circ\text{C}$ to 9.9 $^\circ\text{C}$, 40.1 $^\circ\text{C}$ to 60.0 $^\circ\text{C}$)
- Built-in contact check function

Battery Impedance Meter BT4560

Voltage measurement range	5 V (± 5.10000 V, resolution of 10 μ V), single range
Resistance measurement ranges	3 m Ω / 10 m Ω / 100 m Ω
Measurement current	3 m Ω range: 1.5 A rms, 10 m Ω range: 500 mA rms, 100 m Ω range: 50 mA rms
Measurement frequency	0.1 Hz to 1050 Hz
Functions	Contact check function, potential gradient correction during impedance measurement, charge/discharge prevention during AC application
Interfaces	RS-232C, USB

*Please consult us for special edition specifications (measurement voltage: 20 V, measurement frequency: 10 mHz).

Options: Probes and sensors

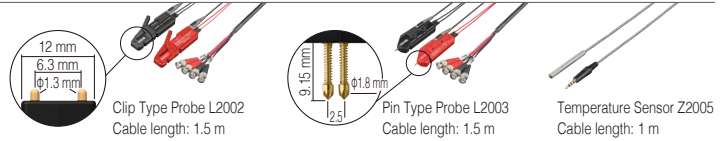

IM3570



9268-10



IM3590

*The 9268-10 and IM9000 (equivalent circuit analysis software, available for separate purchase) are required in order to perform equivalent circuit analysis with the IM3570.

Impedance Analyzer IM3570 Chemical Impedance Analyzer IM3590

	IM3570	IM3590	
Measurement modes	LCR measurement, sweep measurement, equivalent circuit analysis*, continuous measurement		
Measurement parameters	Z, Y, θ , Rs (ESR), Rp, Rdc (DC resistance), X, G, B, Cs, Cp, Ls, Lp, D (tan δ), Q, (IM3590 only: T, σ [conductivity], ϵ [permittivity])		
Measurement ranges	100 m Ω to 100 M Ω (defined in terms of Z for all parameters)		
Display range	Z, Y, Rs, Rp, Rdc, X, G, B, Ls, Lp, Cs, Cp: $\pm(0.000000$ [unit] to 9.999999 G [unit]) Z and Y: Displayed using absolute values θ : $\pm(0.000^\circ$ to $180.000^\circ)$ D: $\pm(0.000000$ to $9.999999)$ Q: $\pm(0.000000$ to $9.999999)$ T: $\pm(0.00$ to $99999.99)$	Z, Y, Rs, Rp, Rdc, X, G, B, Ls, Lp, Cs, Cp, σ , ϵ : $\pm(0.000000$ [unit] to 9.999999 G [unit]) Z and Y: Displayed using absolute values θ : $\pm(0.000^\circ$ to $180.000^\circ)$ D: $\pm(0.000000$ to $9.999999)$ Q: $\pm(0.00$ to $99999.99)$ σ , ϵ : $\pm(0.000000$ f [unit] to 999.999 G [unit])	
Basic accuracy	Z: $\pm 0.08\%$ rdg. θ : $\pm 0.05^\circ$	Z: $\pm 0.05\%$ rdg. θ : 0.03°	
Measurement frequency	4 Hz to 5 MHz	1 mHz to 200 kHz	
Measurement signal level	Normal V or CV mode	5 mV to 5 Vrms (up to 1 MHz), 10 mV to 1 Vrms (1.0001 MHz to 5 MHz)	5 mV to 5 Vrms
	Normal CC mode	10 μ A to 50 mArms (up to 1 MHz), 10 μ A to 10 mArms (1.0001 MHz to 5 MHz)	10 μ A to 50 mArms
	Low-impedance/high-accuracy V or CV mode	5 mV to 1 Vrms (up to 100 kHz)	5 mV to 2.5 Vrms
	Low-impedance/high-accuracy CC mode	10 μ A to 100 mArms (100 m Ω and 1 Ω ranges up to 100 kHz)	10 μ A to 100 mArms

- **IM3570**
Wide range of signal sources from 4 Hz to 5 MHz

- **IM3590**
Wide range of signal sources from 1 mHz to 200 kHz to accommodate ion behavior and solution resistance measurement
Capable of internal impedance measurement of batteries in the no-load state
Cole-Cole plots, equivalent circuit analysis, etc.
Capable of impedance (LCR) measurement of electrochemical components and materials

Switch Mainframe SW1001 / SW1002 Multiplexer Module SW9001 / SW9002



SW1001



SW9001



SW1002



SW9002

	Switch Mainframe SW1001/SW1002	
Number of slots	3 (SW1001), 12 (SW1002)	
Supported modules	Multiplexer Module SW9001 (2-wire/4-wire) Multiplexer Module SW9002 (4-terminal-pair)	
Number of connectable instruments	Max. of 2: one 2-wire instrument + one 4-wire instrument, or one 2-wire instrument + one 4-terminal-pair instrument	
Maximum input voltage	60 V DC, 30 Vrms AC, 42.4 Vpeak	
Interfaces	LAN, USB, RS-232C (for host and instrument)	
External I/O	SCAN input, SCAN_RESET input, CLOSE output (for scan control)	
	Multiplexer Module SW9001	Multiplexer Module SW9002
Connection type	2-wire or 4-wire	4-terminal-pair (6-wire)
Number of channels	22 (2-wire) or 11 (4-wire)	6 (4-terminal-pair) or 6 (2-wire)
Contact type	Armature relay	Armature relay
Channel switching time	11 ms (not including measurement time)	11 ms (not including measurement time)
Maximum allowable voltage	60 V DC, 30 Vrms AC, 42.4 Vpeak	60 V DC, 30 Vrms AC, 42.4 Vpeak
Maximum allowable current	1 A DC, 1 Arms AC	1 A DC, 1 Arms AC (sense) 2 A DC, 2 Arms AC (source, return)
Measurement connector	D-sub 50-pin	D-sub 37-pin

Product specifications *For more detailed specifications, please see the catalog for the product in question.



Multiplexer Unit Z3003 (option)

- Maximum resolution of 0.01 $\mu\Omega$, maximum measurement current of 1 A
- Measuring range of 0.00 $\mu\Omega$ (measurement current of 1 A)
- Multipoint measurement (20 four-terminal channels, RM3545-02 only) using the Multiplexer Unit Z3003 (selling separately)
- Built-in contact check function
- Ideal for busbar measurement

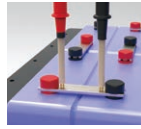

Use for busbar measurement.

Resistance Meter RM3545 / RM3545-01 / RM3545-02

Resistance measurement ranges	10 m Ω to 1000 M Ω
Measurement current	1 A to 100 nA DC
Temperature measurement	-10.0°C to 99.9°C; basic accuracy: $\pm 0.5^\circ\text{C}$ (combined accuracy with Temperature Sensor Z2001); -99.9°C to 999.9°C (analog input)
Sampling speed	FAST (2.0 ms), MED (50 Hz: 22 ms; 60 Hz: 19 ms), SLOW1 (102 ms), SLOW2 (202 ms) Speeds vary with the range; 2.0 ms is the fastest speed.
Functions	Temperature correction, offset voltage correction (OVC), comparator (ABS/REF%), bin judgment, panel save/load, D/A output, contact check
Multiplexer	Supported unit: Z3003 (up to 2, selling separately) (RM3545-02 only)
Interfaces	Select 1 of the following for use with remote function, communications monitor function, data output function, and memory (50 data points): GP-IB (RM3545-01 only), RS-232C, printer (RS-232C), USB



Electrode Resistance Measurement System RM2610

Measurement target	LIB positive electrode and negative electrode sheets
Measurement parameters	Interface resistance between composite layer and current collector [Ωcm^2] Volume resistivity of composite layer [Ωcm]
Calculation method	Analytical calculation based on potential distribution
Data entered in advance	Composite layer thickness [μm] Current collector volume resistance [Ωcm] and thickness [μm]
Measurement time	1 min. standard (measurement time + analysis time)
Measurement probe	46 measurement pins
System components	Instrument, measurement probe, computer (provided by user)

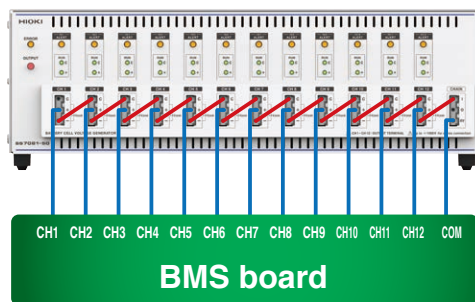

12 channel connection example

Battery Cell Voltage Generator SS7081-50

Number of channels	12
Maximum series connections	Series connections with instrument up to a maximum serial output voltage of 1000 V
Output range (All channels are independent.)	DC voltage: 0.0000 V to 5.0250 V Maximum output current $\pm 1.000\ 00\ \text{A}$ Continuous output within the range of -210 mA to 210 mA Maximum output time of 200 ms if output is less than -210 mA or greater than 210 mA
Measurement ranges	DC voltage -0.00100 V to 5.10000 V DC current (2 ranges) $\pm 120.0000\ \mu\text{A}$ (100 μA range), $\pm 1.200\ 00\ \text{A}$ (1 A range)
Voltage output accuracy	$\pm 0.0150\%$ of setting $\pm 500\ \mu\text{V}$
Voltage measurement accuracy	$\pm 0.0100\%$ rdg. $\pm 100\ \mu\text{V}$
Current measurement accuracy	1 A range $\pm 0.0700\%$ rdg. $\pm 100\ \mu\text{A}$ 100 μA range $\pm 0.0350\%$ rdg. $\pm 10\ \text{nA}$
Functions	Assistive functionality: smoothing, logging measurement, memory output, output pin switching (open, short simulation) Anomaly detection functionality: Overcurrent detection, output voltage anomaly detection, enclosure temperature anomaly detection
Power supply	Universal (100 V to 240 V AC)
Interface	LAN



Power Analyzer PW6001

Functions	Measurement of voltage/ current/ and power, calculation measurement, harmonic measurement, waveform recording, FFT analysis, efficiency and loss calculation, user-defined calculations, trend graph display, X-Y graph display, D/A output, etc.
Number of channels	Max. 6 (by channel when measuring voltage and current simultaneously)
Voltage ranges	6 to 1500 V, 7 ranges
Current ranges	400 mA to 2 kA (varies with current sensor)
Sampling	5 MHz/18 bits
Frequency band	DC, 0.1 Hz to 2 MHz
Power accuracy	$\pm 0.02\%$ rdg. $\pm 0.05\%$ f.s.(DC) $\pm 0.02\%$ rdg. $\pm 0.03\%$ f.s.(45 to 66Hz)
Data refresh rate	10 ms/ 50 ms/ 200 ms
Interfaces	USB memory stick, LAN, GP-IB, RS-232C, external control, 2-instrument synchronization



Examples of optional current sensors (selling separately)

AC/DC Current Probe CT6846-05
1000Arms
AC/DC Current Sensor CT6877
2000Arms

CT6846-05

CT6877



- Get decisions in as quickly as 50 ms
- Freely configurable test voltage (1 V resolution, settings from 25 to 1000 V)
- Built-in contact check function (to prevent erroneous judgments caused by faulty contact)

Insulation Tester ST5520 / ST5520-01

Measurement parameters	Insulation resistance (DC voltage application method)
Test voltages and measurement ranges (auto/manual)	25 V ≤ V < 100 V (2.000/20.00/200.0 MΩ) 100 V ≤ V < 500 V (2.000/20.00/200.0/2000 MΩ) 500 V ≤ V ≤ 1000 V (2.000/20.00/200.0/4000/9990 MΩ)
Basic accuracy	±2% rdg. ±5 dgt. 25 V ≤ V < 100 V [0 to 20 MΩ] 100 V ≤ V < 500 V [0 to 20 MΩ] 500 V ≤ V ≤ 1000 V [0 to 200 MΩ]
Sampling speed	FAST: 30 ms/sample; SLOW: 500 ms/sample (switchable)
Functions	Saved data: Rated measurement voltage value, comparator upper and lower limits, test mode, judgment beep tone, test time, response time, resistance range, measurement speed Memory capacity: Max. 10 sets (with saving and loading) Contact check function
Interfaces	RS-232C, external I/O, BCD output (ST5520-01)



- Noise resistance that is 300 times greater than that of the previous model
- High-speed measurement as fast as 6.4 ms
- Built-in contact check function to verify contact
- Max. 2×10¹⁹ Ω display and 0.1 fA resolution

Super Megohmmeter SM7110 / SM7120

DC current measurement (accuracy)	20 pA range (resolution of 0.1 fA and accuracy of ±[2.0% of rdg. +30 dgt.] to 2 mA range (resolution of 10 nA and accuracy of ±[0.5% of rdg. +30 dgt.]
Resistance display range	50 Ω to 2×10 ¹⁹ Ω
Voltage measurement ranges (accuracy)	SM7110 and SM7120 0.1 to 100.0 V (resolution of 100 mV and accuracy of ±0.1% of setting ±0.05% f.s.) 100.1 to 1000 V (resolution of 1 V and accuracy of ±0.1% of setting ±0.05% f.s.) SM7120 only 1000 to 2000 V (resolution of 1 V and accuracy of ±0.2% of setting ±0.10% f.s.)
Current limiter	0.1 to 250.0 V: 5/10/50 mA; 251 to 1000 V: 5/10 mA; 1001 V or greater: 1.8 mA
Functions	Comparator, liquid volume resistivity measurement, surface resistivity measurement, volume resistivity measurement, voltage monitor, contact check
Interfaces	RS-232C, USB, GP-IB



- As little as approx. 2 sec. from measurement to saving of data
- Measure internal resistance and voltage to instantaneously diagnose the state of degradation as "pass," "caution," or "fail."
- Built-in noise reduction technology for improved noise resistance
- Bluetooth® wireless technology for real-time degradation diagnostics (When Wireless Adapter Z3210 is installed)
- New protector delivers better ergonomic hold and durability in the field

Battery Tester BT3554-50

Resistance measurement ranges	4 ranges (switchable): 3 mΩ (max. display of 3.100 mΩ and resolution of 1 μΩ) to 3 Ω (max. display of 3.100 Ω and resolution of 1 mΩ) Measurement accuracy: ±0.8% rdg. ±6 dgt. (3 mΩ range only: ±1.0% rdg. ±8 dgt.) Measurement current frequency: 1 kHz ±30 Hz; with noise frequency avoidance function enabled: 1 kHz ±80 Hz Measurement current: 160 mA (3 m/30 mΩ range), 16 mA (300 mΩ range), 1.6 mA (3 Ω range); open-terminal voltage: 5 V max.
Voltage measurement ranges	2 ranges (switchable): ±6 V (max. display of ±6.0000 V and resolution of 1 mV) to ±60 V (max. display of ±60.00 V and resolution of 10 mV) Measurement accuracy: ±0.08% rdg. ±6 dgt.
Functions	Contact check, comparator, memory (6000 data points)
Interfaces	USB Bluetooth® wireless communications (When Z3210 installed)



LR8410 and LR8510 (right) (separately available option)

- Wireless logger capable of collecting data from multiple channels using Bluetooth® technology to enable measurement in locations where it would be difficult to run wires (line of sight, 30 m)
- Add up to 7 input units (for 105 channels when using 15-channel type units) for simple, wireless expansion.
- Collect data with high-speed sampling of all channels at up to 100 ms.

Wireless Logging Station LR8410

Number of measurement channels	Connect up to 7 input units wireless (with Bluetooth® wireless technology) to the LR8510 or LR8511 for measurement and data collection across up to 105 channels.
Recording interval	16 settings: 100 ms, 200 ms to 1 hr. (All input channels are scanned within the recording interval.)
Memory capacity	Internal memory: 8 Mwords; SD card/USB memory stick
Interfaces	LAN: 100Base-TX; USB: USB 2.0 series mini-B × 1
Functions	Real-time saving to SD card or USB memory stick, value/waveform calculations, 4-channel alert output (non-isolated), etc.
LR8510 measurement functionality	Number of channels: 15 isolated channels of analog scanning input (2-pole terminal block with M3 screws) Voltage measurement range: ±10 mV to ±100 V, 1 to 5 V, resolution of 500 nV Thermocouple measurement range: -200°C to 2000°C, thermocouple (K, J, T, other), resolution of 0.01°C
LR8511 measurement functionality	Number of channels: 15 isolated channels of analog scanning input (4-pole push-button terminal block) Voltage measurement range: ±10 mV to ±100 V, 1 to 5 V, resolution of 500 nV Thermocouple measurement range: -200°C to 2000°C, thermocouple (K, J, T, other), resolution of 0.01°C Resistance bulb measurement range: -200°C to 800°C, resolution of 0.01°C (non-isolated channels) Resistance measurement range: 0 to 200 Ω, resolution of 0.5 mΩ (non-isolated channels) Humidity measurement range: 5.0 to 95.0% RH, resolution of 0.1% RH (non-isolated channels) Maximum channel-to-channel voltage: 300 V DC Maximum input voltage: ±100 V DC Maximum voltage to ground: 300 V AC/DC



Cell

Consists of a positive and negative electrode.



Module

Consists of multiple cells.



Pack

Consists of multiple modules.

Comparison of battery tester specifications

Model ▼	Measurement frequency	Measurable battery voltage	Measurement ranges	Measurement method	Maximum measurement current
BT4560	0.1 Hz to 1050 Hz	5 V	3 mΩ to 100 mΩ 3 ranges	4-terminal-pair	1.5 Arms
3561	1 kHz	20 V	300 mΩ to 3 Ω 2 ranges	4-terminal	10 mArms
BT3562A	1 kHz	100 V	3 mΩ to 3000 Ω 7 ranges	4-terminal	100 mArms
BT3563A	1 kHz	300 V	3 mΩ to 3000 Ω 7 ranges	4-terminal	100 mArms
BT3564	1 kHz	1000 V	3 mΩ to 3000 Ω 7 ranges	4-terminal	100 mArms
BT3554-50	1 kHz	60 V	3 mΩ to 3 Ω 4 ranges	4-terminal	160 mArms

Difference between 4-terminal and 4-terminal-pair measurement methods

The 4-terminal-pair measurement method can be used to reduce the effects of inductive fields compared to conventional 4-terminal measurement, including the effects of cable routing, eddy currents caused by nearby metals, and interference caused by the simultaneous use of multiple instruments.

Comparison of LCR meter specifications

Model ▼	Measurement frequency	Measurable battery voltage	Measurement ranges	Measurement method	Maximum measurement current
IM3570 + 9268-10	40 Hz to 5 MHz	40 V DC max.	100 mΩ to 100 MΩ 12 ranges	4-terminal	100 mArms
IM3590	1 mHz to 200 kHz	5 V DC max.	100 mΩ to 100 MΩ 10 ranges	4-terminal-pair	100 mArms

Comparison of insulation resistance meter (high-resistance tester) specifications

Model ▶	ST5520	SM7110	SM7120
Resistance measurement range	$4 \times 10^{10} \Omega$	$2 \times 10^{19} \Omega$	
Output voltage range	25 V to 1000 V 1 V steps	0.1 V to 1000 V 0.1 V steps	0.1 V to 2000 V 0.1 V steps
Maximum output current	Max. 2 mA	Max. 50 mA	
Measurement time	Min. 50 ms	Min. 6.4 ms	
Measurement accuracy	$\pm 2\%$ rdg. ± 5 dgt.	$\pm 0.5\%$ rdg. ± 10 dgt.	
Contact check	4-terminal	2-terminal (capacitive measurement method)	
Measurement method	Constant-voltage method	Constant-voltage method	
Principal purpose	Verification of isolation of insulated parts	High-resistance measurement (evaluation of properties and characteristics), surface/volume resistance, etc.	

Note: Company names and product names appearing in this catalog are trademarks or registered trademarks of various companies.

HIOKI
HIOKI E. E. CORPORATION

HEADQUARTERS
81 Koizumi,
Ueda, Nagano 386-1192 Japan
<https://www.hioki.com/>



Scan for all regional contact information

DISTRIBUTED BY