



Eliminate the risk of short-circuits and electrical accidents



The world's first instrument to offer no-metal-contact power measurement

Free from the risk of short-circuit accidents since no metal comes into contact with energized parts, the Clamp On Power Logger PW3365-20 can measure voltage, current, and power right on the cable, letting you safely test in locations that were dangerous or even impossible in the past.



*For Voltage Sensor PW9020

Safe, Easy, Voltage Measurement

The PW3365-20's dedicated voltage sensor delivers the world's first no-metal-contact measurement.

Free yourself from the risk of short-circuits by measuring right on the cable sheath without ever needing to touch metal to energized parts

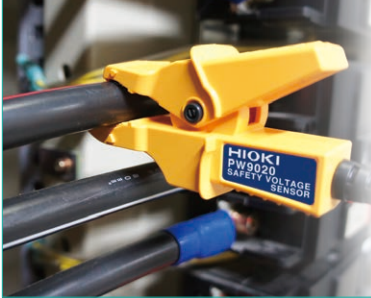

Freely clip either horizontally or vertically



Measure both thick and thin cables

Measure in potentially hazardous locations



Locations without energized parts

Measure on the outside of cables



Locations with covered terminals

Measure without removing the covers

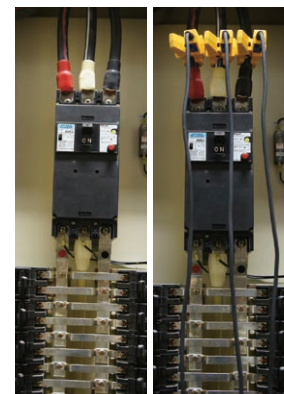

Locations with a risk of electric shock

Measure at safer points

How is voltage measured without any metallic contact?

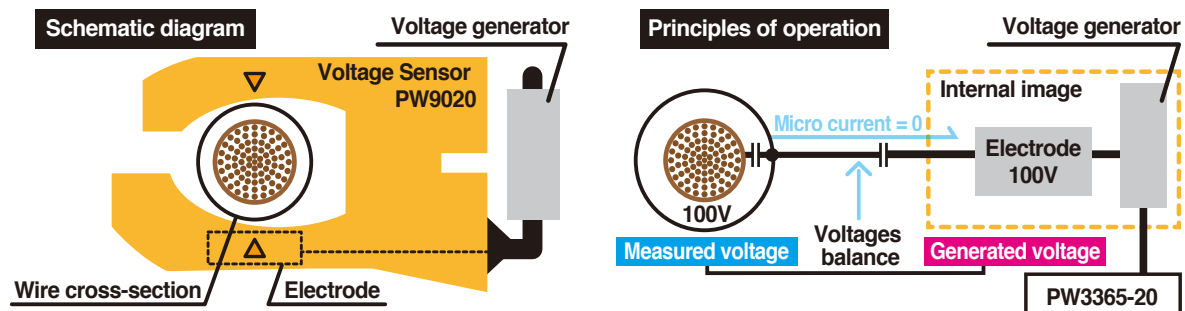

Inside the PW9020 is an electrode (a metal plate). When there is a potential difference between this electrode and the measured line, a minute current flows as a result. By detecting this minute current and generating a voltage such that the current declines to zero, it is possible to accurately measure the voltage without being affected by the outer diameter of the measured cable or its insulation.



Enlarged view of clamp

Actual maximum size : $\phi 30$ mm
Actual minimum size : $\phi 6$ mm

Compatible conductor diameters

SAFETY VOLTAGE SENSOR PW9020 Specifications

Compatible conductor types	Insulated wires*1 In door PVC or metal parts
Compatible conductor diameters	Finished outer diameter $\phi 6$ mm to $\phi 30$ mm
Effective measurement range	90 V rms to 520 V rms
Accuracy	$\pm 1.5\%$ rdg. ± 0.8 V (combined accuracy with PW3365-20)*2
Effect of phase	Accuracy combined with the PW3365-20 is within $\pm 1.3\%$ (at 50 Hz/60 Hz, f.s. input)
Maximum rated voltage to earth	CATIV 300V / CATIII 600V
Cord length	3m (9.84 ft)
Mass	Approx. 220g (7.8 oz)
Operating temperature and humidity	0°C to 50°C (32°F to 122°F), 80% RH or less (no condensation)
Storage temperature and humidity	-10°C to 60°C (14°F to 122°F), 80% RH or less (no condensation)
Dielectric strength	7.06k Vrms AC
Applicable standards	Safety: EN61010, EMC: EN61326



* includes relay box on cord



Soil, residue, or moisture on the insulated wires may result in lower voltage and power values than their true values. Use a dry cloth to remove before measuring.

*1: Shielded wires cannot be measured. The product may not be able to accurately measure multi-core cables or cables that have thick insulation.

*2: For frequencies of 45 Hz to 66 Hz.

Effects of humidity: Add the following to the combined accuracy (for voltage, power, and phase) with the PW3365-20
Accuracy within $\pm 1\%$ f.s., phase within $\pm 1^\circ$,
measuring an insulated wire at a humidity of 70% to 80% RH
Effects of adjacent wires: Add the following to the combined accuracy (for voltage and power) with the PW3365-20
Within $\pm 1\%$ f.s. while a wire with a phase difference of 400 V is in contact with the grip

Review Results At the Worksite

Display measured values as a graph and evaluate results at a glance

Measured values can be displayed as a graph, which is convenient when using the instrument in power management applications. Since you can statistically review not only the measured value at that moment, but also measured values that have been recorded, it's easy to check values on the spot.

Parameter List and Waveform Displays

Select a display with the screen selection button

Review a list of principal test parameters, including voltage, current, power, frequency, and energy

Select the WAVE display to check voltage and current waveforms.



List display screen

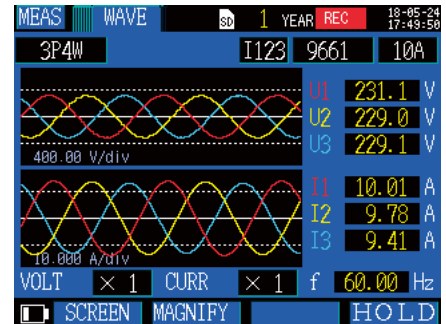

Waveform display screen

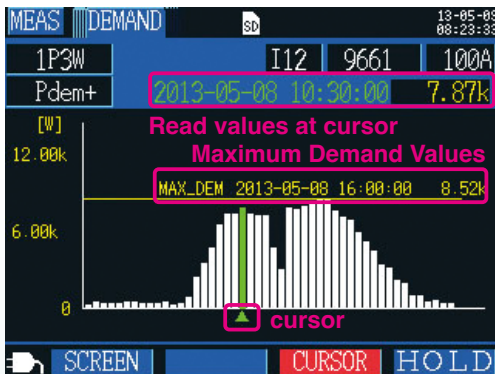

Bar graph of values measured over a period of 24 hours at a 30-minute interval

Demand Graph Display

Display demand value trends

It's easy to check the maximum demand value and the time at which it occurred.

Particularly useful in power management applications

Evaluate Photovoltaic Generation Capabilities



You can create a bar graph that makes it obvious whether power is being bought or sold by switching the active power demand value display from consumption to regeneration

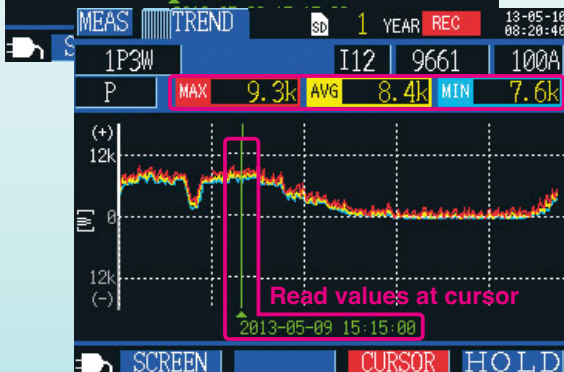
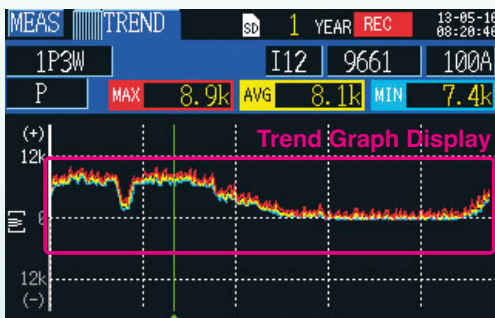

Graph of values measured over a period 24 hours at 5-minute intervals

Trend Graph Display

* Except for demand

Choose one measured parameter to create a time-series display as a graph

Monitor power variations to check for connections between equipment operating status and power consumption.

Display the maximum, minimum, and average values at the cursor position

Identify these parameters right on the time-axis graph display

Example Power trend graph display

- MAX 9.3k Maximum Value
- MIN 7.6k Minimum Value
- AVG 8.4k Average Value

Capture and record all fluctuations

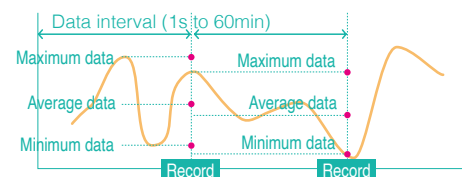

Set the power logger to save all parameters to record the maximum, minimum, and average values during the set recording interval.

Configure Settings with Quick Set

Graphical, easy-to-understand guidance for connection procedures

Quick Setup guides you through the process of setting up the instrument for measurement, right up to starting measurement, on the screen to simplify set work. Since any mistaken connections will trigger a FAIL message, the feature also helps prevent measurement mistakes. If you receive a FAIL result, the instrument will also indicate the location of the problem.



Setup Flow (example: 3P4W)

STEP1 Quick Set START / Choose the wire type

STEP2 Connect the leads to the PW3365-20



STEP3 Connect the voltage sensor

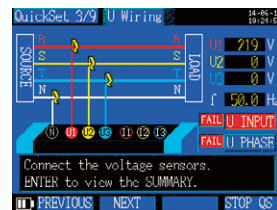

STEP4 Connect the clamp sensors

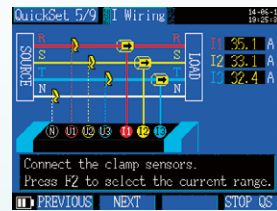

STEP5 Select the current range

STEP6 Check wire connection status

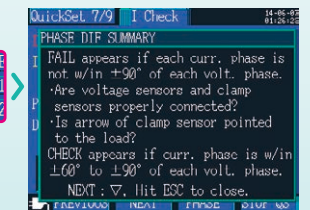
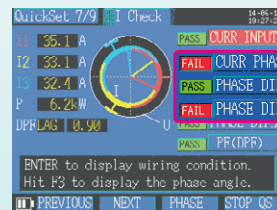

If you receive a FAIL result

Highlight the FAIL message with the cursor and press ENTER to view information about where the connection needs to be corrected.

Measurement

Miswiring Example (Clamp Orientation)

Neither power nor power factor can be measured accurately with the clamp in the wrong orientation.

Correct Orientation
Point the arrow toward the load side

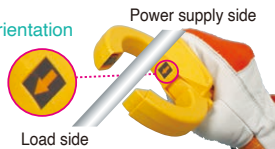

FAIL The I vector's phase direction is opposite the determination area.

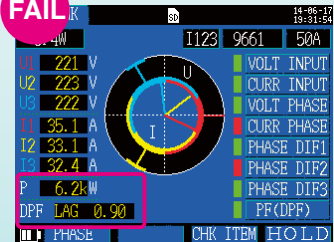

P: 6.2 kW
Power displayed value is too low

PASS The I vector's phase direction is within the determination area.



P: 17.8 kW

CURR PHASE Red means : FAIL **VOLT PHASE** Green means : PASS

Safely and Easily

Measure Harmonic

Measure harmonics with no-metal-contact voltage measurement technology

This useful feature has come to the PW3365, enabling the instrument to measure voltage and current harmonics in addition to power. Hioki's no-metal-contact voltage measurement technology lets you safely and easily measure THD and the dominant 5th- and 7th-order harmonics.

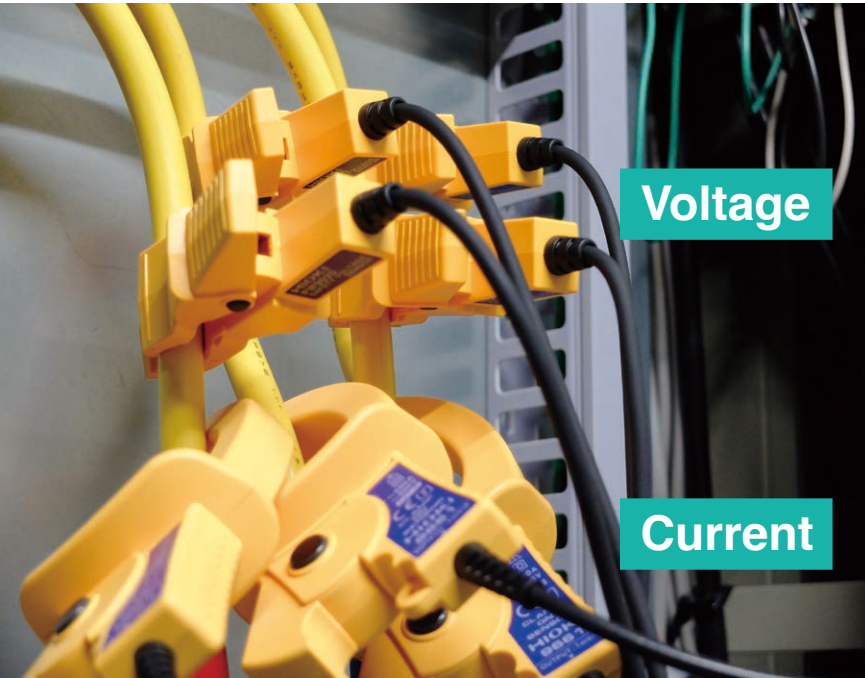

Measurement parameters

- Harmonic voltage
- Harmonic current
- Voltage total harmonic distortion
- Current total harmonic distortion

Screen displays

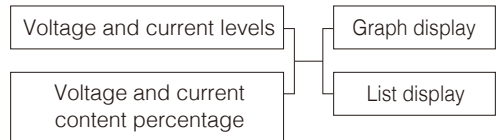

Harmonic Display

Display harmonics up to the 13th order

Present harmonic RMS values and content percentages as a list of numerical values or graph and display total harmonic distortion ratio.

The PW3365 can analyze voltage and current harmonic components from the fundamental wave to the 13th order on 50 Hz/60 Hz power lines.

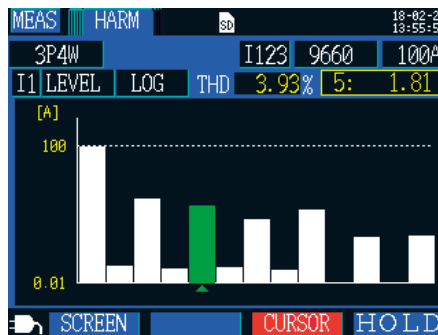

Harmonic Graph Display

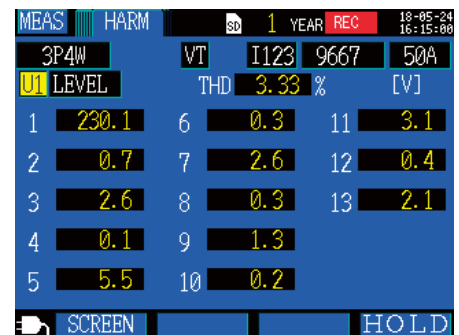

Harmonic Value List Display

You can save maximum, average, and minimum values in binary format for each time interval to the instrument's SD card.

The Power Logger Viewer SF1001 is required in order to display data on a computer.



Time-series display of harmonics

Select the fundamental wave, 3rd order, or 5th order for current harmonics to display a time-series graph.

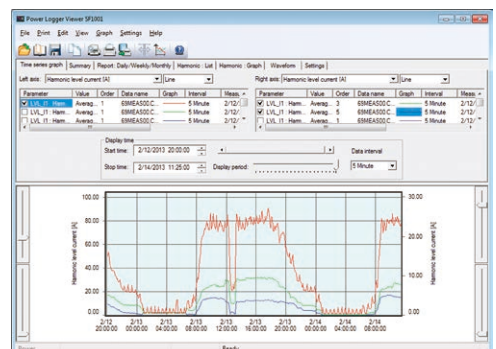

What causes harmonics?

Many electric devices incorporate power circuits with capacitor input. Such devices have rectification circuits to convert the AC power supply to DC power, and distortion in the resulting voltage and current waveforms causes harmonics.

Power circuits that distort waveforms

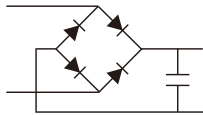

Typical power circuit

Voltage waveform and current waveform

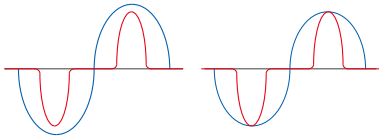

Current flows only near the peak of the voltage waveform, resulting in a voltage drop that flattens the peak portion of the voltage waveform.



Analysis points

Waveform as measured by an instrument designed for observing harmonics

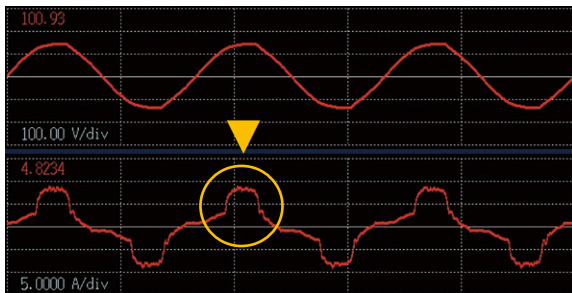

Current flows only near the peak of the voltage waveform

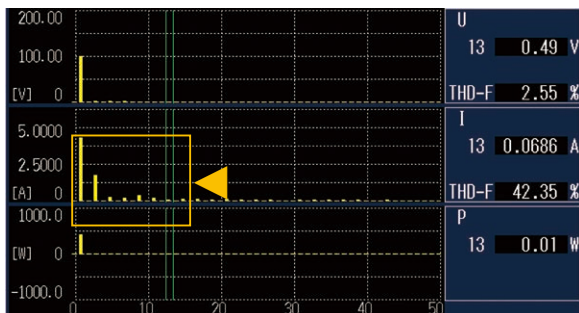

THD and dominant orders



Waveform as measured by the PW3365

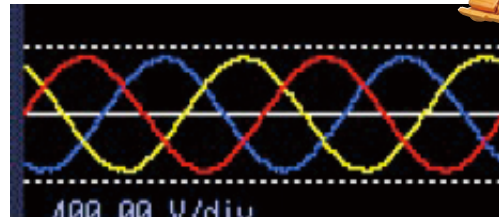

The PW3365 displays content percentages for each harmonic voltage order as well as the voltage total harmonic distortion (THD).

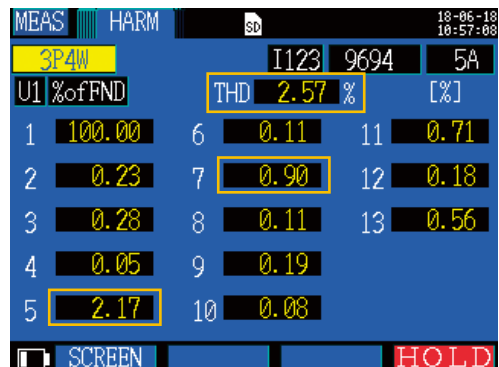

The instrument is especially useful for measuring the dominant 5th and 7th orders.

Convenient Functions For the Worksite

More Uses for the PW3365-20

The Hioki PW3365-20 is not just a power logger. Added-value features and functions let you meet many other electrical testing applications.

Leakage Current Measurement

Requires optional clamp-on leak sensor

Measure power + 1-channel of leakage current

Example : 3P3W2M+1-channel leakage current

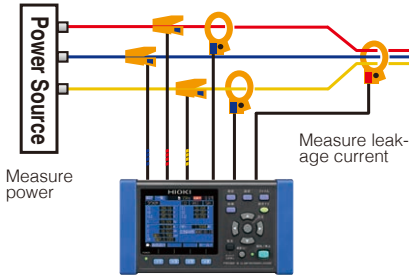

With the ability to calculate and process data every 200ms, you can do simple checks of intermittent leakage current. Choose from average, maximum and/or minimum value of the measured interval.

Leakage current results

MEAS	U/I	I3	9675	50mA
3P3W2M+1				
U1	RMS (V)	FND (V)	PEAK (V)	PHASE (deg)
U2	224.4	224.4	321.1	0.0
U12	223.3	223.3	326.0	59.9
U12	223.5	223.5	322.5	-59.9
I1	RMS (A)	FND (A)	PEAK (A)	PHASE (deg)
I2	23.420	19.934	33.475	-79.9
I12	22.079	18.952	44.459	90.3
I12	25.604	19.445	62.660	-152.5
I3	27.004m	24.924m	50.069m	59.5
	SCREEN			HOLD

By capturing the RMS of the fundamental wave, you can also identify the leakage current of the 50/60Hz component.

- RMS (A) RMS that includes harmonic components
- FND (A) RMS of fundamental wave
- PEAK (A) Peak value (waveform peak)

Measure 3 channels of leakage current

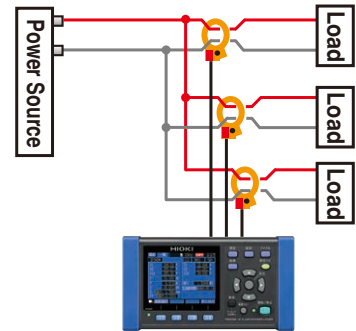

Control and Monitor from a Remote Location

Use a LAN cable to connect the PW3365-20 to a personal computer for real-time remote monitoring and measurement display on a web browser.

Files recorded in the Clamp On Power Logger's internal memory or SD card are accessible via a LAN or USB connection, and are downloadable using the free PW3365-20 Setup and Download Software

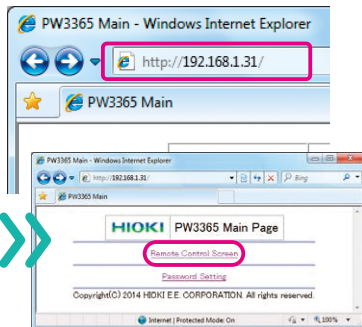

Enter the IP address in the browser.

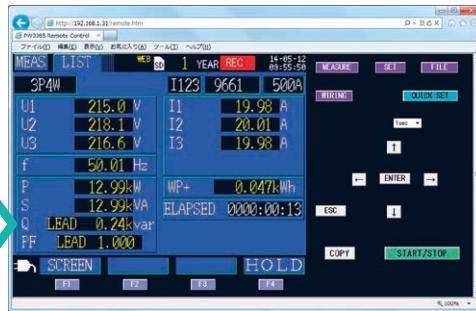

Display the power logger's screen and make adjustments virtually by clicking the buttons and entering new information.

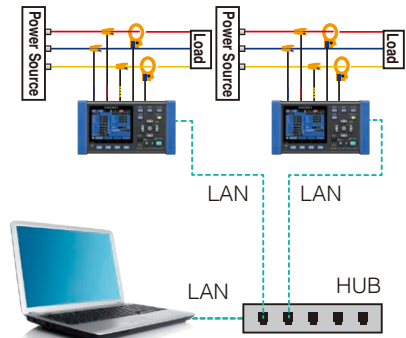

Simultaneous Measurements

Measure three single-phase, 2-wire circuits in the same system at the same time.

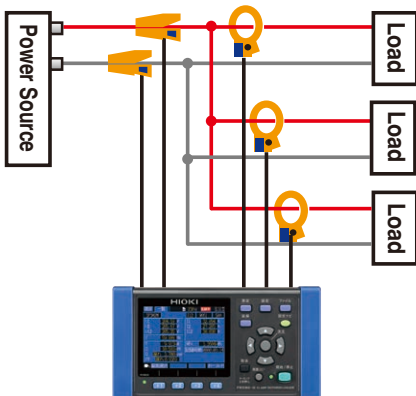

Other Convenient Features



Compact, lightweight

Small form factor lets you set the power logger even inside cramped cubicles



Battery power

Power the instrument for about three hours with batteries if the power goes out



Outage recovery

Resume recording automatically following recovery from a power outage

Key lock function

Lock the buttons to prevent erroneous operation

Display hold

Freeze the displayed value for easier reading

Save & Analyze

Measurement Results on PC

Easily download and interpret data on a PC

Download the measurement results to a computer via the power logger's LAN or USB interface or its SD card. Simultaneously monitor all data in real-time, control your device and download the recorded data remotely with GENNECT One software. For more detailed analysis, Hioki's optional SF1001 application software is recommended.

Storage media for data

SD card 2GB

Stores up to one year's data that is acquired at one minute intervals. Performance cannot be guaranteed on storage media other than SD cards sold by Hioki.



Loading data

SD card 2GB

LAN interface

USB interface



Available Recording Time

Interval time	Save Time		Interval time	Save Time	
	Saving of harmonic data: OFF	Saving of harmonic data: ON		Saving of harmonic data: OFF	Saving of harmonic data: ON
1 seconds	14 days	2 days	30 seconds	1 year	79 days
2 seconds	29 days	5 days	1 minutes	1 year	158 days
5 seconds	73 days	13 days	2 minutes	1 year	316 days
10 seconds	146 days	26 days	5 minutes	1 year	1 year
15 seconds	219 days	39 days	More than 10 minutes	1 year	1 year

[Save conditions for above figures]

Measurement target : 3P4W

Storage media : Z4001 2-GB SD card

Saved parameters : All data: average, maximum, and minimum values

Screen copy saving : OFF Waveform save : OFF

In all cases, the maximum single file size for measurement data is about 200 MB. When this is exceeded, a new file is created and saving continues. The maximum recording period is one year.

GENNECT One SF4000 (available as a free download from the HIOKI website)

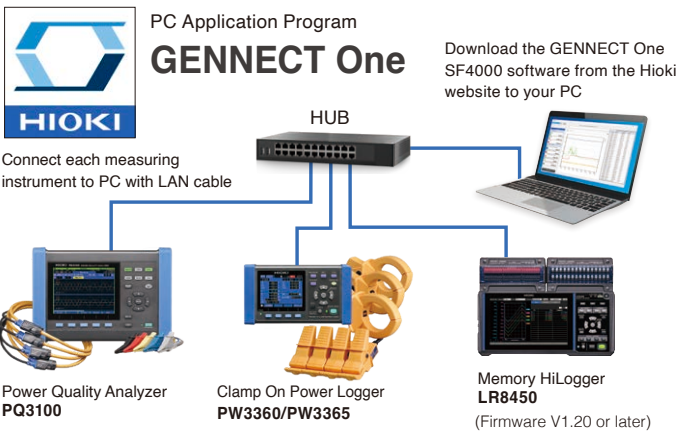

Real-time measurement (logging)

- Regularly (as quickly as once every second) collect measurement data from up to 30 LAN-connected measuring instruments and display it on a computer.
- Simultaneously capture power data from a power meter and temperature or flow rate data from a data logger.

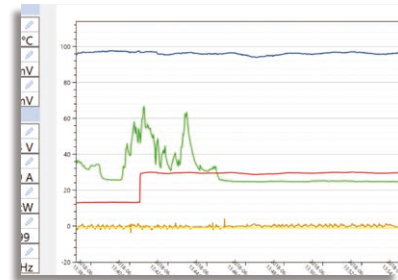

Remote control (HTTP)

Control and configure LAN-connected measuring instruments in remote locations from a computer

The application displays a virtual instrument and allows you to control it directly with the mouse.



You can also easily change instrument settings and control the instrument, for example to start and stop measurement

Automatic file transfer (FTP)

Automatically transfer measurement files from LAN-connected instruments to a computer

This function lets you acquire data in real time on a PC, including data created when the instrument's trigger is activated and measurement files that are automatically generated on a daily basis. Example uses include capturing abnormal phenomena with an instrument installed in the field and automatically acquiring daily power consumption data on a PC.

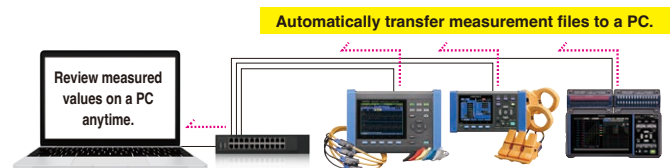

Downloading GENNECT One SF4000 (for Windows)

HIOKI website > Search

Model No. (Order code)

SF4000

Search

Enter the model number in the search field to download the software to get started!

Save & Analyze

Measurement Results on PC

Use Hioki's Power Logger Viewer to gather, view, and compare data

Assessing the status quo is the first step in saving energy. Ascertain trends by simultaneously measuring the energy needed to maintain environmental conditions and the energy needed for production by using as many individual instruments as possible throughout plants and on individual department floors. Hioki's Power Logger Viewer SF1001 lets you download data saved at sites in the field to instruments' SD cards and internal memory to a computer to display, tabulate, analyze, and incorporate it into printed reports.

Collect data that reflects changes in multiple locations and compare to gain an understanding of the big picture

Example data use case 1

Simultaneously measure and record loads using three PW3365s.

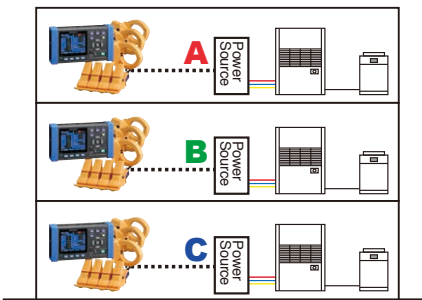

Building A

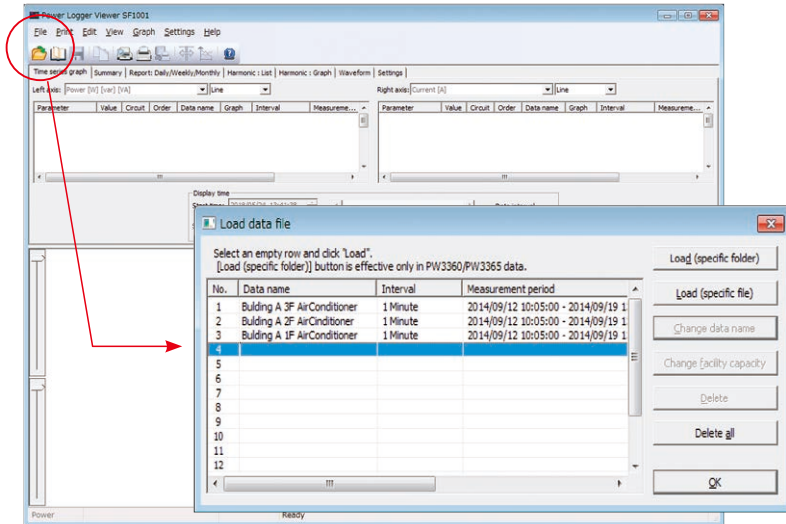

You can load data from multiple instruments.

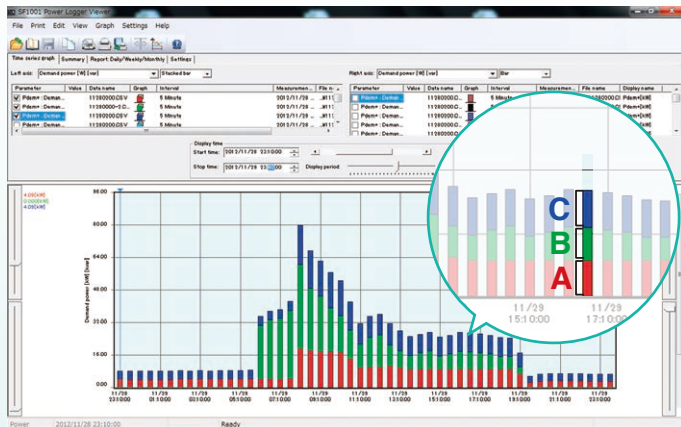

Display easy-to-understand time-series graphs

Choose a line graph or bar graph depending on your purpose.

Consolidate data

Consolidate up to 16 sets of data into a single file so that it can be loaded more quickly.

Group power consumption data for multiple locations together and display on a single graph so that you can readily identify the times and locations that are characterized by high power consumption.

Example data use case 2

Display data for measurements made at different times on a single graph

Functionality for changing the date associated with a set of data lets you change the time of data to facilitate comparison so that you can identify the benefits of energy-saving measures at a glance.

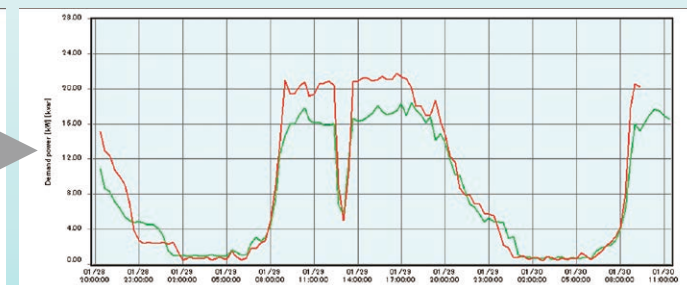
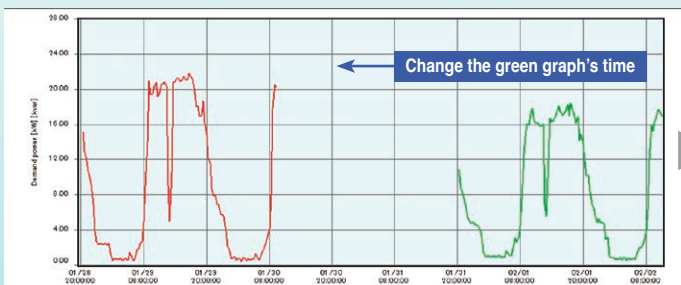

Generate daily and weekly reports to review survey results and benefits

Daily report

Time	Pdem+[kW]	WP+[kWh]	U1[V]	U2[V]	U12[V]	I1[A]	I2[A]	I12[A]
00:30:00	3.955	50.9684	206.08	207.43	206.83	14.220	16.392	14.989
01:00:00	0.105	51.0219	207.13	206.41	206.71	0.425	0.314	0.461
01:30:00	4.152	53.0577	207.66	209.82	207.31	14.521	16.854	15.330
02:00:00	2.826	54.5106	207.34	206.98	206.98	10.062	11.824	10.995
02:30:00	0.068	54.5443	207.71	206.94	207.31	0.289	0.137	0.300
03:00:00	4.527	56.8079	207.45	206.59	206.94	15.917	18.247	17.028
03:30:00	2.044	57.8266	206.18	206.22	207.59	7.296	8.296	7.517
04:00:00	0.464	58.0617	208.12	206.24	207.85	1.701	1.792	1.836
04:30:00	4.998	60.3669	206.28	206.43	207.88	16.181	18.251	17.252
05:00:00	1.883	61.2024	206.08	206.27	207.98	6.100	7.058	6.839
05:30:00	0.590	61.4823	207.99	206.11	207.83	2.073	2.184	2.164
06:00:00	4.524	63.7441	207.63	206.80	207.63	16.319	18.286	16.703
06:30:00	1.032	64.2663	207.13	206.37	207.28	3.935	4.462	4.075
07:00:00	1.715	65.1179	206.51	207.85	206.96	6.290	6.658	6.243
07:30:00	4.069	67.1522	206.63	207.96	206.87	14.870	16.660	15.109
08:00:00	0.298	67.3012	206.16	206.63	206.59	1.188	1.219	1.225
08:30:00	3.202	68.9253	206.53	206.05	206.65	11.504	12.951	11.517
09:00:00	3.419	70.6120	206.16	207.85	206.35	12.501	14.411	12.950
09:30:00	1.962	71.9553	206.27	206.97	206.33	7.337	8.961	8.180
10:00:00	2.057	72.6220	204.93	206.69	204.97	7.643	9.309	8.484
10:30:00	2.405	73.8247	205.46	207.14	205.47	8.657	10.504	9.611
11:00:00	3.874	75.7616	204.94	206.63	204.95	13.900	15.829	14.413
11:30:00	3.581	77.3519	204.77	206.58	204.91	12.952	14.927	13.483
12:00:00	3.750	78.4268	204.64	206.45	204.72	13.459	15.426	13.949
12:30:00	4.047	81.4501	205.12	206.82	205.17	14.471	16.392	14.845
13:00:00	2.969	82.9345	204.58	206.26	204.60	10.729	12.421	11.345
13:30:00	2.276	84.1226	205.92	207.89	205.03	8.650	10.216	9.415
14:00:00	4.691	86.4528	206.03	207.79	206.09	15.953	18.327	16.378
14:30:00	5.327	89.1163	205.78	207.55	205.81	18.356	20.610	18.650
15:00:00	1.517	89.8750	206.98	207.69	206.35	5.365	5.652	5.642
15:30:00	4.039	91.8642	207.00	206.88	207.02	13.800	15.454	13.550
16:00:00	4.528	94.1581	206.70	206.40	206.70	15.909	17.784	16.257
16:30:00	3.462	95.8890	206.69	206.41	206.71	12.381	14.159	12.920
17:00:00	2.386	97.0821	206.95	206.70	207.08	8.233	10.318	9.363
17:30:00	3.426	98.7850	207.32	206.16	207.48	12.224	14.203	12.788
18:00:00	3.514	100.5520	206.81	206.58	206.88	12.589	14.621	13.204
18:30:00	3.490	102.2970	207.13	206.94	207.15	12.521	14.580	13.209
19:00:00	3.478	104.0300	207.31	206.11	207.33	12.318	14.618	13.200
19:30:00	3.447	105.7600	207.55	205.28	207.48	12.181	14.473	13.099
20:00:00	2.124	106.8210	206.80	206.49	206.78	7.850	9.052	8.193
20:30:00	1.231	107.6820	206.76	207.38	205.71	6.045	6.666	6.149
21:00:00	4.295	109.8340	206.22	207.81	206.20	15.284	17.667	15.799
21:30:00	2.556	111.1120	206.03	207.60	206.94	9.373	11.393	10.163
22:00:00	1.894	112.0560	207.52	205.93	207.43	7.943	8.827	7.919
22:30:00	1.900	113.0000	205.77	207.28	205.74	7.143	8.949	7.971
23:00:00	2.642	114.3300	206.72	206.22	206.61	8.678	11.767	10.513
23:30:00	2.686	115.7720	206.99	206.42	206.78	10.924	12.691	11.420
24:00:00	2.981	117.2040	207.64	207.49	207.49	11.499	14.949	11.499
Total			206.65	206.18	206.59	10.182	11.785	10.724
Average	2.842	117.2040	206.65	206.18	206.59	10.182	11.785	10.724
Maximum demand	5.327	117.2040	206.28	206.83	206.59	18.356	20.610	18.650
Time of maximum demand	2014/09/13 14:30:00	2014/09/13 24:00:00	2014/09/13 04:30:00	2014/09/13 08:00:00	2014/09/13 08:00:00	2014/09/13 14:30:00	2014/09/13 14:30:00	2014/09/13 14:30:00
Load factor	%							
Demand factor	%	53.27						
Facility capacity	[kW]	10.000						

Example data format

Choose from four display formats

Form

Display data for a user-specified interval as a summary form.

Daily report

Tabulate data by demand time and display a form summarizing a one-day period.

Weekly report

Tabulate data by day and display a form summarizing a one-week period.

Monthly report

Tabulate data by day and display a form summarizing a one-month period.

Check average and maximum values as well as the time at which the maximum value occurred

(Maximum values for daily, weekly, and monthly reports indicate maximum values as tabulated by demand time.)

When demand power is selected, the following quantities are calculated:

Load rate and demand rate

Weekly report

Time	Pdem+[kW]	WP+[kWh]	U1[V]	U2[V]	U12[V]	I1[A]	I2[A]	I12[A]
00:00:00 - 24:00:00	2.842	117.2040	206.65	206.18	206.59	10.182	11.785	10.724
00:00:00 - 24:00:00	2.958	188.1510	206.56	207.88	206.57	10.778	12.501	11.240
2014/09/16 00:00:00 - 24:00:00	3.490	260.5580	206.28	207.77	206.25	10.978	12.828	11.609
2014/09/17 00:00:00 - 24:00:00	3.724	349.8250	206.21	207.66	205.85	12.241	14.207	13.293
2014/09/18 00:00:00 - 24:00:00	3.076	423.7440	206.27	207.52	205.92	10.600	12.411	11.491
2014/09/19 00:00:00 - 24:00:00	2.683	487.6580	206.70	207.96	206.40	9.213	10.720	9.882
2014/09/16 - 2014/09/19	2.981	518.3920	206.22	207.81	206.20	10.445	12.183	11.189
Total	2.980	518.3920	206.49	207.88	206.30	10.445	12.183	11.189
Average	2.980	518.3920	206.49	207.88	206.30	10.445	12.183	11.189
Maximum demand	5.327	518.3920	206.28	206.83	206.59	18.356	20.610	18.650
Time of maximum demand	2014/09/14 12:30:00	2014/09/14 13:00:00	2014/09/14 04:30:00	2014/09/14 04:30:00	2014/09/14 08:00:00	2014/09/14 12:30:00	2014/09/14 12:30:00	2014/09/14 12:30:00
Load factor	%	52.75						
Demand factor	%	56.67						
Facility capacity	[kW]	10.000						

Date	Time	Pdem+[kW]	WP+[kWh]
	Average	2.990	
	Maximum demand	5.667	518.3920
	Time of maximum demand	2014/09/14 12:30:00	2014/09/14 13:00:00
	Load factor	%	52.75
	Demand factor	%	56.67
	Facility capacity	[kW]	10.000

WP+ [kWh]: Active energy

Active energy (consumption) from the start of recording

Pdem+ [kW]: Active power demand value

Average active power value (consumption) for each interval

Display harmonics and waveform data, convert to CSV format, and save screenshots

Configure the PW3365's recording settings to save harmonic data and display harmonics using the SF1001.

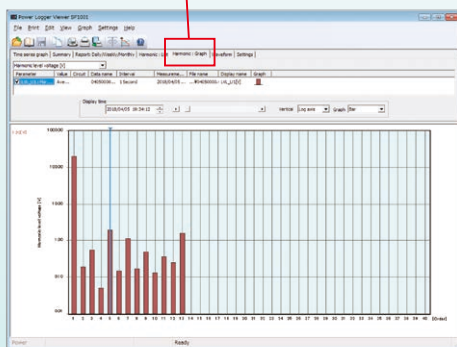

Configure the PW3365's settings to save waveforms and display them using the SF1001.

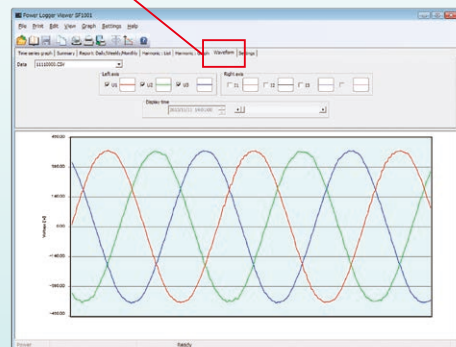

Convert binary data and save as a CSV file.

Binary format

- Harmonic data
- Waveform data

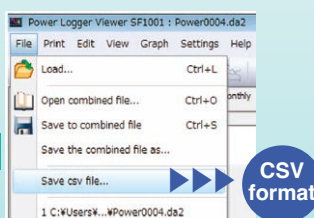

Save screen shots and paste into other software or print.

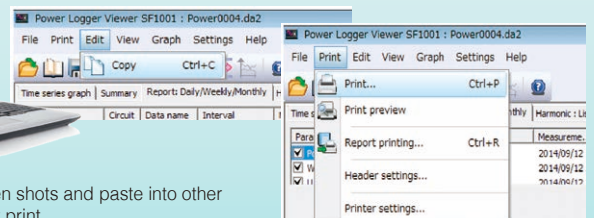

PW3365-20 Specifications

No dirt or moisture on insulated wire or voltage sensor,
(Accuracy guaranteed for 1 year)

Measurement		
Number of input channels	Voltage: 3 channels / Current: 3 channels	
Measurement targets (50/60Hz)	Single-phase 2-wire (1P2W, 1P2W × 2 circuits, 1P2W × 3 circuits) Single-phase 3-wire (1P3W, 1P3W+I, 1P3W1U, 1P3W1U+I) Three-phase 3-wire (3P3W2M, 3P3W2M+I, 3P3W3M/Y-wiring only) Three-phase 4-wire (3P4W), Current only: 1 to 3 channels	
Simultaneous power/current measurement modes	1P3W+I : 1 power circuit and 1 current channel 3P3W2M+I : 1 power circuit and 1 current channel	
Measurement items	Voltage	RMS value, fundamental wave value, waveform peak (absolute value), fundamental wave phase angle, frequency (U1)
	Current	RMS value, fundamental wave value, waveform peak (absolute value), fundamental wave phase angle
	Power	Active power, reactive power, apparent power, power factor, (with lag/lead display) or displacement power factor (with lag/lead display), active energy (consumption, regeneration, regeneration), reactive energy(lag, lead) Energy cost display (per-kWh price × power consumption)
	Demand	Active power demand value (consumption, regeneration), reactive power demand value (lag, lead), active power demand quantity (consumption, regeneration), reactive power demand quantity (lag, lead), power factor demand value
Harmonics	Harmonic voltage, harmonic current, voltage total harmonic distortion (THD-F or THD-R), current total harmonic distortion (THD-F or THD-R)	
Voltage range	Display range: 5 V to 520 V (less than 5 V displays as 0 V) (harmonic voltage value of 0 indicated for all orders when voltage RMS value is 0) Effective measurement range: 90 V rms to 520 V rms, peak: ±750 V peak [OVER] indicates over-range warning	
Current ranges	Load current	CLAMP ON SENSOR 9660 : 5/10/50/100 A
		CLAMP ON SENSOR 9661 : 5/10/50/100/500 A
		CLAMP ON SENSOR 9669 : 100/200/1 kA
		CLAMP ON SENSOR 9694 : 500m/1/5/10/50 A
	Leakage current	CLAMP ON SENSOR 9695-02 : 500m/1/5/10/50 A
		CLAMP ON SENSOR 9695-03 : 5/10/50/100 A
		AC FLEXIBLE CURRENT SENSOR CT9667-01, -02, -03 : 50/100/500 A (500A range)
		AC FLEXIBLE CURRENT SENSOR CT9667-01, -02, -03 : 500/1k/5 k A (5000A range)
Power ranges	LEAK CLAMP ON SENSOR 9675 : 50 m/100 m/500 m/1/5 A	
	LEAK CLAMP ON SENSOR 9657-10 : 50 m/100 m/500 m/1/5 A	
	Total display range: Within 0.4 to 130% of the range (zero is suppressed for less than 0.4%) (harmonic current value of 0 indicated for all orders when current RMS value is 0) Effective measurement range: Within 5 to 110% of the range [OVER] indicates over-range warning	
Measurement accuracy (50/60Hz)	200.00 W to 6.0000 MW Depends on voltage/current combination and measured line type (see Measurement Range Configuration Tables) Total display range: Within 0 to 130% of the range (“0W” display indicates zero rms voltage and/or current) Effective measurement area: Within 5 to 130% of the range	
	Voltage : ±1.5% rdg. ±0.8 V (combined accuracy with PW3365-20 + PW9020) Current : ±0.3% rdg. ±0.1% f.s. + clamp sensor accuracy Active power : ±2.0% rdg. ±0.3% f.s. + clamp sensor accuracy (power factor = 1)	
	Calculations	RMS calculation/ fundamental wave calculation
VT ratio settings	Any 0.01 to 9999.99 Selections 1/60/100/200/300/600/700/1000/2000/2500/5000	
CT ratio settings	Any 0.01 to 9999.99 Selections 1/40/60/80/120/160/200/240/300/400/600/800/1200	
Input methods	Voltage: Isolated inputs using Voltage Sensor PW9020 Current: Isolated input using a clamp-on sensor	
Display update rate	Approx. 0.5 sec (except when accessing SD card or internal memory, or during LAN/USB communication)	
Measurement method	Digital sampling and zero cross synchronization calculation method Sampling: 10.24 kHz (2048 points) Calculation processing 50 Hz: Continuous, gapless measurement at 10 cycles 60 Hz: Continuous, gapless measurement at 12 cycles	

*1 For individual clamp sensors' accuracy and combined accuracy figures, see pages 14 and 15.

Harmonic Specifications	
Standard	IEC 61000-4-7:2002 (but without harmonics for intermediate orders)
Window width	50 Hz: 10 cycles; 60 Hz: 12 cycles (with interpolation)
Analyzed orders	Up to 13th order
Analysis parameters	Harmonic levels: Voltage and current harmonic level for each order (With 3P3W2M connection, U12 and I12, which are calculated as part of third channel computations, are not displayed.) Harmonic content percentages: Voltage and current content percentages for each order; total harmonic distortion: voltage and current (THD-F or THD-R)
Measurement accuracy	Harmonic level Voltage PW3365 alone: ±5% rdg. ±0.2% f.s. Combined accuracy for PW3365 and PW9020: ±30% rdg. ±3% f.s. (input for each order up to 5% of the fundamental wave, THD-F up to 10%) Current ±5% rdg. ±0.2% f.s. + sensor accuracy Total harmonic distortion: Accuracy not defined

Screen Display	
List	Voltage, current, frequency, active/apparent/reactive power power factor, integrated power use, elapsed time
U/I	RMS value, fundamental wave value, waveform peak, phase angle
Power	Per-channel and total active power, apparent power, reactive power, power factor
Integ	Active energy, reactive energy, recording start time recording stop time, elapsed time, energy cost
Demand	Active power demand value, reactive power demand value power factor demand value
Waveform	Displays voltage and current waveform
Zoom	Enlarged view of 4 user-selected parameters
Trend	For one selected measurement item (not including harmonics other than demand and THD) displays maximum, average and minimum values
Harmonics	Displays voltage and current levels and content percentages as a graph or list

Recording	
Save destination	SD Card, internal memory (capacity: approx. 320 KB)
Save interval time	1/2/5/10/15/30 seconds, 1/2/5/10/15/20/30/60 minutes Available storage time is displayed on the PW3365-20's setting screen
Save items	Measurement save : Average only/all (without harmonics) Average only/all (with harmonics) Screen save : Saves the displayed screen as a BMP at a fixed interval* ¹ Waveform save : Stores binary waveform data* ²
Recording start methods	Interval time, manual, or at specified time, repeat
Recording stop methods	Manual, or at specified time (up to one year), timer

*¹ The minimum interval time for saving screen copies is 5 min. If the setting is less than 5 min., screen copies will be saved every 5 min.

*² With shortest interval of 1 minute. When set to less than 1 minute, waveforms are saved once every minute

External Interfaces	
SD card	Settings data, measurement data, screen data, waveform data
LAN	100BASE-TX IEEE802.3 Compliance - HTTP server function, FTP server function
USB	USB Ver 2.0, Windows 10 (32/64bit)/Windows 8 (32/64bit)/ Windows 7 (32/64bit) - When connected to a computer, the SD Card and internal memory are recognized as removable storage devices.

General	
Product guarantee	3 year
Display	3.5 inch TFT color LCD (320 × 240 pixel)
	Japanese, English, Chinese, Korean, German, Italian, French, Spanish, Turkish Backlight auto-off function (after 2 minutes) When AUTO OFF is active, the Power LED blinks
Operating environment	Indoors, Pollution degree 2, altitude up to 2000 m (6562-ft.)
Operating temperature and humidity (no condensation)	-10°C to 50°C (14°F to 122°F), 80% RH or less During battery operation: 0°C to 40°C (32°F to 104°F), 80% RH or less During battery charging: 10°C to 40°C (50°F to 104°F), 80% RH or less
Storage temperature and humidity (no condensation)	0°C to 60°C (32°F to 140°F), 80% RH or less However, the battery's storage temperature range is -10°C to 30°C (14°F to 86°F)
Maximum rated voltage between terminals	Voltage input section : 1.7 VAC, 2.4 Vpeak Current input section : 1.7 VAC, 2.4 Vpeak
Maximum rated voltage to earth	Voltage input section: 600V Measurement Category III 300V Measurement Category IV Current input section: Depends on clamp sensor in use.
Dielectric strength	7.06 kVrms AC
Applicable standards	Safety: EN61010, EMC: EN61326
Power supply	(1) Z1008 AC Adapter : 100 V AC to 240 V AC Maximum rated power : 45 VA (including AC adapter) (2) Model 9459 Battery Pack : Ni-MH DC7.2 V 2700 mAh Continuous battery operation time Approx. 3 hr. Maximum rated power : 5 VA
Charge function	Charge time: Max. 6 hr. 10 min. (reference value at 23°C) Charges the battery regardless of whether the instrument is on or off
Backup battery life	Clock and settings (Lithium battery), Approx. 10 years @23°C (@73.4°F)
Dimensions	Approx. 180W(7.09") × 100H(3.94") × 48D (1.89") mm (without PW9002)
	Approx. 180W(7.09") × 100H(3.94") × 68D (2.68") mm (with PW9002)
Mass	Approx. 540g (19 oz) (without PW9002), Approx. 820g (28.9 oz) (with PW9002)
Accessories	SAFETY VOLTAGE SENSOR PW9020 (4) AC ADAPTER Z1008 (1) USB cable (1) Instruction manual (1) Measurement guide (1) Red, yellow, blue and white color clips (4 each) Spiral tubes (10)

POWER LOGGER VIEWER SF1001 Specifications

Functions	
Trend graph display function	Display items Voltage, current, active power, reactive power, apparent power, power factor, frequency, integrated active power, integrated reactive power, demand volume, demand value, voltage disequilibrium factor
	Stacked bar graph display : Up to 16 types of data series
Summary display function	Cursor measurements Measurement values can be displayed by the cursor
	Displayed items are the same as for the trend Graph Display
	Daily, weekly and monthly report displays: Accumulates and displays daily, weekly and monthly reports over specified period.
	Load factor calculation display: Calculates and displays load factor and demand factor results with daily, weekly and monthly reports
Waveform display	Time span aggregation: Aggregates data into up to four specified time spans
Waveform display	Displays waveform data at specified date and time
Copy function	Captures any display image to the clipboard

Print function	Preview and print content shown on the trend graph, report, harmonic graph and settings displays.
	Comment entry (Text comments can be entered in any printout)
	Header/Footer settings: Sets the header and footer for each printout
Report printing	Printing support Any color or monochrome printing supported by the operating system
	Print (static) contents over a specific time period
	Output contents: Standard or selected output items
	Available output items: Trend graph, summary, daily report, waveform Report creation method: Standard print Report output settings: Save/load report output settings

General Specifications	
Supported models	PW3365-20 / PW3360-20 / PW3360-21 LR5000 series ; Data previously loaded by the LR5000 Utility (.hnp2 format) using a PC
Supported computer operating systems	Windows 10 (32/64bit) Windows 8 (32/64bit) Windows 7 SP1 or later (32/64bit)

Current CLAMP

					
CLAMP ON SENSOR 9694	CLAMP ON SENSOR 9660	CLAMP ON SENSOR 9661	CLAMP ON SENSOR 9669	CLAMP ON SENSOR 9695-02	CLAMP ON SENSOR 9695-03
Cord length 3 m (9.84ft)	Cord length 3 m (9.84ft)	Cord length 3 m (9.84ft)	Cord length 3 m (9.84ft)	Connect with the 9695-02/-03, Output BNC terminal Cord length: 3 m (9.84ft)	CONNECTION CORD 9219
Measurable conductor diameter φ15 mm (0.59")	Measurable conductor diameter φ15 mm (0.59")	Measurable conductor diameter φ46 mm (0.81")	Measurable conductor diameter φ55 mm (2.17") 80 (3.15")×20 (0.79") mm	Measurable conductor diameter φ15 mm (0.59")	Measurable conductor diameter φ15 mm (0.59")
Primary current rating 5 A AC	Primary current rating 100 A AC	Primary current rating 500 A AC	Primary current rating 1000 A AC	Primary current rating 50 A AC	Primary current rating 100 A AC
Accuracy Amplitude (45 to 66 Hz) / Phase (45 Hz to 5 kHz) ±0.3% rdg.±0.02% f.s. Within ±2°	Accuracy Amplitude (45 to 66 Hz) / Phase (45 Hz to 5 kHz) ±0.3% rdg.±0.02% f.s. Within ±1°	Accuracy Amplitude (45 to 66 Hz) / Phase (45 Hz to 5 kHz) ±0.3% rdg.±0.01% f.s. Within ±0.5°	Accuracy Amplitude (45 to 66 Hz) / Phase (45 Hz to 5 kHz) ±1.0% rdg.±0.01% f.s. Within ±1°	Accuracy Amplitude (45 to 66 Hz) / Phase (45 Hz to 5 kHz) ±0.3% rdg.±0.02% f.s. Within ±2°	Accuracy Amplitude (45 to 66 Hz) / Phase (45 Hz to 5 kHz) ±0.3% rdg.±0.02% f.s. Within ±1°
Frequency characteristic 40Hz to 5kHz Within ±1.0%	Frequency characteristic 40Hz to 5kHz Within ±1.0%	Frequency characteristic 40Hz to 5kHz Within ±1.0%	Frequency characteristic 40Hz to 5kHz Within ±2.0%	Frequency characteristic 40Hz to 5kHz Within ±1.0%	Frequency characteristic 40Hz to 5kHz Within ±1.0%
Effect of external magnetic field with a magnetic field of 400 A/ m AC Equivalent to 0.1 A or less	Effect of external magnetic field with a magnetic field of 400 A/ m AC Equivalent to 0.1 A or less	Effect of external magnetic field with a magnetic field of 400 A/ m AC Equivalent to 0.1 A or less	Effect of external magnetic field with a magnetic field of 400 A/ m AC Equivalent to 1 A or less	Effect of external magnetic field with a magnetic field of 400 A/ m AC Equivalent to 0.1 A or less	Effect of external magnetic field with a magnetic field of 400 A/ m AC Equivalent to 0.1 A or less
Effect of conductor position Within ±0.5%	Effect of conductor position Within ±0.5%	Effect of conductor position Within ±0.5%	Effect of conductor position Within ±1.5%	Effect of conductor position Within ±0.5%	Effect of conductor position Within ±0.5%
Maximum rated voltage to earth CAT III 300 V rms	Maximum rated voltage to earth CAT III 300 V rms	Maximum rated voltage to earth CAT III 600 V rms	Maximum rated voltage to earth CAT III 600 V rms	Maximum rated voltage to earth CAT III 300 V rms	Maximum rated voltage to earth CAT III 300 V rms
Maximum input 45-66 Hz 50 A continuous	Maximum input 45-66 Hz 130 A continuous	Maximum input 45-66 Hz 550 A continuous	Maximum input 45-66 Hz 1000 A continuous	Maximum input 45-66 Hz 60 A continuous	Maximum input 45-66 Hz 130 A continuous
Dimensions / Mass 46W × 135H × 21D mm / 230 g (1.81") × (5.31") × (0.83") / (8.1 oz)	Dimensions / Mass 46W × 135H × 21D mm / 230 g (1.81") × (5.31") × (0.83") / (8.1 oz)	Dimensions / Mass 77W × 151H × 42D mm / 380 g (3.03") × (5.94") × (1.65") / (13.4 oz)	Dimensions / Mass 99.5W × 188H × 42D mm / 590 g (3.92") × (7.40") × (1.65") / (20.8 oz)	Dimensions / Mass 50.5W × 58H × 18.7D mm / 50 g (2.28") × (2.28") × (0.74") / (1.8 oz)	Dimensions / Mass 50.5W × 58H × 18.7D mm / 50 g (2.28") × (2.28") × (0.74") / (1.8 oz)
					
CT9667-01	CT9667-02	CT9667-03	CLAMP ON LEAK SENSOR 9657-10	CLAMP ON LEAK SENSOR 9675	
AC FLEXIBLE CURRENT SENSOR			Leakage Current Measurement Only	Leakage Current Measurement Only	
Cord length : Sensor - circuit: 2 m (6.56ft) , Circuit - connector: 1 m (3.28ft)			Cord length : 3 m (9.84ft)	Cord length : 3 m (9.84ft)	
Measurable conductor diameter	CT9667-01 : φ100 mm, CT9667-02 : φ180 mm CT9667-03 : φ254 mm		Measurable conductor diameter φ40 mm	Measurable conductor diameter φ30 mm	
Primary current rating	AC500 A/ AC5000 A (Switchable)		Primary current rating AC 10 A *	Primary current rating AC 10 A *	
Accuracy 45-66Hz	±2.0% rdg ± 0.3% f.s. / Within ±1°		Accuracy ±1.0% rdg ±0.05% f.s. / Within ±3°	Accuracy ±1.0% rdg ±0.05% f.s. / Within ±5°	
Frequency 10-20kHz	Within ± 3dB		Frequency 40 - 5kHz	Within ± 5%	
Effect of external magnetic field	2.4% f.s. or less		Effect of external magnetic field	7.5 mA max.	
Effect of conductor position	Within ± 3%		Effect of conductor position	Within ±0.1%	
Maximum rated voltage to earth	CAT III 1000 V rms / CAT IV 600 V rms		Measurable conductor	Insulated conductor	
Maximum input 45-66Hz	10000 A continuous		Maximum input 45-66Hz	30A continuous	
Dimensions / Mass	Circuit box: 35W × 120.5H × 34D CT9667-01, -02 : 280 g, CT9667-03 : 470 g		Dimensions / Mass	74W × 145H × 42D / 380g	
Power supply	LR06 alkaline battery × 2 or AC ADAPTER 9445-02/9445-03 (optional)		Notes	Not used for power measurements *Maximum AC measurement range with PW3365-20 is 5 A	
				Not used for power measurements *Maximum AC measurement range with PW3365-20 is 5 A	

Measurement Range Configurations

CLAMP ON SENSOR 9694 / 9695-02 *1						
Voltage	Connection	Current				
		500.00 mA	1.0000 A	5.0000 A	10.000 A	50.000 A
400.0 V	1P2W	200.00 W	400.00 W	2.0000 kW	4.0000 kW	20.000 kW
	1P3W 1P3W1U 3P3W2M 3P3W3M	400.00 W	800.00 W	4.0000 kW	8.0000 kW	40.000 kW
	3P4W	600.00 W	1.2000 kW	6.0000 kW	12.000 kW	60.000 kW

CLAMP ON SENSOR 9660 / 9695-03 / 9661 *2						
Voltage	Connection	Current				
		5.0000 A	10.000 A	50.000 A	100.00 A	9661 only 500.00 A
400.0 V	1P2W	2.0000 kW	4.0000 kW	20.000 kW	40.000 kW	200.00 kW
	1P3W 1P3W1U 3P3W2M 3P3W3M	4.0000 kW	8.0000 kW	40.000 kW	80.000 kW	400.00 kW
	3P4W	6.0000 kW	12.000 kW	60.000 kW	120.00 kW	600.00 kW

CLAMP ON SENSOR 9669				
Voltage	Connection	Current		
		100.00 A	200.00 A	1.0000 kA
400.0 V	1P2W	40.000 kW	80.000 kW	400.00 kW
	1P3W 1P3W1U 3P3W2M 3P3W3M	80.000 kW	160.00 kW	800.00 kW
	3P4W	120.00 kW	240.00 kW	1.2000 MW

AC FLEXIBLE CURRENT SENSOR CT9667-01, -02, -03 (5 kA)				
Voltage	Connection	Current		
		500.00 A	1.0000 kA	5.0000 kA
400.0 V	1P2W	200.00 kW	400.00 kW	2.0000 MW
	1P3W 1P3W1U 3P3W2M 3P3W3M	400.00 kW	800.00 kW	4.0000 MW
	3P4W	600.00 kW	1.2000 MW	6.0000 MW

AC FLEXIBLE CURRENT SENSOR CT9667-01, -02, -03 (500 A)				
Voltage	Connection	Current		
		50.00 A	100.00 A	500.00 A
400.0 V	1P2W	20.000 kW	40.000 kW	200.00 kW
	1P3W 1P3W1U 3P3W2M 3P3W3M	40.000 kW	80.000 kW	400.00 kW
	3P4W	60.000 kW	120.00 kW	600.00 kW

Leak current: CLAMP ON LEAK SENSOR 9657-10, 9675	
Range	50.000 mA/ 100.00 mA/ 500.00 mA/ 1.0000 A/ 5.0000 A

Combined Accuracy PW3365-20 + PW9020 + clamp sensors

Range	9694	9695-02
50.000 A	-	±2.3% rdg. ±0.32% f.s.
10.000 A	-	±2.3% rdg. ±0.4% f.s.
5.0000 A	±2.3% rdg. ±0.32% f.s.	±2.3% rdg. ±0.5% f.s.
1.0000 A	±2.3% rdg. ±0.4% f.s.	±2.3% rdg. ±1.3% f.s.
500.00 mA	±2.3% rdg. ±0.5% f.s.	±2.3% rdg. ±2.3% f.s.

Range	9660, 9695-03	9661
500.00 A	-	±2.3% rdg. ±0.31% f.s.
100.00 A	±2.3% rdg. ±0.32% f.s.	±2.3% rdg. ±0.35% f.s.
50.000 A	±2.3% rdg. ±0.34% f.s.	±2.3% rdg. ±0.4% f.s.
10.000 A	±2.3% rdg. ±0.5% f.s.	±2.3% rdg. ±0.8% f.s.
5.0000 A	±2.3% rdg. ±0.7% f.s.	±2.3% rdg. ±1.3% f.s.

Range	9669
1.0000 kA	±3% rdg. ±0.31% f.s.
200.00 A	±3% rdg. ±0.35% f.s.
100.00 A	±3% rdg. ±0.4% f.s.

Range	CT9667-01, -02, -03 5.000kA range	CT9667-01, -02, -03 500A range
5.0000 kA	±4% rdg. ±0.6% f.s.	-
1.0000 kA	±4% rdg. ±1.8% f.s.	-
500.00 A	±4% rdg. ±3.3% f.s.	±4% rdg. ±0.6% f.s.
100.00 A	-	±4% rdg. ±1.8% f.s.
50.000 A	-	±4% rdg. ±3.3% f.s.

Conditions of guaranteed accuracy: After 30 minute warm-up, with 50/60 Hz sine wave input voltage to earth 400V or less

Temperature and humidity for guaranteed accuracy: 23°C ±5°C (73 ± 9°F), 80%RH or less (applies to all specifications unless otherwise noted)

Display area of guaranteed accuracy: Effective measurement range

Real-time clock accuracy: Within ±0.3 sec/day (with power on, within specified operating temperature and humidity ranges)

Temperature characteristic: Within ±0.1% f.s./ °C (except 23±5°C)

Effect of external magnetic field: Within ±1.5% f.s. (in a magnetic field of 400 A/m rms AC, 50 Hz/60 Hz)

Effect of radiated, radio-frequency, electromagnetic field: Within ±5% f.s. for voltage and active power at 10 V/m

Apparent power: ±1 dgt. for the calculation obtained from each measurement value

Reactive power: Fundamental waveform calculations ±2.0% rdg. ±3.0% f.s. + clamp-on sensor accuracy (w/power factor = 1)

Rms calculations: From each measurement applied to calculation ±1 dgt.

Energy: Active and reactive power measurement accuracies ±1 dgt.

Power factor: From each measurement applied to calculation ±1 dgt.

Frequency: ±0.5% rdg. (with 90 to 520 V sine wave input)

Demand value: Active and reactive power measurement accuracies ±1 dgt.

Demand quantity: Active and reactive power measurement accuracies ±1 dgt.

*1 For the 9694 sensor, the range of guaranteed accuracy is from 500 mA to 5 A, and for the 9695-02, from 500 mA to 50 A.

*2 For the 9660 and 9695-03 sensors, the range of guaranteed accuracy is from 5 A to 100 A and for the 9661, from 5 A to 500 A.

Current Display and Effective Measurement Ranges

typical

	Range	Total display range	Effective measurement range		Total display range	Effective peak
		Minimum	Minimum	Maximum	Maximum	Range
Voltage	400 V Range	5.0 V	90.0 V	520.0 V	520.0 V	±750 V peak
Current	5 A Range	0.0200 A	0.2500 A	5.5000 A	6.5000 A	±20 A peak
	10 A Range	0.040 A	0.500 A	11.000 A	13.000 A	±40 A peak
	50 A Range	0.200 A	2.500 A	55.000 A	65.000 A	±200 A peak
	100 A Range	0.40 A	5.00 A	110.00 A	130.00 A	±400 A peak
	500 A Range	2.00 A	25.00 A	550.00 A	650.00 A	±1000 A peak



Accessories

- SAFETY VOLTAGE SENSOR PW9020 x4
- AC ADAPTER Z1008 x1
- USB cable (0.9 m, 2.95 ft length) x1
- Instruction manual x1
- Measurement guide x1
- Color clips (red, green, yellow, white) 4 each
- Spiral tubes x10



Model : CLAMP ON POWER LOGGER PW3365

Model No. (Order Code) (Note)

PW3365-20 (English model, main unit only)

Clamp On Power Logger PW3365-20 by itself does not support current and power measurements. Current and power measurements require clamp on sensors, sold separately. Use only HIOKI SD cards guaranteed to work for saving measurement data (options, sold separately).

Options

CLAMP ON SENSOR (for load current measurement)

CLAMP ON SENSOR	9694	(AC 5 A)
CLAMP ON SENSOR	9660	(AC 100 A)
CLAMP ON SENSOR	9661	(AC 500 A)
CLAMP ON SENSOR	9669	(AC 1000 A)
AC FLEXIBLE CURRENT SENSOR	CT9667-01	(AC 500 A / 5000 A)
AC FLEXIBLE CURRENT SENSOR	CT9667-02	(AC 500 A / 5000 A)
AC FLEXIBLE CURRENT SENSOR	CT9667-03	(AC 500 A / 5000 A)
CLAMP ON SENSOR (Not CE marked) *	9695-02	(AC 50 A)
CLAMP ON SENSOR (Not CE marked) *	9695-03	(AC 100 A)
CONNECTION CORD	9219	(for connection to 9695-02, 9695-03)

* When purchasing the 9695-02 and 9695-03, we recommend also purchasing the separately sold 9219 Connection Cord.

CLAMP ON LEAK SENSOR (for leakage current measurement)

CLAMP ON LEAK SENSOR	9657-10
CLAMP ON LEAK SENSOR	9675

CLAMP ON ADAPTER 9290-10

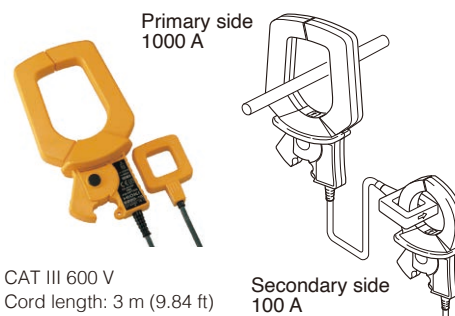

Measurable conductor diameter

φ55 mm (2.17 in)
Bus bar : 80 mm (3.46in) 5 20 mm (0.79 in)
CT ratio : 10:1
MAX. 1500 A AC (continuous: 1000 A)

POWER LOGGER VIEWER SF1001

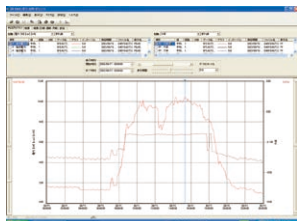

Supported computer operating systems

Trend graph display function
Summary display function
Waveform display, Print function
Report printing

BATTERY SET PW9002



Battery Case and Battery Pack Set

BATTERY PACK 9459

For purchase as replacement battery pack

SAFETY VOLTAGE SENSOR PW9020



PW3365-20 is bundled with 4 sensors
Additional single sensors also available
Cord length: 3 m (9.84 ft)

CARRYING CASE C1005/C1008



The photo shows C1008.

	C1005	C1008
Dimension : 390W (15.4") (Approx)	275H (10.8")	275H (10.8")
	110D (4.3") mm	150D (5.9") mm

AC ADAPTER Z1008



Includes standard
For separate purchase

SD MEMORY CARD Z4003



8 GB capacity

Stores up to one year's data when acquired at one minute intervals. Performance cannot be guaranteed on storage media other than Hioki-specified SD card options.

SD MEMORY CARD 2GB Z4001



2 GB capacity

LAN CABLE 9642



Straight Ethernet cable, supplied with straight to cross conversion adapter, 5 m (16.41 ft) length

Note: Company names and product names appearing in this catalog are trademarks or registered trademarks of various companies.

HIOKI

HIOKI E. E. CORPORATION

HEADQUARTERS

81 Koizumi,
Ueda, Nagano 386-1192 Japan
<https://www.hioki.com/>



Scan for all regional contact information

DISTRIBUTED BY