

CT6846A

AC/DC CURRENT PROBE

Maximum rating 1000 A, high-stability, high-accuracy, high-CMRR, high-performance fluxgate technology, clamp type



Features

- $\pm 0.2\%$ rdg. Accuracy
- 20 ppm linearity
- Frequency band DC to 100 kHz
- Guaranteed Accuracy Temperature Range -40°C to 85°C
- Voltage output
- No warm-up required
- Measurable aperture $\phi 50$ mm
- The Power Analyzer PW8001, PW4001 or the Data Logger LR8101, LR8102 with the Power Measurement Module M7103 automatically recognizes the current sensor's information (phase shift data, sensor model name, rated current, serial number) when connected.

Applications

- Automotive (WLTP, SAE J1634, energy flow, ADAS and EVSE calibration)
- Battery SOC
- Renewable energy (PV, PCS manufacturing and calibration)
- Efficiency of high-efficiency energy converters
- Industrial drones
- Data center consumption current

Specification highlights	Symbol	Unit	Min.	Typ.	Max.
Nominal primary DC current	$I_{PN\ DC}$	A	-1000		1000
Nominal primary AC current	$I_{PN\ AC}$	Arms			1000
Measurement range	I_{PM}	A	-1100		1100
Nominal output voltage	V_{out}	V	-2		2
Primary/secondary ratio	Ratio	mV/A	2	2	2
Linearity error	ϵ_L	ppm		± 20	
Bandwidth ($\pm 3\text{dB}$)	f	kHz		100	
Withstand voltage (1 mA, 50/60 Hz for 1 minute)	U_d	kV			4.26
Power supply voltage	U_c	V	± 11.5		± 15
Operating temperature range	T_A	$^{\circ}\text{C}$	-40		85
Output cable length	L_{cable}	m		3	

CT6846A

AC/DC CURRENT PROBE

Electrical specifications at TA = 23°C ±5°C, supply voltage (by using external PSU) = ±12 V unless otherwise stated

Parameter	Symbol	Unit	Min.	Typ.	Max.	comment
Nominal primary DC current	I _{PN DC}	A	-1000		1000	Refer to "Figure 1. Frequency derating"
Nominal primary AC current	I _{PN AC}	A rms			1000	Refer to "Figure 1. Frequency derating"
Measuring range	I _{PM}	A	-1100		1100	Refer to "Figure 1. Frequency derating"
Maximum input current	I _{MAX}	A peak	-1900		1900	Not exceeding derating curve shown in Figure 1 However, it is allowable for up to 20 ms at 40°C or less
Nominal output voltage	V _{out}	V	-2		2	
Primary / secondary ratio	Ratio	mV/A	2	2	2	
Bandwidth (-3dB)	f	kHz		100		Refer to "Figure 2. Frequency characteristics"
Output resistance		Ω	40	50	60	
Linearity error	ε _L	ppm		±20		
Offset adjustment range		mV	-2		2	
Output noise	noise	mV rms			600	Measurement bandwidth: DC to 1 MHz
Effects of temperature Amplitude sensitivity Offset voltage		% of reading/°C % of full scale/°C	-0.01 -0.005		0.01 0.005	Within the range of -40°C to 0°C or 40°C to 85°C
Effects of magnetization		mA			150	Input equivalent, after 1000 A DC is inputted
Common mode voltage rejection ratio DC to 1 kHz 1 kHz to 10 kHz 10 kHz to 50 kHz	CMRR	dB	150 130 100			Effect on output voltage/common-mode voltage
Effects of conductor position DC to 100 Hz		% of reading			0.2	For a conductor with an outer diameter of 10 mm
Effects of external magnetic field		mA			150	Input equivalent, under a magnetic field of 400 A/m, DC or 60 Hz
Effects of radiated radio-frequency electromagnetic field		% of full scale		6		10 V/m
Effects of conducted radio-frequency electromagnetic field		% of full scale		6		10 V
Fluxgate excitation frequency	f _{Exc}	MHz		1.65		
Power supply voltages	U _c	V	±11.5		±15	
Positive current consumption	I _{ps}	mA			300	DC + 1000 A with ±12V
Negative current consumption	I _{ns}	mA			-300	DC - 1000 A with ±12V

Isolation specifications

Parameter	Unit	Value	Comment
Withstand voltage (AC/DC), between jaws and output terminal (when attached to line under measurement)	kV	4.26	Sensed current: 1 mA, 50/60 Hz, 1 minute
Standards			Safety: EN 61010 EMC: EN 61326

HIOKI E.E. CORPORATION

All information correct as of May 11, 2026. HIOKI E.E. CORPORATION
Company names and product names appearing in this catalog are trademarks or registered trademarks of various companies.
Written in Japan
All specifications are subject to change without notice.

CT6846A

AC/DC CURRENT PROBE

Environmental and mechanical characteristics

Parameter	Symbol	Unit	Min.	Typ.	Max.	Comment
Operating environment (altitude)		m			2000	Indoor use, pollution degree 2
Ambient operating temperature range	T _A	°C	-40		85	
Ambient storage temperature range	T _{Ast}	°C	-40		85	
Relative humidity	RH	%			80	Non-condensing
Measurable conductor diameter	D _{meas}	mm			50	
Dimensions	W H D	mm		238 116 35		
Output cable length	L _{cable}	m		3		
Weight	m	g		990		

Measurement accuracy (total accuracy including uncertainty in calibration system etc.)

Electrical specifications at T_A = 0°C to 40°C, supply voltage (by using external PSU) = ±12 V unless otherwise stated

Frequency [Hz]	Amplitude		Phase [°]
	[±% of reading]	[±% of full scale]	
DC	0.2	0.02	—
DC < f ≤ 100	0.2	0.01	±0.1°
100 < f ≤ 500	0.5	0.02	±0.2°
500 < f ≤ 1 k	1.0	0.02	±0.5°
1 k < f ≤ 5 k	2.0	0.02	±(0.7 × f)°
5 k < f ≤ 10 k	5.0	0.02	
10 k < f ≤ 50 k	30.0	0.02	
Frequency band	100 kHz (±3 dB, typical)		—

- Unit for f in the calculation formulas: kilohertz (kHz)
- DC accuracy is defined after the offset voltage has been regulated at ±0.2 mV or less.
- The amplitude and phase accuracy are defined for an input current not more than current of 110% of full scale and the derating curve (Fig. 1). However, the accuracy defined for the frequency range of DC < f < 10 Hz is the design values.
- Add ±0.03% of reading to the amplitude accuracy if an input current is within the range of 100% to 110% of full scale.

Definition of on accuracy (total accuracy including uncertainty in calibration system etc.)

Reading (displayed value) error: Indicates the value displayed by the instrument. Limit values for reading errors are expressed as a percentage of the reading (“% of reading” or “% rdg.”).

Range error: Indicates the instrument’s range. Limit values for range errors are expressed as a percentage of the range (“% of range”).

Full scale (rated current) error: Indicates the rated current. Limit values for full-scale errors are expressed as a percentage of full scale (“% of full scale” or “% f.s.”).

Calibration: The accuracy of HIOKI products includes all factors that affect the measurement results, such as calibration system errors, ambient temperature, and secular change, as “**uncertainty**”.

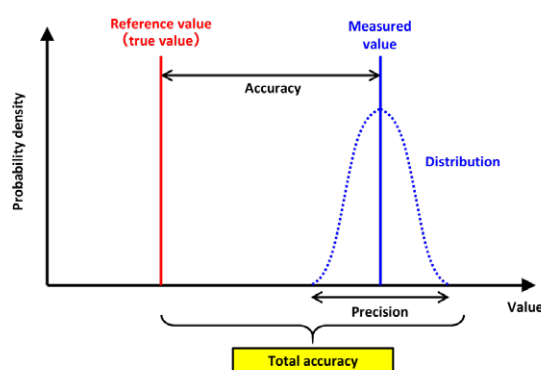





HIOKI is accredited as an official ISO/IEC 17025 calibrator.

CT6846A

AC/DC CURRENT PROBE

Specific accuracy calculation example

How to measure the current **DC 500 A** of a conductor with a diameter of ϕ 50 mm or less with high accuracy.
 Guaranteed specifications at TA = 0°C to 40°C

Measuring instrument configuration	CT6846A	CT9555	L9217 + 9704	DM7276
External view				
Range (connection)	1000 A (2000 mV)	Front OUTPUT terminal (BNC terminal)	✓	1000 mV
Output voltage	500 A × 2000 mV / 1000 A = 1000 mV			
Error (reading)	0.2%	—	—	0.0011%
Error (full scale)	0.02%	—	—	3 μV
Total error	$1000 \text{ mV} \times (0.2 + 0.0011) \% + 2000 \text{ mV} \times 0.02\% + (3 \mu\text{V} \times 10^{-3}) \text{ mV} = 2.414 \text{ mV}$			
Total error (input equivalent)	$2.414 \text{ mV} / 2000 \text{ mV} \times 1000\text{A} = 1.207 \text{ A}$			
Error range	$500 \text{ A} \pm 1.207 \text{ A} \rightarrow 498.793 \text{ A to } 501.207 \text{ A}$			

Definition of linearity error

Linearity error ϵ_L : Indicates that the output voltage changes linearly in response to the input current. A regression line is attained by measuring the output voltage in the sequence below in 200 A intervals:
 +1000 A → 0 A → -1000 A → 0 A → +1000 A
 It is defined as the difference between the regression line calculated from the

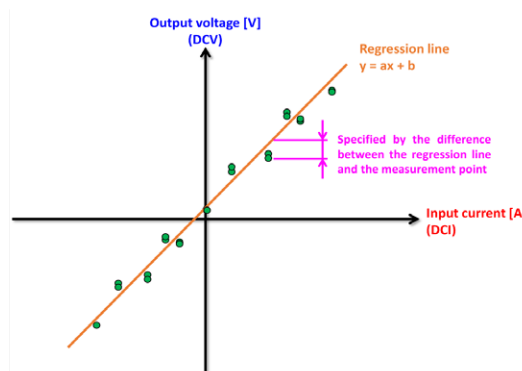

Definition of offset error

Offset error ϵ_o : Specified by the ratio of the average value (μ) of the measured values of the offset voltage and the rated current (I_{max}) of each current sensor.

$$\epsilon_o = \mu / I_{max} \text{ [ppm]}$$

Definition of amplitude error

Amplitude error ϵ_G : An index showing the degree of flatness of the frequency characteristics of gain.
 DC error is defined as "linearity error + offset error."
 AC error is defined as deviation from the 55 Hz measurement point.

$$\epsilon_{GDC} = \epsilon_L + \epsilon_o \text{ [ppm]}$$

$$\epsilon_{GAC} = \frac{\text{Gain} (f) - \text{Gain} (55 \text{ Hz})}{\text{Gain} (55 \text{ Hz})} \times 100 \text{ [%]}$$

CT6846A

AC/DC CURRENT PROBE

Figure 1. Frequency derating

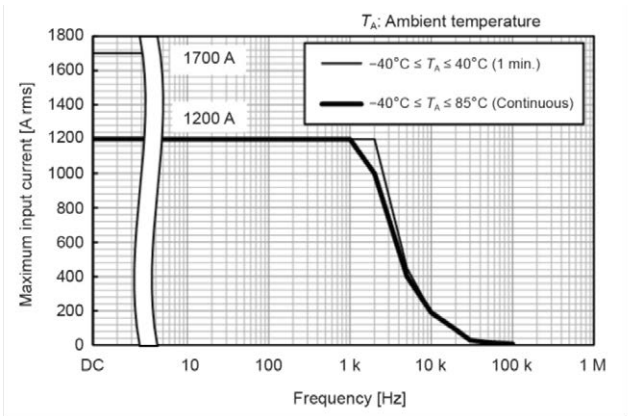

Defined when neither adjacent current nor external magnetic field exists, and the conductor is located at the center of the jaw aperture.

Figure 2. Frequency characteristics

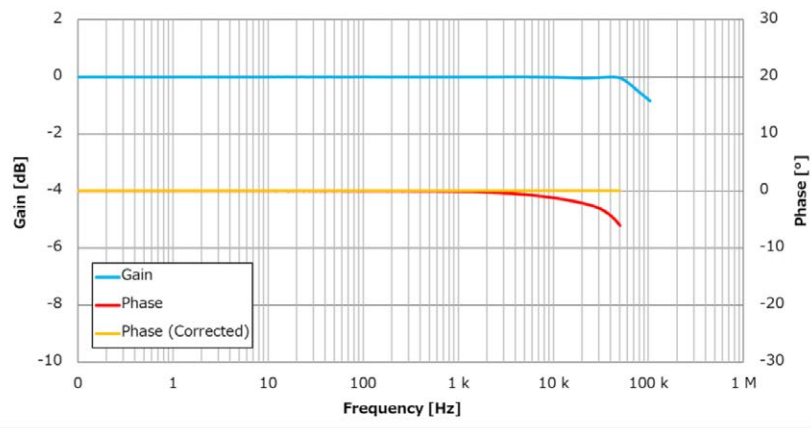

Phase Compensation Values

Enter the following values (representative values) when performing phase compensation on the PW6001 or PW3390.

When connecting to PW8001, PW4001 or LR8101/LR8102 with M7103, it will be set automatically.

CT6846A: 10 kHz, -1.05°

Figure 3. Part names

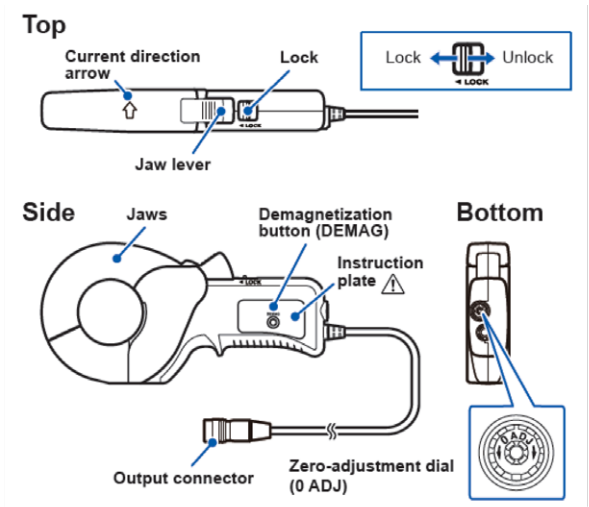

HIOKI E.E. CORPORATION

All information correct as of May 11, 2026. HIOKI E.E. CORPORATION
 Company names and product names appearing in this catalog are trademarks or registered trademarks of various companies.
 Written in Japan
 All specifications are subject to change without notice.

CT6846A

AC/DC CURRENT PROBE

Figure 4. Demagnetization (DEMAG) and zero adjustment (0 ADJ)

Immediately after the device is turned on or if an overcurrent exceeding the rated current is input, the device will output an offset. The offset will cause an error in DC current measurement, so perform demagnetization and zero adjustment as follows:

When connected to the CT9555, CT9556, or CT9557

1. Open the jaws and then press the demagnetization (DEMAG) buttons on the device and the CT9555, CT9556, or CT9557.
2. Open and close the jaws multiple times, and check that the display (offset output) on the measuring instrument is stable.
3. Lock the jaws.
4. Turn the zero adjustment dial (0 ADJ). Check the offset output displayed on the measuring instrument and make adjustments until the value is within:

- ±0.5 mV (CT6841A)
- ±0.2 mV (CT6843A, CT6844A, CT6845A, CT6846A)
- ±0.1 mV (CT6847 A)

When connected to equipment with a zero adjustment function

1. Lock the jaws.
2. Align the depression on the zero adjustment dial (0 ADJ) with the fitting surface.
3. Execute the zero adjustment from the measuring instrument.

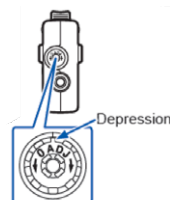

- Zero adjustment cannot be performed while a current is being input.
- The offset output varies depending on the surrounding environment, such as the temperature, terrestrial magnetism, and equipment that generates magnetic fields. Perform zero adjustment with the device at the location where you will measure current.
- Mechanical shocks such as dropping the device may cause the offset to shift.
- If zero adjustment is unsuccessful, perform demagnetization (DEMAG) several times with the jaws closed.

Measurement procedure

1. Connect the device to a measuring instrument that is powered off.
2. Turn on the measuring instrument.
3. Perform demagnetization (DEMAG) and zero adjustment (0 ADJ). See: "Demagnetization (DEMAG) and zero adjustment (0 ADJ)" (p. 17)
4. Unlock and open the jaws.
CT6845A, CT6846A, CT6847A
 (1) Unlock
 (2) Open the jaws (press the open/close lever)

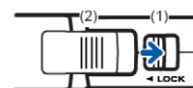
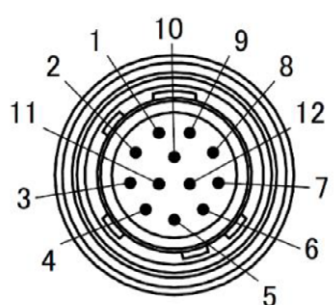
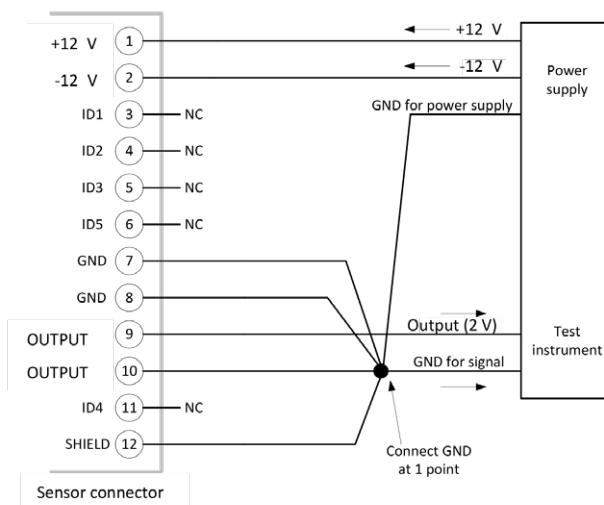

Figure 5. Pin assignment (when not using the sensor units CT9555, CT9556, or CT9557)



Output connector HIOKI ME15W of current sensors
 HIROSE ELECTRIC CO., LTD.
 HR10A-10P-12P (74)



CT6846A

AC/DC CURRENT PROBE

Figure 6. Options and main combination

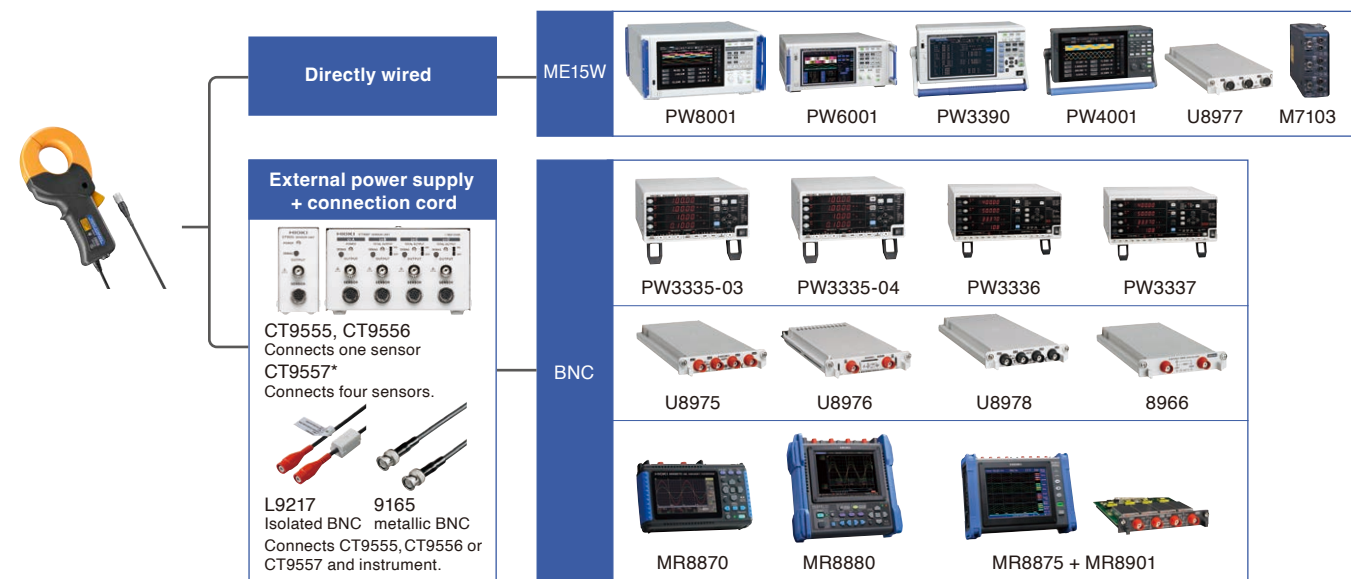

The CT9557 not only functions as a 4-channel power supply, but can also output additive waveform and RMS output from up to four input waveforms.

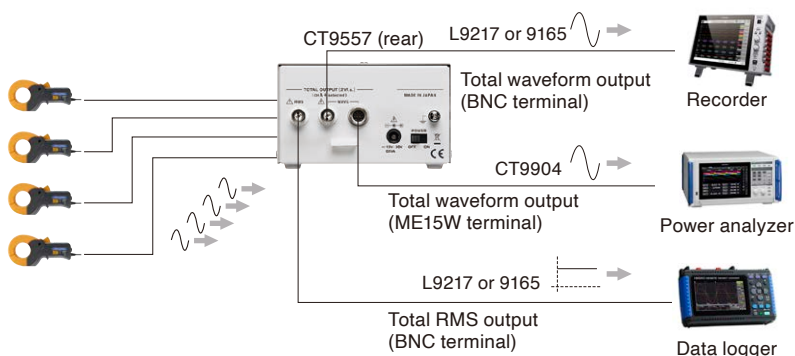

CT9904 CONNECTION CABLE
ME15W (12 pin) terminal - ME15W (12 pin) terminal
The CT9904 is the cable for the CT9557 addition output and POWER ANALYZER PW8001/PW6001/PW4001/PW3390/M7103 connection.



CT9902 EXTENSION CABLE
ME15W (12 pin) terminal - ME15W (12 pin) terminal
The CT9902 can be used to extend a current sensor's cable by 5m. Up two of these cables can be used for a maximum extension of 10 m.
*When using the CT9902, an additional accuracy needs to be added. For details, see the sensor's user manual.

Links

1. Web site
https://www.hioki.com/global/products/current-probes/high-clamp/id_507837
2. Accuracy calculation tools
PW8001, PW6001, PW4001, PW3390, LR8101/LR8102 (M7103): <https://hioki-cierto.com/gl/fm50bha8wk/>

Files and information such as the Power Analyzer or the Data Logger with the Power Measurement Module accuracy calculation tools are updated regularly. Instead of downloading them once and using them for a long time, download them from the download link just before using them.

HIOKI E.E. CORPORATION | All information correct as of May 11, 2026. HIOKI E.E. CORPORATION
Company names and product names appearing in this catalog are trademarks or registered trademarks of various companies.
Written in Japan
All specifications are subject to change without notice.