

LR8431-20

HIOKI

Instruction Manual

MEMORY HiLOGGER

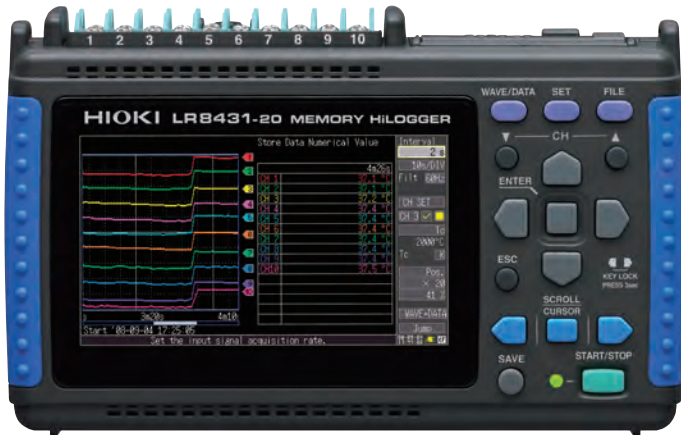

EN

June 2018 Revised edition 4
LR8431B980-04 18-06H



Contents

Introduction	1
Confirming Package Contents	2
Safety Information	3
Operating Precautions	6

Chapter 1

Overview 13

1.1 Product Overview and Features	13
1.2 Measurement Flow	14
1.3 Names and Functions of Parts	16
1.4 Screen Configurations	18
1.5 Basic Operation	21
■ Screen Operations	21
■ Starting and Stopping Recording	22
■ Disabling Key Operations (Key-Lock Function)	23
■ Saving Data	23
■ Verifying the Input Level (Level Monitor)	24

Chapter 2

Measurement Preparations 25

2.1 Using the Battery Pack (Option)	26
■ Install the Battery Pack	29
■ Charge the Battery Pack	29
2.2 Connecting the AC Adapter	30
2.3 Connecting Measurement Cables to the Memory HiLogger	31
■ Connecting Measurement Leads or Thermocouples (for voltage or temperature, respectively)	32
■ Connecting the Optional Model 9641 Connection Cable (for Pulse Signal Input)	33
2.4 Turning the Power On and Off	34
2.5 Zero Adjustment	35

Chapter 3	
Setting before Measurement	37
3.1 Pre-Operation Inspection	37
3.2 Operating Flow Overview	38
3.3 Setting Configuration 1 – Recording Settings	42
■ Specify the Recording Interval	42
■ Setting the Display Time Base (horizontal axis magnification, set as needed)	43
■ Selecting the Recording Start/stop Method	44
■ Set the Recording Length for Repeated or One-time Recording	45
■ Enable Digital Filtering (noise suppression) (as needed)	45
■ Automatic Saving	46
■ Replacing Removable Storage During Real-Time Saving	48
3.4 Setting Configuration 2 – Input Channel Settings	49
■ Voltage Measurement Settings	50
■ Temperature Measurement Settings	51
■ Integration (Count) Measurement Settings	53
■ Revolution Measurement Settings	54
3.5 Display Settings	56
■ Selecting Waveform Display Color	56
■ Specifying Vertical Display Range by Magnification and Zero Position (vertical axis expansion/compression)	56
■ Specifying the Vertical Display Range by Upper and Lower Limits (expansion/compression)	57
■ Converting Units (Scaling function)	58
3.6 Entering Comments	60
3.7 Viewing All Channel Settings in a List	62
■ Batch Copying Channel Settings	63
■ Batch Setting Waveform Display/Hide and Waveform Color Settings for All Channels	63
■ Initializing Settings (to factory defaults)	64
■ Aligning Zero Positions on the Grid	64
■ Display Celsius (°C) temperature values as Fahrenheit (°F)	65

Chapter 4

Specifying Criteria for Measurements (Triggering, Alarm and Timer) _____ 67

- 4.1 Setting Criteria to Start and Stop Recording 68**
 - Setting the Input Signal Trigger Threshold (Level Trigger) 69
 - Setting Lower and Upper Trigger Thresholds (Window Trigger) 70
 - Selecting Trigger Sources and Combinations 71
 - Setting Criteria for Pre-Trigger Recording (Pre-Trig) 72
- 4.2 Alarm Output 73**
- 4.3 Confirming Trigger and Alarm Criteria Settings (List) 75**
- 4.4 Starting and Stopping Recording by Timer 76**
- 4.5 About Recording Operation 78**

Chapter 5

Waveform Analysis _____ 81

- 5.1 Viewing Waveforms 82**
 - Scrolling Waveforms 82
 - Verifying Waveform Display Position 82
 - Magnifying and Compressing Horizontally 83
 - Viewing Any Waveform Location (Jump Function) 83
- 5.2 Selecting Display Options 84**
 - Displaying Gauges 84
 - Displaying Cursor Values 84
 - Specifying a Waveform Time Span 86
 - Viewing Input Signals as Numerical Values 87
- 5.3 Inserting Event Marks (Search Function) 88**
 - Inserting Event Marks While Viewing Waveforms 88
 - Inserting Event Marks Using External Input Signals 89
 - Searching Event Marks 90

Chapter 6

Saving & Loading Data _____ 91

- 6.1 About Saving and Loading Data 91**
- 6.2 Using a CF Card/USB flash drive 93**
 - CF Card Insertion & Removal 94

■	USB flash drive Insertion & Removal	94
■	Formatting a CF Card/USB flash drive	95
6.3	Saving Data	96
■	Automatic Saving	97
■	Selecting the Manual Saving Method [Quick Save]/[Select & Save]	98
■	Saving Waveform Data (with the SAVE Key)	99
■	Capturing a Screen Image (With the SAVE Key)	100
■	Saving Numerical Calculation Results (With the SAVE Key)	101
■	Saving Setting Configurations	102
6.4	Loading Data on the Memory HiLogger	103
■	Loading a Setting Configuration	103
■	Loading Waveform Data and Screen Images	104
6.5	Data Management	105
■	Switching removable storage	105
■	Viewing Folder Contents and the Parent Folder	106
■	Deleting Data	106
■	Renaming Files and Folders	107
■	Copying Data	108
■	Sorting Files	109
6.6	Transferring Data to a Computer (USB Drive Mode)	110
■	Select the USB Drive Mode	110
■	Connecting the USB Cable	111

Chapter 7

Numerical Calculations _____ 113

7.1	Calculation Methods	113
■	Auto Calculation	114
■	Manual Calculation	115
■	Apply Calculations to a Specific Time Span (Manual Calculation Only)	116
7.2	Numerical Value Calculation Expressions	117

Chapter 8 System Environment Settings _____ 119

- 8.1 Screen and Key Operation Settings 120
 - Using the Auto-Resume Function (Resume After Power Restoration) 120
 - Adjust Backlight Brightness 120
 - Enabling and Disabling the Backlight Saver 121
 - Selecting Black or White Screen Background 121
 - Enabling or Disabling the Beeper 121
 - Selecting the Horizontal (Time) Axis Display 122
 - Selecting the Display Language 122
- 8.2 CSV File Saving Settings 123
 - CSV File Data Decimal and Separator Characters 123
- 8.3 Making System Settings 124
 - Setting the Date and Time 124
 - Initializing the Memory HiLogger (System Reset) 125
 - Switching the USB mode 126
 - Self-Test 127

Chapter 9 External Control _____ 129

- 9.1 Connecting to the External Control Terminals ... 129
- 9.2 External Trigger Input 131
- 9.3 External Signal Output (Trigger Output) 132
- 9.4 Alarm Signal Output (Alarm Output) 134
- 9.5 Synchronous Measurements with Multiple Instruments 135

Chapter 10 Specifications _____ 137

Chapter 11 Maintenance and Service _____ 147

- 11.1 Troubleshooting 147
- 11.2 Cleaning 149
- 11.3 Disposing of the Instrument 150

6

7

8

9

10

11

Appendix

Index

Appendix _____ A1

Appendix 1 Error Messages and Remedial ActionsA1
Appendix 2 File NamingA7
Appendix 3 Text File (CSV) Internal FormatA8
Appendix 4 Binary File Size Calculation.....A9
Appendix 5 List of Default Settings.....A10
Appendix 6 Maximum Recordable TimeA11
Appendix 7 ReferenceA12
Appendix 8 Concerning Noise CountermeasuresA13
Appendix 9 Using the Application ProgramA19
 ■ Installing Logger UtilityA20
 ■ Installing the USB DriverA23
 ■ Connecting the Memory HiLogger to the Computer with
 a USB CableA26
 ■ Starting and Ending Logger UtilityA29
 ■ Uninstalling the Logger UtilityA29
Appendix 10Frequently Asked QuestionsA30
 ■ Installation and SettingsA30
 ■ TriggeringA32
 ■ MeasuringA33
 ■ Data SavingA34
 ■ Logger UtilityA38
Appendix 11Pulse Input Circuit Diagram.....A39

Index _____ Index 1

Introduction

Thank you for purchasing the HIOKI "Model LR8431-20 Memory HiLogger."

To obtain maximum performance from the instrument, please read this manual carefully, and keep it handy for future reference.

Trademarks

- Microsoft, Windows, Excel, are either registered trademarks or trademarks of Microsoft Corporation in the United States and other countries.
 - CompactFlash is a registered trademark of Sandisk Corporation (USA).
-

Confirming Package Contents

When you receive the instrument, inspect it carefully to ensure that no damage occurred during shipping. In particular, check the accessories, panel switches, and connectors. If damage is evident, or if it fails to operate according to the specifications, contact your dealer or Hioki representative.

Confirm that these contents are provided.

- Model LR8431-20 1 Measurement Guide 1
Memory HiLogger

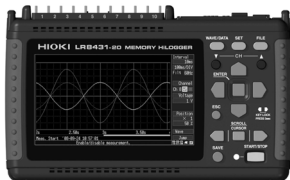

- USB Cable 1

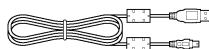

(p. A26)

- Model Z1005 AC Adapter 1 CD 1
with supplied power cord

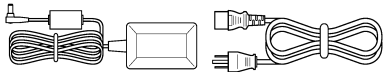

(p. 30)

- Instruction Manual (PDF)
(This document)
- Logger Utility Instruction Manual (PDF)
- Logger Utility (Data acquisition application program)



The latest version can be downloaded from our web site.

About options:

Contact your dealer or Hioki representative for details.

- | | |
|---|--|
| <input type="checkbox"/> Model 9780 Battery Pack | <input type="checkbox"/> Model 9727 PC Card (256MB) |
| <input type="checkbox"/> Model Z1005 AC Adapter | <input type="checkbox"/> Model 9728 PC Card (512MB) |
| <input type="checkbox"/> Model 9641 Connection Cable (for pulse inputs) | <input type="checkbox"/> Model 9729 PC Card (1GB) |
| <input type="checkbox"/> Model 9782 Carrying Case | <input type="checkbox"/> Model 9830 PC Card (2GB) |
| <input type="checkbox"/> Model 9812 Soft Case | <input type="checkbox"/> Model 9809 Protection Sheet |









Safety Information





This instrument is designed to comply with IEC 61010 Safety Standards, and has been thoroughly tested for safety prior to shipment. However, mishandling during use could result in injury or death, as well as damage to the instrument. However, using the instrument in a way not described in this manual may negate the provided safety features. Be certain that you understand the instructions and precautions in the manual before use. We disclaim any responsibility for accidents or injuries not resulting directly from instrument defects.

This manual contains information and warnings essential for safe operation of the instrument and for maintaining it in safe operating condition. Before using it, be sure to carefully read the following safety precautions.



Safety Symbols

	In the manual, the  symbol indicates particularly important information that the user should read before using the instrument.
	The  symbol printed on the instrument indicates that the user should refer to a corresponding topic in the manual (marked with the  symbol) before using the relevant function.
	Indicates DC (Direct Current).
	Indicates AC (Alternating Current).
	Indicates the ON side of the power switch.
	Indicates the OFF side of the power switch.

The following symbols in this manual indicate the relative importance of cautions and warnings.

 DANGER	Indicates that incorrect operation presents an extreme hazard that could result in serious injury or death to the user.
 WARNING	Indicates that incorrect operation presents a significant hazard that could result in serious injury or death to the user.
 CAUTION	Indicates that incorrect operation presents a possibility of injury to the user or damage to the instrument.
NOTE	Indicates advisory items related to performance or correct operation of the instrument.

Symbols for Various Standards

	Indicates that the product conforms to regulations set out by the EU Directive.
	This is a recycle mark established under the Resource Recycling Promotion Law (only for Japan).
	WEEE marking: This symbol indicates that the electrical and electronic appliance is put on the EU market after August 13, 2005, and producers of the Member States are required to display it on the appliance under Article 11.2 of Directive 2002/96/EC (WEEE).

Other Symbols

	Indicates the prohibited action.
(p. #)	Indicates the location of reference information.
*	Indicates that descriptive information is provided below.
[]	The names of setting objects and buttons on the screen are indicated by square brackets [].
SET (Bold characters)	Bold characters within the text indicate operating key labels.
Unless otherwise specified, "Windows" represents Windows XP, Windows Vista, Windows 7, Windows 8 or Windows 10.	
Click: Press and quickly release the left button of the mouse. Double click: Quickly click the left button of the mouse twice.	

Accuracy

We define measurement tolerances in terms of f.s. (full scale), rdg. (reading) and dgt. (digit) values, with the following meanings:

f.s. (maximum display value or scale length)

The maximum displayable value or scale length. This is usually the name of the currently selected range.

Example: For the 1 V range, f.s. = 1 V

rdg. (reading or displayed value)

The value currently being measured and indicated on the measuring instrument.

dgt. (resolution)

The smallest displayable unit on a digital measuring instrument, i.e., the input value that causes the digital display to show a "1" as the least-significant digit.

Measurement categories

To ensure safe operation of measurement instruments, IEC 61010 establishes safety standards for various electrical environments, categorized as CAT II to CAT IV, and called measurement categories.

CAT II	Primary electrical circuits in equipment connected to an AC electrical outlet by a power cord (portable tools, household appliances, etc.) CAT II covers directly measuring electrical outlet receptacles.
CAT III	Primary electrical circuits of heavy equipment (fixed installations) connected directly to the distribution panel, and feeders from the distribution panel to outlets.
CAT IV	The circuit from the service drop to the service entrance, and to the power meter and primary overcurrent protection device (distribution panel).

Using a measurement instrument in an environment designated with a higher-numbered category than that for which the instrument is rated could result in a severe accident, and must be carefully avoided.

Use of a measurement instrument that is not CAT-rated in CAT II to CAT IV measurement applications could result in a severe accident, and must be carefully avoided.

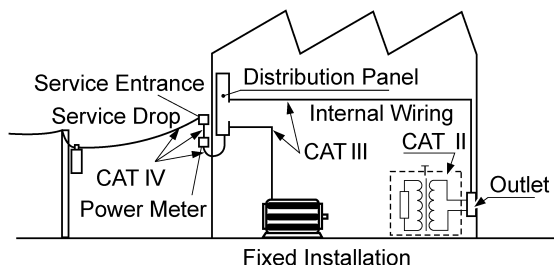

Difference between "Measurement" and "Recording"

The measurement and recording processes are distinguished as follows for the purposes of these instructions.

Measurement:	The acquisition of input values into internal HiLogger memory or to a PC via communications.
Recording:	Storing measurement data on a CF card, USB flash drive or on a PC via data communication.

Measured data (data acquired in internal memory) is erased whenever a new measurement starts. To retain data, always record (save) it.

Operating Precautions



Follow these precautions to ensure safe operation and to obtain the full benefits of the various functions.

Before Use

- Before using the instrument for the first time, verify that it operates normally to ensure that no damage occurred during storage or shipping. If you find any damage, contact your dealer or Hioki representative.
- Before using the instrument, make sure that the insulation on the cables is undamaged and that no bare conductors are improperly exposed. Using the instrument in such conditions could cause an electric shock, so contact your dealer or Hioki representative for replacements.

Instrument Installation

- Operating temperature and humidity: 0 to 40°C at 80% RH or less (non-condensating)
- Temperature and humidity range for guaranteed accuracy: 23±5°C, 80%RH or less

Avoid the following locations that could cause an accident or damage to the instrument.



Exposed to direct sunlight
Exposed to high temperature



In the presence of corrosive
or explosive gases



Exposed to water, oil, other
chemicals, or solvents
Exposed to high humidity or
condensation



Exposed to strong electro-
magnetic fields
Near electromagnetic radia-
tors



Exposed to high levels of
particulate dust



Near induction heating sys-
tems
(e.g., high-frequency induc-
tion heating systems and IH
cooking utensils)



Subject to vibration



The maximum operating (ambient) temperature for the LR431-20 is 40°C. Do not attempt to use in higher temperature environments.

NOTE

- Correct measurement may be impossible in the presence of strong magnetic fields, such as near transformers and high-current conductors, or in the presence of strong electromagnetic fields such as near radio transmitters.
- If liquid enters the enclosure through an air vent or other opening, it may damage the instrument's internal circuitry. Exercise caution concerning the surrounding environment when installing the instrument.

Installation Precautions

- If the instrument is used in any state other than the following, the measurement accuracy may not satisfy the device specifications.

Horizontal placement



Upright placement

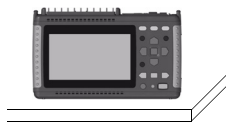

- Leave sufficient space around the ventilation holes and install the instrument with the holes unobstructed.
- Avoid temperature changes around the terminal block. Especially avoid directed airflow such as from an electric fan or air conditioner vent. Thermocouple inputs are prone to measurement errors.
- When the HiLogger is moved to a location with significantly different ambient temperature, allow at least 30 minutes for thermal equalization before measuring.

Handling the Instrument**WARNING**

- **Do not allow the instrument to get wet, and do not take measurements with wet hands. This may cause an electric shock.**
- **Do not attempt to modify, disassemble or repair the instrument; as fire, electric shock and injury could result.**

CAUTION

To avoid damage to the instrument, protect it from physical shock when transporting and handling. Be especially careful to avoid physical shock from dropping.

NOTE

This instrument may cause interference if used in residential areas. Such use must be avoided unless the user takes special measures to reduce electromagnetic emissions to prevent interference to the reception of radio and television broadcasts.

Handling the Cords and Cables

CAUTION

- Avoid stepping on or pinching cables, which could damage the cable insulation.
- To avoid breaking the cables and probes, do not bend or pull them.
- To avoid damaging the power cord, grasp the plug, not the cord, when unplugging it from the power outlet.

Before Turning Power On

WARNING

Using the Battery Pack

- For battery operation, use only the HIOKI Model 9780 Battery Pack. We do not take any responsibility for accidents or damage related to the use of any other batteries.

See: 2.1, "Using the Battery Pack (Option)" (p. 26)

Using the AC Adapter

- Use only the supplied Model Z1005 AC Adapter. AC adapter input voltage range is 100 to 240 VAC (with $\pm 10\%$ stability) at 50/60 Hz. To avoid electrical hazards and damage to the instrument, do not apply voltage outside of this range.
- Turn the instrument off before connecting the AC adapter to the instrument and to AC power.
- To avoid electrical accidents and to maintain the safety specifications of this instrument, connect the power cord provided only to a 3-contact (two-conductor + ground) outlet.
- Use only the designated power cord with this instrument. Use of other power cords may cause fire.
- Before turning the instrument on, make sure the supply voltage matches that indicated on its power connector. Connection to an improper supply voltage may damage the instrument and present an electrical hazard.

CAUTION

When the power is turned off, do not apply voltage or current to the connectors. Doing so may damage the instrument.

NOTE

- After use, always turn OFF the power.
- Brief power interruptions of 40 ms or less will not cause this instrument to malfunction. However, Longer interruptions may cause the Memory HiLogger to shut itself off, so consider local power conditions before installing, as appropriate.
- To ensure that recording is not interrupted by power outages, you can use the Z1005 AC Adapter and 9780 Battery Pack together.

About Inputs and Measurement

⚠ DANGER

- The maximum input voltage (and the maximum rated voltage to earth) for the analog input terminals is 30 Vrms (or 60 V DC). If these limits are exceeded, the instrument may be damaged and personal injury or death could occur, so do not attempt measurement.
- Do not leave the Memory HiLogger connected to test objects in environments where a voltage surge might exceed the dielectric withstand voltage. Doing so could result in damage to the Memory HiLogger, bodily injury or fatal accident.
- Channels are insulated by semiconductor relays. When a voltage beyond the specification is applied between the channels, the semiconductor relay may short circuit. Please ensure that a voltage beyond specification, especially a surge such as a lightning, is never applied. When an abnormal measurement value is observed, please contact your dealer or Hioki representative for inspection.

NOTE

The waveform for an open channel may sometimes appear to be influenced by the signals of the other channels being measured. If you do not like this, please set the waveform display of the open channel to OFF or short-circuit the input terminals of the open channel by connecting the positive and negative terminal.

CD Handling

- Always hold the disc by the edges, so as not to make fingerprints on the disc or scratch the printing.
- Never touch the recorded side of the disc. Do not place the disc directly on anything hard.
- Do not wet the disc with volatile alcohol or water, as there is a possibility of the label printing disappearing.
- To write on the disc label surface, use a spirit-based felt pen. Do not use a ball-point pen or hard-tipped pen, because there is a danger of scratching the surface and corrupting the data. Do not use adhesive labels.
- Do not expose the disc directly to the sun's rays, or keep it in conditions of high temperature or humidity, as there is a danger of warping, with consequent loss of data.
- To remove dirt, dust, or fingerprints from the disc, wipe with a dry cloth, or use a CD cleaner. Always wipe from the inside to the outside, and do no wipe with circular movements. Never use abrasives or solvent cleaners.
- Hioki shall not be held liable for any problems with a computer system that arises from the use of this CD, or for any problem related to the purchase of a Hioki product.

Using a CF Card/USB flash drive

CAUTION

- Inserting a CF card/USB flash drive upside down, backwards or in the wrong direction may damage the CF card, USB flash drive, or HiLogger.
- Never eject a CF card /USB flash drive while measuring or when the HiLogger is or accessing the card. Data on the CF card/USB flash drive may be destroyed. (The CF icon/USB flash drive icon at the lower right is red while the card is being accessed.)
- Do not transport the HiLogger while a USB flash drive is connected. Damage could result.
- As the CF card/USB flash drive is sensitive to static electricity, damage to the CF card/USB flash drive or wrong operations by the HiLogger may occur due to static electricity. Please be careful when handling it.
- With some USB flash drives, the HiLogger may not start up if power is turned on while the USB flash drive is inserted. In such a case, turn power on first, and then insert the USB flash drive. It is recommended to try out operation with a USB flash drive before starting to use it for actual measurements.

NOTE

- The Flash memory in a CF card/USB flash drive has a limited operating life. After long-term usage, data storage and retrieval become difficult. In this case, replace the CF card/USB flash drive with a new one.
- We cannot provide compensation for data loss in a CF card/USB flash drive, regardless of content or cause of the damage. Data is also cleared from memory if a long time passes after measuring. Always maintain a backup of important data stored on a CF card/USB flash drive.
- Although real-time saving to USB flash drive is supported, a CF card is recommended for data preservation. Performance cannot be guaranteed when using storage media other than a Hioki-specified CF card option.
- Use a USB flash drive whose continuous current consumption does not exceed 300 mA (peak 500 mA). (The peak value is displayed as "Max Power" under the USB flash drive self-test on the [System] screen.)
- Depending on how USB is used, the USB connector and instrument settings may vary as shown in the chart below.
- The three USB methods of use described in the chart below involve exclusive settings and cannot be used simultaneously.

USB method of use	Connector used	[System] screen USB mode setting
Use a USB flash drive.	Type A	USB Memory (Default)
Communicate with the LR8431-20 and initiate measurement using the Logger Utility software from a computer (using a USB cable).	Type B	USB Communication
Read files on a CF card that is connected to the LR8431-20 from a computer (using a USB cable).	Type B	USB Drive

Overview

Chapter 1

1.1 Product Overview and Features

The Hioki LR8431-20 Memory HiLogger is a compact, lightweight, easy-to-operate waveform recorder. It can run on batteries, and can be quickly deployed when a power anomaly occurs.

Measurement data can be monitored, subjected to calculations and analyzed on a personal computer using the supplied application program.

Observe voltage fluctuations and temperature changes

Just connect measurement leads or thermocouples to measure as needed.



Acquire pulse signals

Measure integrated pulses or revolutions from sensors and pulse output devices such as watt-hour meters.



Record anomalies

Abnormal events can be analyzed by recording with the trigger function (p. 67). Use the alarm function to output signals when anomalies occur (p. 73).

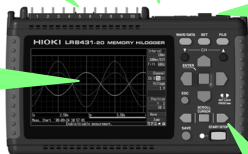
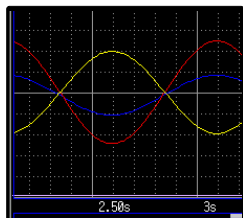
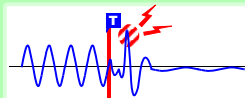

Measurement data and setting configurations are stored, read and managed as data files

Measurement data can be stored to and read from a CF card or USB flash drive (p. 91).

Waveform analysis

Gauge display (p. 84)



Zoom in/out (p. 83)



Numerical display (p. 87)

123.4V

Event search (p. 88)



Cursor Measurements (p. 84)



Using the A/B cursors, values at cursor locations on waveforms and the time at trigger positions can be displayed.

Numerical Calculations (p. 113)



Performs six calculation types, including maximum and average values.

Analysis on a PC

Monitor and analyze measurement data with the supplied application program (p. A19).

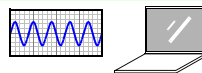

Display in converted units

Using the scaling function, input values can be displayed in units of the actual physical quantity being measured, such as current or flow volume (p. 58).

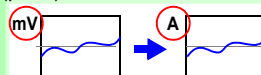

1.2 Measurement Flow

Installing, Connecting and Turning On

Install the Battery Pack (option) (p. 26)

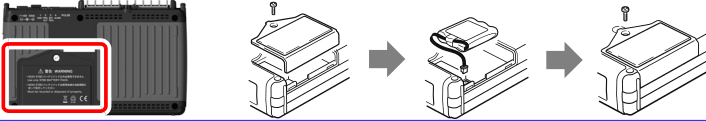

Connect to the Model LR8431-20 (p. 25), and Set Up (p. 7)

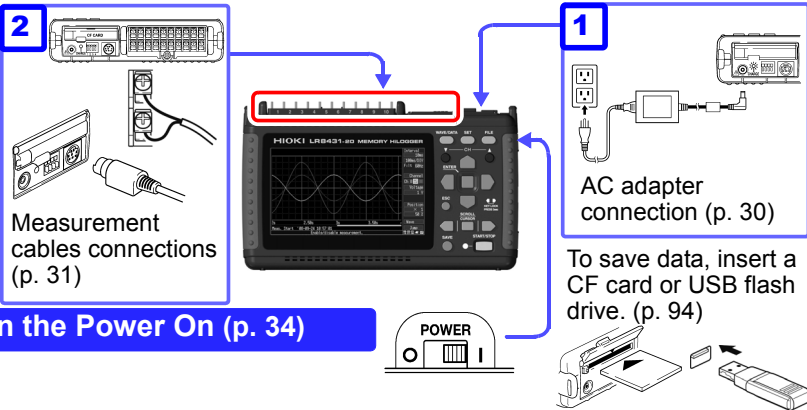

Turn the Power On (p. 34)

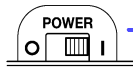

Settings

Configure Recording Settings (p. 38)

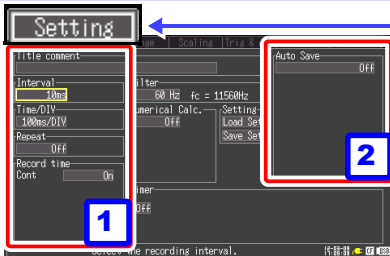
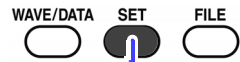

Set the data acquisition (recording) interval, and recording length (time span). Select the type of measurement data to save when automatically saving to a CF card or USB flash drive. Remaining data stored in the instrument can be saved when finished measuring.

Using a previously saved setting configuration

Reload a previously stored setting configuration from Model LR8431-20 memory or a CF card or USB flash drive, and measure (p. 103)

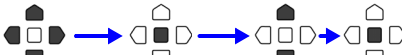

Move to a setting item Open the setting options Select Apply

Configure Input Channels (p. 38)

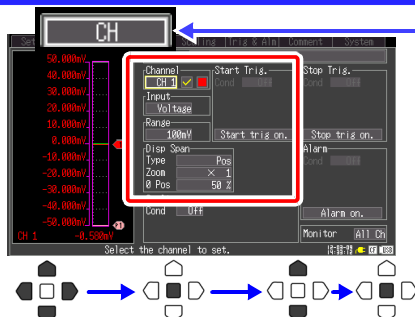

Select input channels, and set input types and measurement ranges.
Make other settings as desired.

Move to a setting item → Open the setting options → Select → Apply

Starting and Stopping Measurement

Press the START/STOP Key (p. 22)

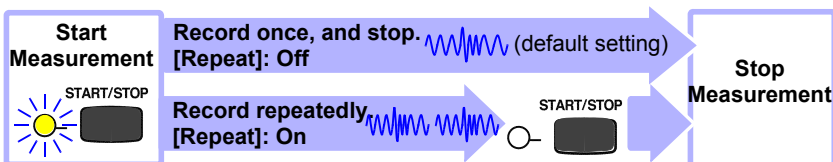

When recording using the trigger function, recording occurs only when the input waveform satisfies specified trigger criteria.

Data Analysis

View Measurement Data (p. 81)

Waveforms can be zoomed and numerical values confirmed.

Save Data (p. 91)

Measurement data, waveform data, screen images and numerical calculation results can be saved.

Calculate (p. 113)

Numerical measurement data can be applied to calculations.

View on a Computer (p. A19)

Analyze recorded data using the supplied application program.

When Finished

Turn the Memory HiLogger Off (p. 34)

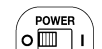

1.3 Names and Functions of Parts

Front Panel

Display Screen (p. 81)

4.3-inch TFT color LCD

Screen Configurations (p. 18)

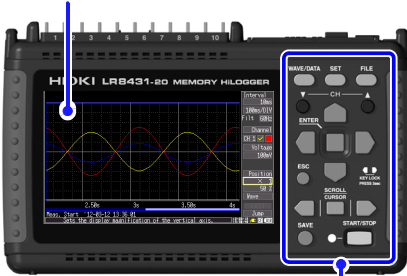

Operating Keys

Rear Panel

Manufacturer's Serial No.

Shows the serial number. The serial number consists of 9 digits. The first two (from the left) indicate the year of manufacture, and the next two indicate the month of manufacture. Do not remove this label, as it is required for product support.

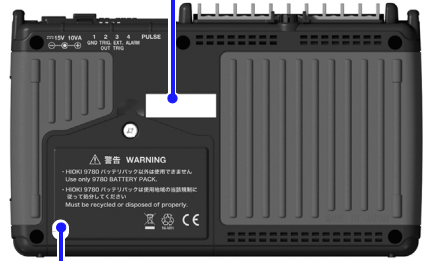

Battery Compartment (p. 26)

The optional Model 9780 Battery Pack is installed here.

Operating Keys

Choose a screen

■ WAVE/DATA

Selects among waveform screen displays (p. 18).

■ SET

Displays the Settings screens, and switches among the screen tabs with each press (p. 20).

■ FILE

Displays file information (p. 19).

Scroll waveforms and read cursor values

Press the center key to select waveform scrolling or A/B cursor movement, then press the left and right cursor keys to scroll or move (p. 21).

Saving operations

Press to save data manually (p. 96).

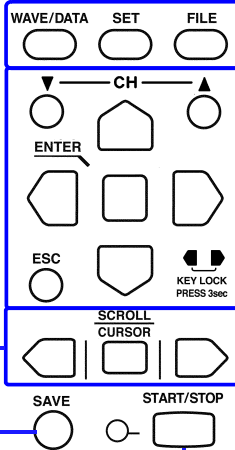

Start and stop measurement

Start and stop measurement. The LED at the left lights green while measuring (p. 22).

Setup and display

■ CH▼/▲

Select channels.

■ ESC

Cancels changes to settings.

■ Cursor Keys

Moves the position of the cursor (blinking selection) on the screen.



■ ENTER

Accepts displayed settings.



■ KEY LOCK

Disables keypad operations. Press and hold the left and right cursor keys simultaneously for three seconds to lock and unlock the keys.



■ (Zero Adjust)

Performs zero adjustment. Press the up and down keys simultaneously to execute (p. 35).



Top Panel

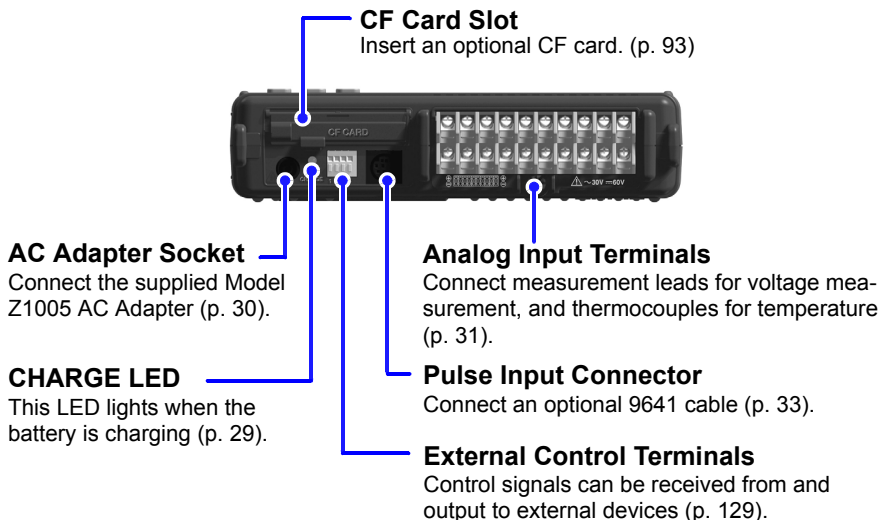

Right Side

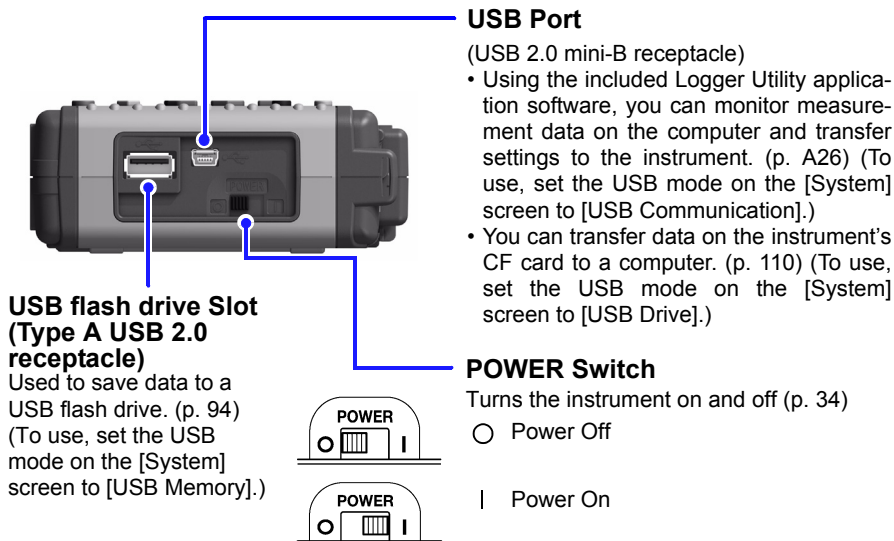

NOTE The [USB Memory], [USB Communication], and [USB Drive] USB mode settings are exclusive and cannot be used simultaneously.

1.4 Screen Configurations

Waveform/Numerical Screens



Selects between seven display types.

The screen switches each time you press the key.

Operational information is displayed along the bottom of the screen.



Selection is also available from the name of the current screen displayed near the bottom right

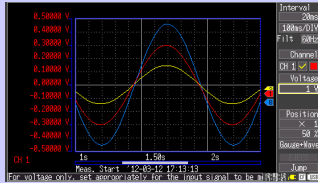
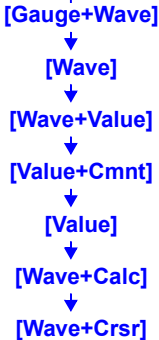

[Gauge+Wave] Screen

Measurement data is displayed as waveforms with gauges (p. 84).

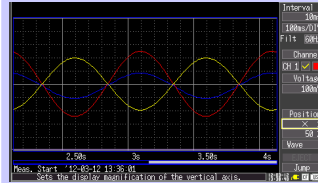

[Wave] Screen

Measurement data is displayed as waveforms (p. 81).

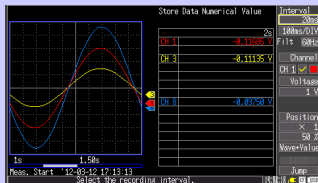

[Wave+Value] Screen

Measurement data is displayed as waveforms and numerical values (p. 87).

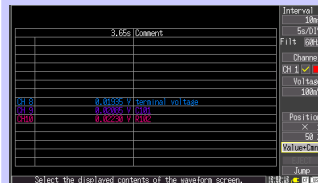

[Value+Cmnt] Screen

Measurement data is displayed as numerical values with comments (p. 87).



[Value] Screen

Measurement data is displayed as numerical values (p. 87).

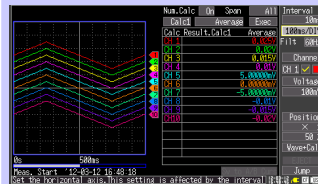

[Wave+Calc] Screen

Measurement data is displayed as waveforms with calculation results (p. 115).

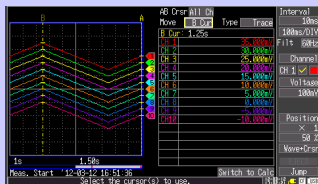

[Wave+Crsr] Screen

Measurement data is displayed as waveforms with cursor values (p. 84).

Waveform/Numerical Screens (About the Icons)

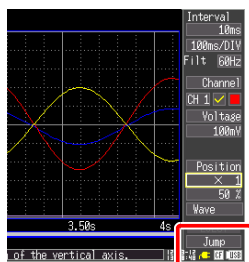

Clock
 "Setting the Date and Time"
 (p. 124)



USB source indicator
 Indicates the USB status.



Operating in USB Memory mode.



Operating in USB Communication mode.

CF card

Displayed when a CF card is inserted. The icon appears red when accessing the card.

Power source indicator

Indicates the Memory HiLogger's power source.



AC adapter operation



Battery pack operation (Fully charged battery pack)



Battery pack operation



Battery pack operation (Low battery indicator)

File Screen

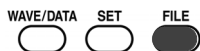

Operational information is displayed along the bottom of the screen.

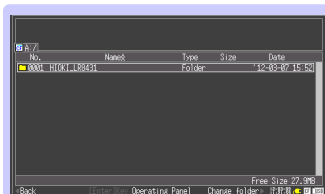

File Screen

View and manage files on the CF card or USB flash drive (p. 91).

Settings Screens



Selects between seven display types.

The screen switches each time you press the key.

Operational information is displayed along the bottom of the screen.

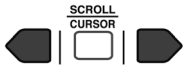

Press the left/right cursor keys to select between the Settings screens.

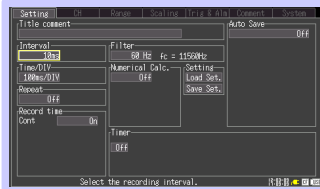
**[Setting] Screen**

Make settings for recording (p. 42). Set numerical calculation, auto-saving and timers.

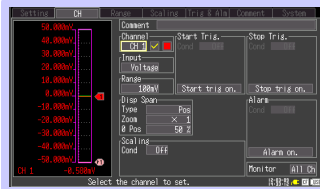
**[CH] Screen**

Make input channel settings while viewing the monitor display (p. 49).

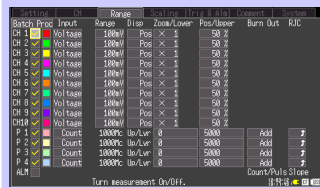
**[Range] Screen**

Make settings while viewing all channel settings (p. 62).

**[Scaling] Screen**

Make these settings to convert measured values to arbitrary units for display (p. 58).

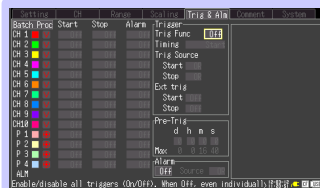
**[Trig & Alm] Screen**

Recording criteria (triggering) and warning sounds can be set for each channel (p. 67).

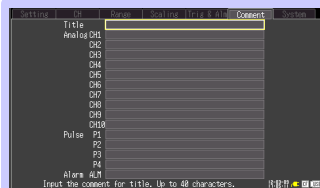
**[Comment] Screen**

Enter channel comments (p. 60)

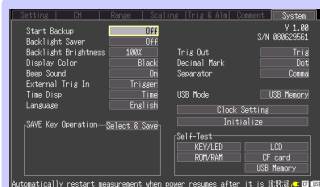
**[System] Screen**

Configure the system environment (p. 119).

1.5 Basic Operation

1

Chapter 1 Overview

Screen Operations

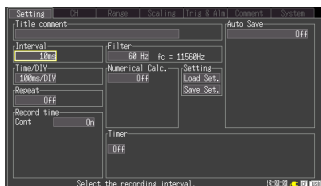

Setting Screen

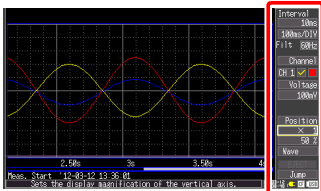

Waveform Screen

Changing screen contents

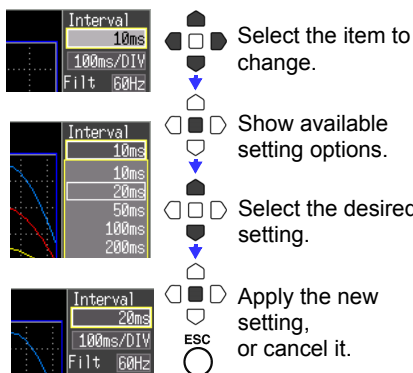

Scrolling a waveform

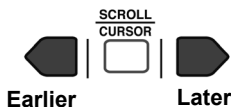

See: "Scrolling Waveforms" (p. 82)

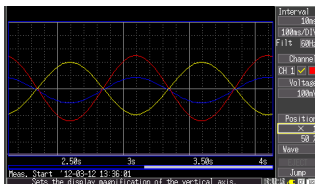

Reading values at cursors

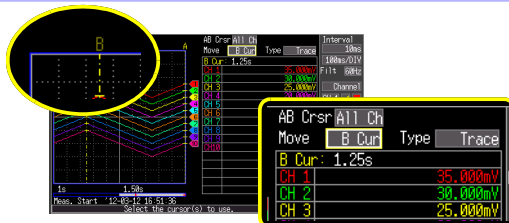
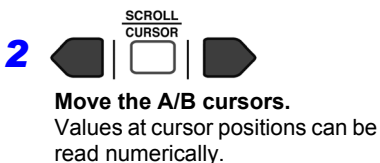
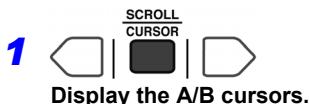

You can select the cursor display type and which cursor(s) to move (p. 84).

Starting and Stopping Recording

Acquire measurement data on the Memory HiLogger, and start recording. When recording stops depends on data recording settings (repeat recording, triggering, timers, etc.). (p. 78)

When you want measurement data to be automatically saved, before starting recording, check that auto-save is enabled (p. 46), that a CF card or USB flash drive is correctly inserted (p. 94), and that sufficient storage capacity is available (p. A11).

Start Measurement

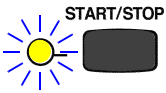

Press the **START/STOP** key.

The green LED lights.

When using the trigger function, the times when measurement starts and when recording (data acquisition) starts are not the same.

A confirmation message appears when you press the **START/STOP** key to start recording. Save important data to a CF card or USB flash drive before starting, because previous measurement data will be overwritten when recording starts.

Finish Measurement

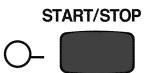

When **[Repeat]** (record multiple instances of the specified recording length) or **[Cont]** (record continuously) is enabled:

Pressing the **START/STOP** key stops recording.

When **[Repeat]** and **[Cont]** are disabled (Off):

Recording stops after the specified recording length. Pressing the **START/STOP** key during recording displays a confirmation message. Select **[Yes]** to stop recording.

For details about repeating and continuous recording:

See: "Selecting the Recording Start/stop Method" (p. 44)

"Set the Recording Length for Repeated or One-time Recording" (p. 45)

Disabling Key Operations (Key-Lock Function)

Keys can be disabled to avoid inadvertent operations.

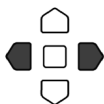

Press and hold the right and left cursor keys for three seconds to lock the other keys, and repeat to unlock.

Saving Data

Measurement data, settings, screen images and numerical calculation results can be saved.

For details of the saving methods, see Chapter 6, "Saving & Loading Data" (p. 91).

(Default settings)

Saving Method: [Select & Save] (Press the **SAVE** key to select and save data.)

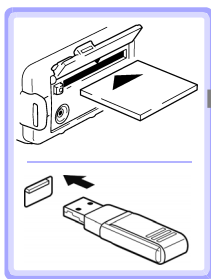

Insert a CF card or USB flash drive.

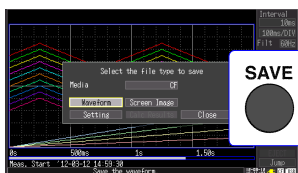

Press the **SAVE** key.
A dialog appears.

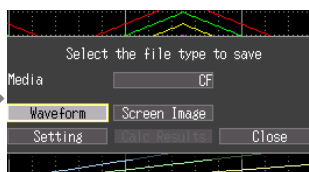

Select the save destination and item to save, and press ENTER key.
Select **[Yes]** in the confirmation dialog, and press ENTER again to save the data to the CF card or USB flash drive.

NOTE

- When using a USB flash drive, set the USB mode on the [System] screen to [USB Memory]. USB flash drives cannot be used while the USB mode setting is [USB Communication] or [USB Drive].
- The [USB Memory], [USB Communication], and [USB Drive] USB mode settings are exclusive and cannot be used simultaneously.

Verifying the Input Level (Level Monitor)

You can verify the input status and display range while making settings on the Setting screen. This is not available while measuring.

Level Monitor

Displayable Waveform Range
This is determined by the waveform display range setting.

Current Input Signal Level and Channel Number

Display Channel and Gauge
Shows the gauge for the currently selected channel. The gauge display is linked to the measurement and display range settings. Press the **CH** ∇/\blacktriangle keys to display the gauge for another channel.

Input Waveform Amplitude
Indicates real-time input amplitude. Using the Scaling function (p. 58), measurement units can be converted as desired for display.

Changing the Monitor Display
Select whether to display all channels, or only selected channels. **[All Ch]/[SlectCh]/[Value]**

- **[All Ch]**
The channels displayed in the level monitor are those with a check mark () displayed next to the channel number in the settings.
- **[SlectCh]** (Selected Channels)
The level monitor displays the channel selected on this screen.
- **[Value]**
The input values of all channels are displayed numerically.

Measurement Preparations

Chapter 2

2

Chapter 2 Measurement Preparations

1

Install the 9780 Battery Pack (option) (p. 26)



Rear View

2

Connect measurement cables (p. 31)

Voltage measurement:
Connect the measurement leads.

Temperature measurement:
Connect thermocouples.

Pulse signals:
Connect the Hioki 9641 connection cable

3

Connect the AC adapter (p. 30)



4

(To save data)
Insert a CF card or USB flash drive (p. 93)

External control signal inputs
External control signal outputs (p. 129)

5

Turn the power on (p. 34)
Execute zero adjustment (p. 35)

2.1 Using the Battery Pack (Option)



If commercial power is not available when the AC adapter is connected, the LR8431-20 Memory HiLogger can operate from the Model 9780 battery pack, so when using commercial power, the battery pack serves as a backup supply during power outages.

Charge the battery pack fully before using it the first time.



Be sure to observe the following precautions. Incorrect handling may result in liquid leaks, heat generation, ignition, bursting and other hazards.

- **Do not use a battery pack other than the 9780 Battery Pack. We cannot accept responsibility for accidents or damage related to the use of any other batteries.**
- **To avoid the possibility of explosion, do not short circuit, disassemble or incinerate battery pack.**
- **When storing the instrument, make sure no objects that could short-circuit the connectors are placed near them.**
- **The battery pack contains lye, which can cause blindness if comes into contact with the eyes. Should battery liquid get into your eyes, do not rub your eyes but rinse them in plenty of water and seek the immediate attention of a physician.**

Installing and replacing the battery pack

- **To avoid electric shock, turn off the power switch and disconnect the cables before replacing the battery pack.**
- **After installing or replacing the battery pack, replace the battery compartment cover and screw.**
- **Handle and dispose of batteries in accordance with local regulations.**

CAUTION

Observe the following to avoid damage to the instrument.

- Use the battery pack in an ambient temperature range of 0 to 40°C and charge it in an ambient temperature range of 5 to 30°C to be on the safe side.
- If the battery packs fails to complete charging within the stipulated time, disconnect the AC adapter from the pack to stop charging.
- Consult your dealer or nearest service station should liquid leaks, strange odor, heat, discoloration, deformation and other abnormal conditions occur during use, charging or storage. Should these conditions occur during use or charging, turn off and disconnect the instrument immediately.
- Do not expose the instrument to water and do not use it in excessively humid locations or locations exposed to rain.
- Do not expose the instrument to strong impacts and do not throw it around.

NOTE

- The battery pack is subject to self-discharge. Be sure to charge the battery pack before initial use.
- When recharging a discharged battery pack in the LR8431-20, allow it to charge for at least ten minutes with the LR8431-20 turned off to maximize battery longevity.
- The battery pack is a consumable. If the battery capacity remains very low after correct recharging, the useful battery life is at an end. It can be recharged up to about 500 times.
- To prevent battery pack deterioration when the battery will not be used for 1 month or longer, remove it and store it in a dry location with an ambient temperature range of between -10 to 30°C. Be sure to discharge and charge it every two months. Long-term storage when capacity has decreased will make charging impossible and reduce performance.
- Remove the battery pack from instrument once a month and check that appearance is normal.
- As long as battery charge remains, waveform data is retained in internal memory while the Memory HiLogger is turned off, so the battery continues to gradually discharge. When the battery charge is depleted, stored waveform data is lost.

When to charge

When powering the instrument from the battery pack without the Model Z1005 AC Adapter, the low battery indicator () is displayed when the battery charge is depleted, indicating that the battery pack requires charging.

Note that if the Memory HiLogger is turned off under this situation, waveform data may fail to be backed up, and could be lost.

Approximate charging time:

About 200 minutes at 23°C when recharged at the first appearance of the low battery indicator.

Approximate continuous battery-only operating time

(When saving data to a CF card at a temperature of 23°C)

* When using a USB flash drive, the continuous operating time may decrease depending on the particular USB flash drive in use.

- After a full charge, with the LCD backlight always on (default setting): approximately 2.5 hours
- After a full charge, with the LCD backlight off (five minutes after last key-press): approximately 3 hours

See: "Enabling and Disabling the Backlight Saver" (p. 121)

Install the Battery Pack

Required tool:

One Phillips screwdriver
(No.2)

Important

Disconnect the AC adapter when installing the battery pack.

Battery Compartment
Cover

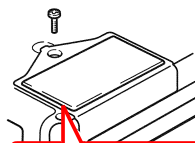
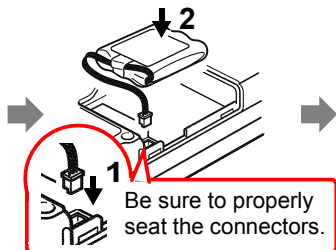
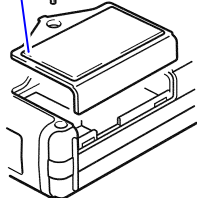

- 1 Place the Memory HiLogger face down, and remove the battery compartment cover screw and cover.
- 2 Connect the plugs of the battery pack to the connectors and insert the battery pack with the label side up.
- 3 Replace the battery compartment cover and screw.

Pull the battery pack plug straight out to remove the battery pack.

Charge the Battery Pack

Regardless of whether the Memory HiLogger is on or off, the battery pack recharges whenever the Z1005 AC Adapter is plugged in to a power source. Therefore, charging is provided by merely keeping the battery installed in the Memory HiLogger.

- 1 Connect the power cord to the inlet socket on the AC adapter.

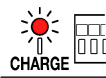
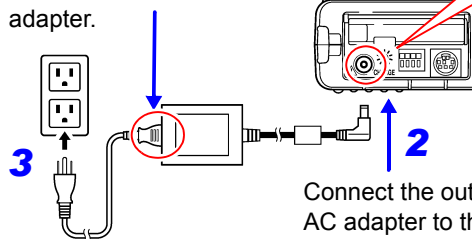

The CHARGE LED lights red when charging begins. Charging is finished when the CHARGE LED turns off.

Connect the output plug of the AC adapter to the instrument.

Plug the power cord into the mains outlet.

Refer to 2.2, "Connecting the AC Adapter" (p. 30) for details about the AC adapter.

2.2 Connecting the AC Adapter



Connect the power cord and the instrument to the supplied Model Z1005 AC Adapter, then plug the power cord into an outlet. When used with the battery pack installed, the battery serves as an operating backup supply in case of power failure, and the AC adapter otherwise has priority.

Before Connecting



WARNING

- Use only the supplied Model Z1005 AC Adapter. AC adapter input voltage range is 100 to 240 VAC (with $\pm 10\%$ stability) at 50/60 Hz. To avoid electrical hazards and damage to the instrument, do not apply voltage outside of this range.
- Turn the instrument off before connecting the AC adapter to the instrument and to AC power.
- To avoid electrical accidents and to maintain the safety specifications of this instrument, connect the power cord only to a 3-contact (two-conductor + ground) outlet.



CAUTION

To avoid damaging the power cord, grasp the plug, not the cord, when unplugging it from the power outlet.

- 1 Connect the power cord to the inlet socket on the AC adapter.

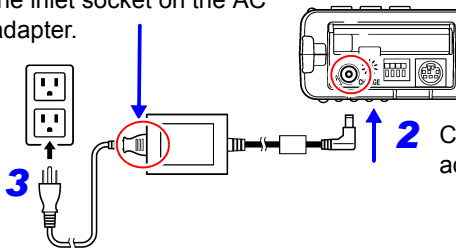

Rated supply voltage is 100 to 240 VAC, and rated supply frequency is 50 or 60 Hz.

- 2 Connect the output plug of the AC adapter to the instrument.

Plug the power cord into the mains outlet.

2.3 Connecting Measurement Cables to the Memory HiLogger



Connect the appropriate cables for the intended recording application.

- When recording voltage fluctuations or temperature changes (p. 32)
- When recording pulse signals (p. 33)

Be sure to read the "Operating Precautions" (p. 6) before connecting the cables. Connecting to the Analog Input Terminals



- The maximum input voltage (and the maximum rated voltage to earth) for the analog input terminals is 30 Vrms (or 60 V DC). If the voltage is exceeded, this device will be damaged and personal injury will result. Therefore, do not perform measurement in this case.
- Do not leave the Memory HiLogger connected to test objects in environments where a voltage surge might exceed the dielectric withstand voltage. Doing so could result in damage to the Memory HiLogger, bodily injury or fatal accident.



- Do not connect a cable to the instrument while it is connected to the object to be measured. Otherwise, an electric shock accident may occur.
- To avoid short-circuit accidents, make certain that connections are secure.
- Channels are insulated by semiconductor relays. When a voltage beyond the specification is applied between the channels, the semiconductor relay may short circuit. Please ensure that a voltage beyond specification, especially a surge such as a lightning, is never applied. When an abnormal measurement value is observed, please contact your dealer or Hioki representative for inspection.

NOTE

- Measurements may be affected by noise or other electromagnetic ingress if input leads are longer than about three meters.
- Route measurement leads and cables as far away as possible from power and earth lines.
- Measurement values may be scattered if the leads are routed in parallel with other devices. If they must be parallel, check operation before taking measurements.
- Avoid temperature changes around the terminal block. Especially avoid directed airflow such as from an electric fan or air-conditioner vent.
- If connecting crimped terminals to the analog input terminals, use insulated terminals for M3 screws with the size shown below.

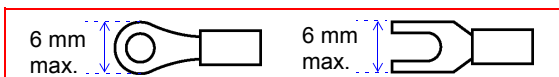

Connecting Measurement Leads or Thermocouples (for voltage or temperature, respectively)

Connect the voltage and temperature measurement (thermocouple) leads to the analog input terminals.

Tools required: Phillips screwdriver (for M3 screws)

The insulation colors of wires, which are to be connected to the plus and minus terminals, differ depending on countries or manufactures. Check with the manufacturer on the colors and connect them according to instructions.

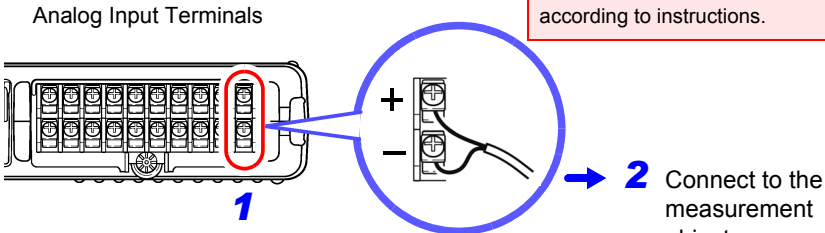

Using the screwdriver, loosen the terminal block screws, insert the bare ends of the leads, and tighten the screws.

When applying 4 - 20 mA input current

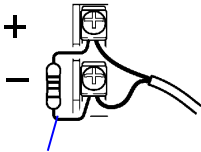

Connect a 250 Ω shunt resistor as shown.

(For details on instrumentation control equipment measurements, see p. 50 .)

NOTE

K,E thermocouples experience a physical phenomenon known as short range ordering, which can prevent accurate measurement within the range of 250°C to 600°C.

Please choose a sensor after checking with the manufacturer of the thermocouple you intend to use.

Connecting to the Pulse Input Connector



To avoid electric shock and short circuit accidents or damage to the instrument, pay attention to the following:

- The ground terminal for the optional 9641 Connection Cable is not isolated from the Memory HiLogger's ground (chassis ground). Therefore, if the measurement object connects to AC, it should have a grounded, polarized plug, and be connected to the same power outlet as the Memory HiLogger's AC adapter.
If the Memory HiLogger and measurement object are connected to different mains circuits, or if an ungrounded power cord is used, the potential difference between the different grounding paths may result in current flow through a connection cable that could damage the measurement object or Memory HiLogger.
- The input voltage range limits are 0 to +10 V. If these limits are exceeded, the instrument could be damaged and personal injury or death could occur, so do not attempt measurement.

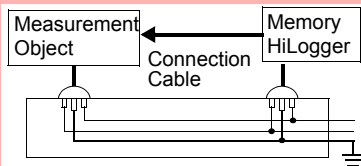

For safety, we recommend using only Hioki's connection cable (measurement lead cable).

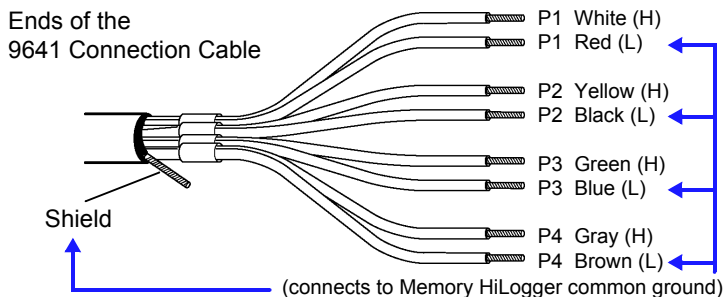

Connecting the Optional Model 9641 Connection Cable (for Pulse Signal Input)

Connect the optional 9641 connection cable to the pulse input connector.

Pulse Input Connector

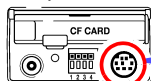

1

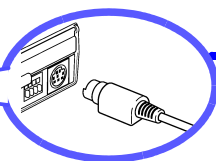

2

Connect the other end of the cable to the pulse source(s) to be measured.

2.4 Turning the Power On and Off



Using the AC Adapter

Before turning the instrument on, make sure the supply voltage matches that indicated on its power connector. Connection to an improper supply voltage may damage the instrument and present an electrical hazard.

Rated supply voltage is 100 to 240 VAC

(Voltage fluctuations of $\pm 10\%$ from the rated supply voltage are taken into account.)

Rated supply frequency is 50 or 60 Hz.

Turning Power On

Verify that the instrument and peripheral devices are correctly connected.

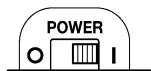

Turn the power switch on (I).



Right Side



Initial screen



The power supply icon appears near the bottom right corner of the screen (p. 19).

If the "  " indicator is not displayed, the instrument is not being powered from the AC line. In this state, the battery charge will be depleted if measuring for a long time, and measurement may be interrupted. Verify that the AC adapter is securely connected to an AC power source and to the instrument.

Execute zero-adjust 30 minutes after turning power on (p. 35).

Turning Power Off

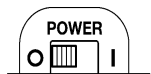

Turn the power switch off (O).

The installed battery pack is charged whenever the AC adapter is plugged into a power outlet, even when the Memory HiLogger is off. In addition, providing there is some remaining battery charge, waveform data and the setting configuration are memorized whenever the Memory HiLogger is turned off, so that when the Memory HiLogger is turned back on, the same operating state is displayed.

2.5 Zero Adjustment

Zero adjustment corrects for voltage offset at the input terminals, so that Memory HiLogger measurements are relative to zero volts.

Perform the zero adjustment procedure when using the instrument in a location where the ambient temperature is markedly different.

Turn on the power and wait for 30 minutes to stabilize the internal temperature of the Memory HiLogger.

- 1**  With the Waveform or [CH] screen displayed, press and hold these keys simultaneously for one second.

(simultaneously)

The Zero Adjust dialog appears.

- 2**  Select **[Zero Adjust]**.

 Apply

Zero adjustment is executed.

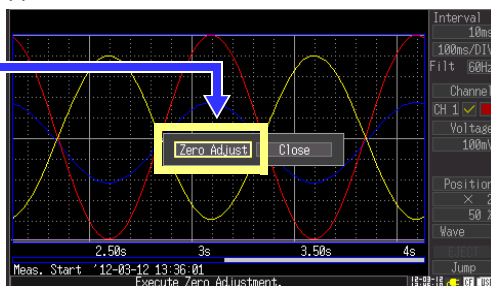

From the Setting screen

NOTE Any zero-adjust setting is cleared upon system reset (p. 125).

Setting before Measurement

Chapter 3

3.1 Pre-Operation Inspection

Before using the instrument the first time, verify that it operates normally to ensure that no damage occurred during storage or shipping. If you find any damage, contact your dealer or Hioki representative.

1 Peripheral Device Inspection

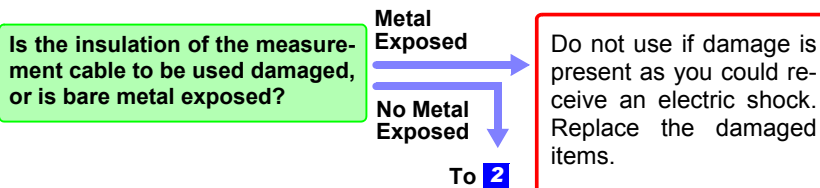

2 Instrument Inspection

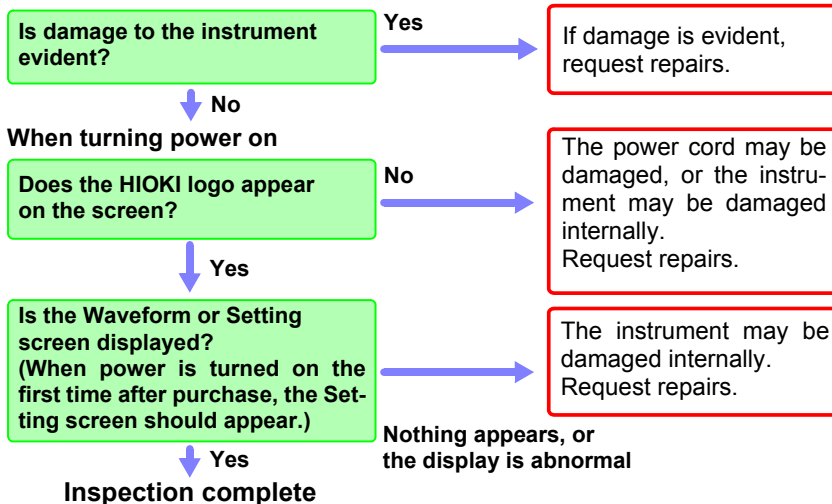

3.2 Operating Flow Overview

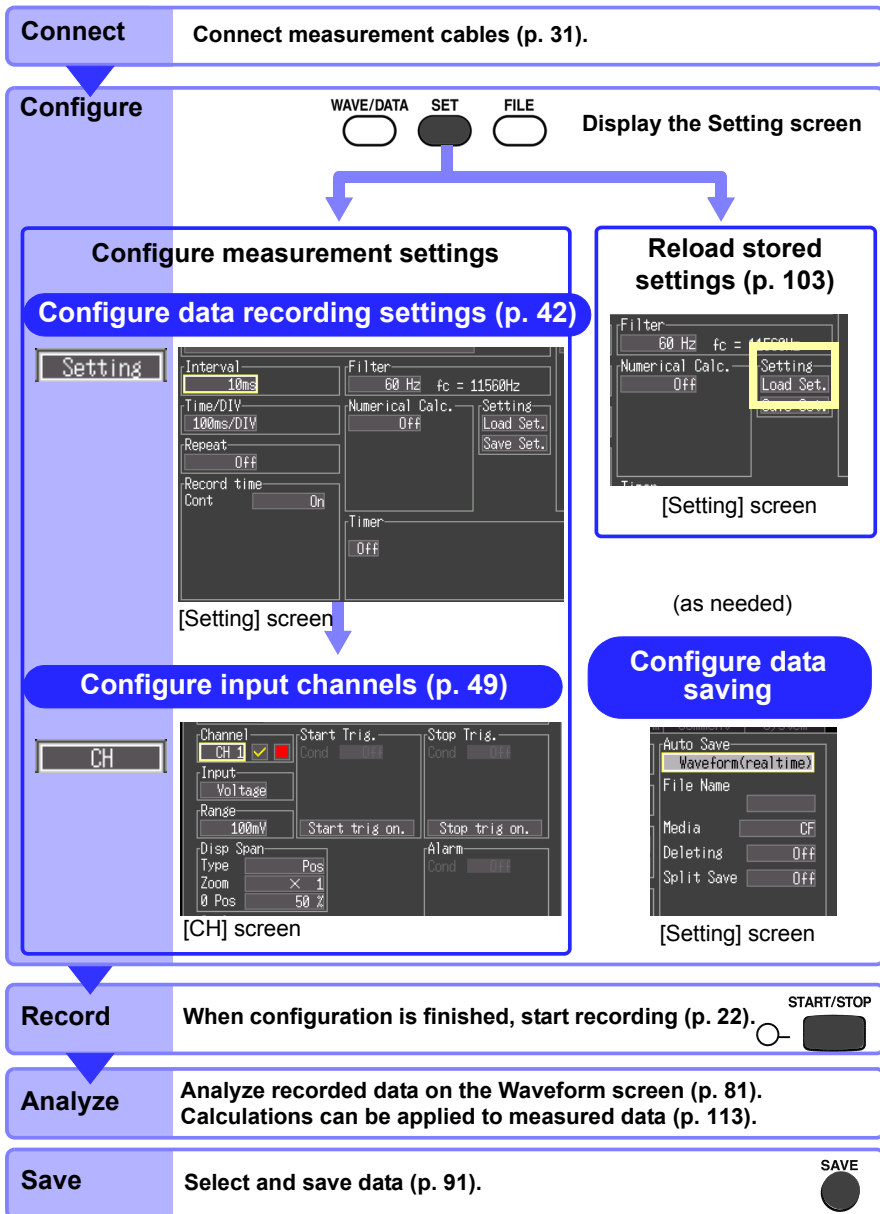

Measurement Configuration (Setting Screen)

Before measuring, configure the measurement settings on the [Setting] and [CH] screens. A brief operational description of the currently selected (high-lighted) setting item appears at the bottom of the screen.

Three recording methods are available. Timed recording, which record between specified start and stop times, can be used in combination with these methods (p. 76).

Recording Method	Description
Normal Recording	Records for the specified recording length beginning when measurement starts (Cont: Off).
Continuous Recording	Records continuously beginning when measurement starts (Cont: On).
Repeat Recording	Records repeatedly for the specified recording length (time span) (Repeat: On).

Configure recording settings: [Setting] screen

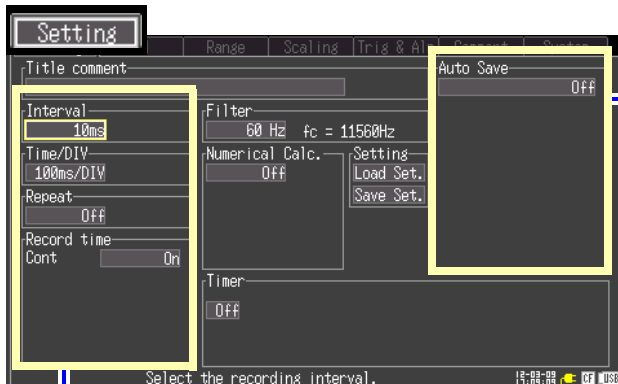

Make other settings as needed.

- Save automatically while measuring (p. 46)*
- Reloading Settings (p. 103)
- Saving Settings (p. 102)
- Enter a title for measurements (p. 60)
- Filter out noise (p. 45)
- Perform numerical calculations (p. 113)
- Record by timer (p. 76)*

*. Must be set before measuring.

Horizontal Axis (Time Axis) Settings

- Data recording (acquisition) interval (p. 42)*
- Display time base (time per horizontal division) (p. 43)
- Recording start/stop method (p. 44)*
- Recording length (time span) for repeated or one-time recording (p. 45)*

Configure input channel settings: [CH] screen

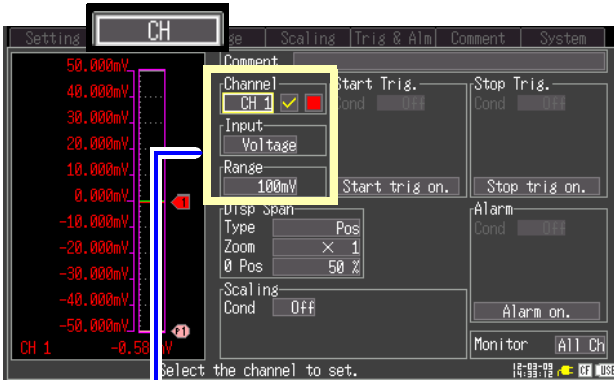
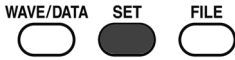

Input Channel Settings

- Voltage measurement (p. 50)
- Temperature measurement (p. 51)
- Integration (pulse count) (p. 53)
- Revolution measurement (p. 54)

Make other settings as needed.

- Entering channel comments (p. 60)
- Selecting channel display colors (p. 56)
- Setting the display range
 - Specifying the display position (p. 56)
 - Specifying upper and lower display limits (p. 57)
- Recording specific events (triggering) (p. 68)
- Setting alarm output (alarm function) (p. 73)
- Setting Unit Conversion (Scaling) (p. 58)
- Switching the monitor display (p. 24)

Measurement Configuration (Waveform Screen)

Certain setting items are available on the Waveform screen. Setting details are the same as for those on the Setting screen.

WAVE/DATA SET FILE



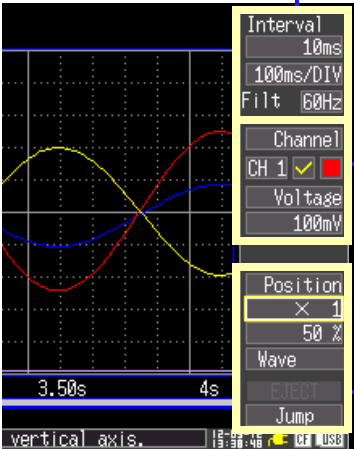

Waveform Screen

Horizontal Axis Settings

- Specify the recording interval (data acquisition interval) (p. 42)
- Specify the display time base (time per horizontal division) (p. 43)
- Enable digital filtering (noise suppression) (p. 45)

Input Channel Settings

- Voltage measurement (p. 50)
- Temperature measurement (p. 51)
- Integration (pulse count) (p. 53)
- Revolution measurement (p. 54)
- Alarm settings (p. 73)

Waveform Display Settings

- Setting the display range
- Specifying the display position (p. 56)
- Specifying upper and lower display limits (p. 57)
- Select the alarm display type (p. 84)
- Eject (replace the CF card/USB flash drive during real-time save operation)(p. 48)
- Displaying any point in time (Jump function) (p. 83)

About Channel Settings

Pressing the CH ▲/▼ keys selects channel setting and gauge display items. However, while measurement data is displayed, such changes affect only those channels selected (by a check mark [☑]).

3.3 Setting Configuration 1 – Recording Settings

Configure the horizontal axis and recording settings on the [Setting] screen. To save data while measuring, auto save must be enabled beforehand (p. 46).

1 WAVE/DATA SET FILE → Select the [Setting] screen.

2 → Move to a setting item.

↓
 → Open the setting options for the item to be set.

↓
 → Select from the listed options.

↓
 → Apply

The [Setting] screen shows the following options:

- Interval: 10ms
- Filter: 60 Hz fc = 11500Hz
- Time/DIV: 100ms/DIV
- Numerical Calc.: Off
- Repeat: Off
- Record time: On
- Cont.: Off
- Setting Load Set.
- Save Set.
- Auto Save: Off

select the recording interval.

Specify the Recording Interval

Select the data acquisition interval to suit your measurement objectives. Note that shorter recording intervals restrict the maximum recording time.

Select from the [Interval] setting options.

Setting options:

10ms*, 20ms, 50ms, 100ms, 200ms, 500ms, 1s, 2s, 5s, 10s, 20s, 30s, 1min, 2min, 5min, 10min, 20min, 30min, 1h (* default setting)

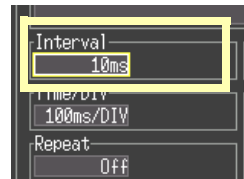

Broken wire detection is automatically disabled when the interval is set to 10, 20 or 50 ms (p. 51).

Some waveform peaks may not be displayable with certain interval settings.

For example, when the [Interval] is 1 s and the [Time/ DIV] (time base) is 5 s.

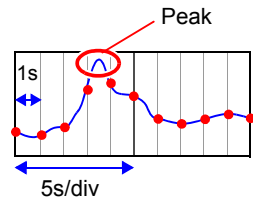

Setting the Display Time Base (horizontal axis magnification, set as needed)

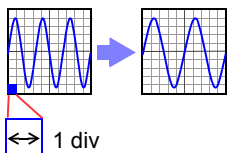

Displayed waveforms can be expanded or compressed along the horizontal axis. Shorter setting values correspond to greater magnification. This setting can be changed both during and after measurement without affecting acquired data (p. 83).

Select from the [Time/DIV] setting options.

Setting options:

- 100ms*, 200ms, 500ms, 1s, 2s, 5s, 10s, 20s, 30s,
- 1min, 2min, 5min, 10min, 20min, 30min, 1h, 2h, 5h,
- 10h, 12h, 1day [DIV] (* default setting)

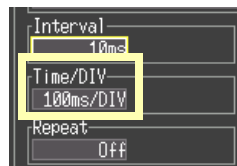

When auto save is enabled for waveforms, 100, 200 and 500 ms settings are automatically changed to 1 s when measurement starts, and the shorter values cannot be selected while measuring.

Available display time base settings depend on the selected recording interval. Horizontal axis display options are affected when the recording interval is changed after measuring, because the options for expanding (or compressing) the displayed axis depend on the recording interval used when measuring.

●: Selectable, ×: Not selectable, △: Not selectable while measuring

Horizontal axis	Recording interval																		
	[ms]						[s]						[min]				[h]		
	10	20	50	100	200	500	1	2	5	10	20	30	1	2	5	10	20	30	1
100ms	●	●	●	×	×	×	×	×	×	×	×	×	×	×	×	×	×	×	×
200ms	●	●	●	●	×	×	×	×	×	×	×	×	×	×	×	×	×	×	×
500ms	●	●	●	●	×	×	×	×	×	×	×	×	×	×	×	×	×	×	×
1s	●	●	●	●	●	●	×	×	×	×	×	×	×	×	×	×	×	×	×
2s	●	●	●	●	●	●	●	×	×	×	×	×	×	×	×	×	×	×	×
5s	●	●	●	●	●	●	●	×	×	×	×	×	×	×	×	×	×	×	×
10s	●	●	●	●	●	●	●	●	●	×	×	×	×	×	×	×	×	×	×
20s	●	●	●	●	●	●	●	●	●	×	×	×	×	×	×	×	×	×	×
30s	●	●	●	●	●	●	●	●	●	×	×	×	×	×	×	×	×	×	×
1min	●	●	●	●	●	●	●	●	●	●	●	×	×	×	×	×	×	×	×
2min	●	●	●	●	●	●	●	●	●	●	●	●	×	×	×	×	×	×	×
5min	●	●	●	●	●	●	●	●	●	●	●	●	●	×	×	×	×	×	×
10min	●	●	●	●	●	●	●	●	●	●	●	●	●	●	●	×	×	×	×
20min	●	●	●	●	●	●	●	●	●	●	●	●	●	●	●	●	×	×	×
30min	●	●	●	●	●	●	●	●	●	●	●	●	●	●	●	●	×	×	×
1h	●	●	●	●	●	●	●	●	●	●	●	●	●	●	●	●	●	●	×
2h	△	●	●	●	●	●	●	●	●	●	●	●	●	●	●	●	●	●	●
5h	△	△	●	●	●	●	●	●	●	●	●	●	●	●	●	●	●	●	●
10h	△	△	△	●	●	●	●	●	●	●	●	●	●	●	●	●	●	●	●
12h	△	△	△	●	●	●	●	●	●	●	●	●	●	●	●	●	●	●	●
1day	△	△	△	△	●	●	●	●	●	●	●	●	●	●	●	●	●	●	●

3.3 Setting Configuration 1 – Recording Settings

Selecting the Recording Start/stop Method

Start Measurement Stop Measurement

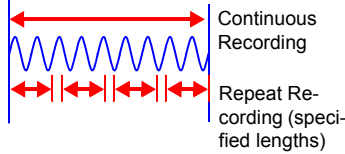

Specify how you want recording to start and stop. The following methods are available.

- Record continuously: Record continuously between starting and stopping measurement.
- Specified length (time span): Record only for a specified time span (can be set to automatically repeat) (p. 45)

To record continuously, Enable continuous recording (set [Cont] to [On]). (default setting)

Recording continues until you press the **START/STOP** key, or until a “stop trigger” event occurs.

When auto save is enabled for measurement data, the saving method depends on whether [Deleting] or [Split Save] (segmented save) is selected (p. 46).



To record for a specified length (time span),

- 1 Set [Cont] to [Off].
- 2 Specify the duration of one recording length (time span).

Setting options:

d (days) 0 to 499, h (hours) 0 to 23,
min (minutes) 0 to 59, s (seconds) 0 to 59

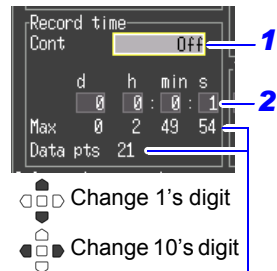

Recording proceeds for the specified length. Recording stops early if you press the **START/STOP** key before the recording length has elapsed, or if a “stop trigger” event occurs.

Maximum recording length and data samples

Indicates the maximum recording time to internal memory, and the maximum number of data samples. These values are limited by the specified recording length and the number of measurement channels used.

See: Appendix 6, “Maximum Recordable Time” (p. A11)

Set the Recording Length for Repeated or One-time Recording

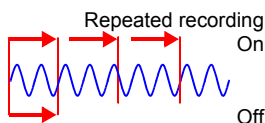

Select whether recording should be resumed after the specified recording length has elapsed or after recording is stopped by a “stop trigger” event.

Select from the [Repeat] setting options.

Setting options: (* default setting)

- Off*** Recording stop after one recording length (time span).
- On** Recording restarts after the specified recording length has elapsed or after recording is stopped by a “stop trigger” event. To manually stop recording, press the **START/STOP** key.

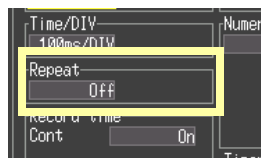

When repeating recording is enabled ([Repeat] set to [On]) After a recording length has elapsed, some “dead time” is needed for internal processing before recording can resume.

Because recording is not available during the dead time, enable continuous recording (set [Cont] to [On]) if you need to record without data loss.

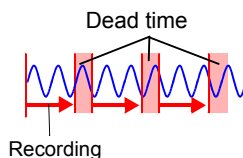

Enable Digital Filtering (noise suppression) (as needed)



Electrical noise mixed with input signals can be removed by digital filtering. Noise suppression is most effective for longer recordings, where it can provide higher measurement accuracy and less scattering. Set as needed to suit your measurement environment.

See: “Cut-off frequency” (p. 141)

Select from the [Filter] setting options.

Setting options: **60Hz***, **50Hz**, **Off** (* default setting)

When disabled (set to Off), broken wire detection is also disabled (p. 51).

When the 60 Hz digital filter is selected, optimum line noise suppression occurs when the recording length is between two seconds and one hour.

Noise is suppressed with either 50 Hz or 60 Hz filter selections, although the measurement timing difference between channels may be increased, depending on the recording length. Disabling the filter (set to Off) minimizes such timing differences (to less than 1 ms between channels).

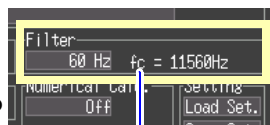

fc: cut-off frequency

Automatic Saving

Measurement data can be automatically saved to a CF card or USB flash drive while measuring.

The available types and formats of automatically saved data are as follows.

Saved Content	Setting	File Extension	Description
Waveform data only	Waveform (realtime)	.MEM	Waveform data is saved to the CF card while recording.
	CSV (realtime)*2	.CSV	Waveform data is saved in CSV text format while recording. Saved data cannot be reloaded in the HiLogger.
Calculation results only *1	Calc (post meas.)	.CSV	After recording, calculation results are saved to the CF card. When [Repeat] is enabled ([On]), calculation results for each recording are included in the recorded data file.
Waveform data and calculation results *1	Waveform + Calc	.MEM, .CSV	Waveform data is saved while recording, and calculation results are saved when recording finishes.
	CSV + Calc*2	.CSV, .CSV	Waveform is saved in CSV text format while recording, and calculation results are saved when recording finishes. Saved data cannot be reloaded in the HiLogger.

*1. Numerical calculation settings must be made before starting recording (p. 113).

*2. The [CSV (real time)] and [CSV + Calc] settings are not available when the record interval is 10ms or 20ms. Also, when opening a CSV file in a spreadsheet program, note that the number of rows that can be loaded at one time is limited (p. A7).

1 Select which content to save from the [Auto Save] settings.

Setting options: **Off***, **Waveform(realtime)**, **CSV(realtime)**, **Calc(post meas.)**, **Waveform + Calc**, **CSV + Calc** (* default setting)

When [**Waveform(realtime)**], [**CSV(realtime)**], [**Waveform + Calc**], [**CSV + Calc**] is selected

2 (As needed) You can enter a file name for the waveform files.

See: 3.6, "Entering Comments" (p. 60)

If left blank, file names are created automatically.

See: Appendix 2, "File Naming" (p. A7)

3 Select the removable storage priority (CF card or USB flash drive)

4 Select the [Deleting] method for saving data when the CF card or USB flash drive becomes full.

Setting options:(* default setting)

Off* Saving stops when the CF card or USB flash drive becomes full.

On When space on the CF card or USB flash drive declines to a certain level when starting or during automatic saving, the oldest file is deleted. If the file cannot be deleted, saving stops. Only waveform files can be deleted in this way. Appendix 2, "File Naming" (p. A7)

5 Select whether to create a new file for each recording length, or to create new files at specified intervals (using [Split Save]).

Setting options:(* default setting)

Off* One file is created for each recording length.

On Specify the length (time span) of saved segments. A measurement data file is created for each segment.

Ref Time Specify a reference time and segment length (time span). A file is saved after each segment time span beginning at the reference time.

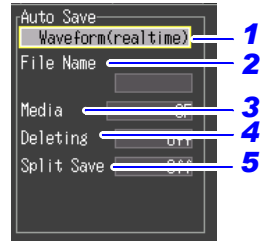

Horizontal axis settings are inhibited during automatic saving of waveforms (p. 43).

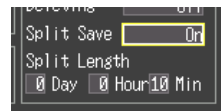

[Split Save: On]

Segment length: Days (0 to 30), Hours (0 to 23), Minutes (0 to 59)

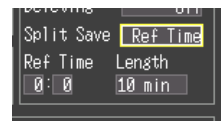

[Split Save: Ref Time]

Ref Time (reference time):

0:0 to 23:59

Length (Segment length):

1, 2, 5, 10, 15, 20, 30 minutes,
1, 2, 3, 4, 6, 8, 12 hours, 1day

When starting measurement, the message "Sync fixed time" is displayed until the recording interval synchronizes with specified reference time.

NOTE

Regardless of the split save setting, the file will be automatically split when the file size nears 2 GB.

Replacing Removable Storage During Real-Time Saving

During real-time saving, removable storage can be replaced without interrupting measurement. This procedure describes replacing a USB flash drive.

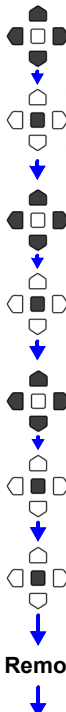

Move the cursor to [EJECT].



Right bottom of the screen

Execute

Move the cursor to [Unmount USB memory].

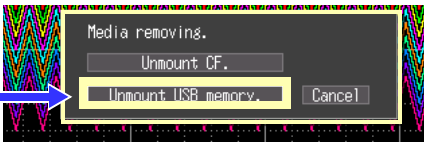

Execute

Move the cursor to [Yes].



Execute

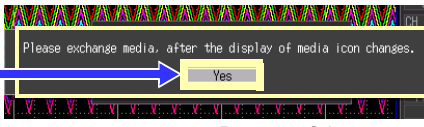

Bottom of the screen

Remove the USB flash drive (p. 94)

Insert a formatted removable storage.

Measurement data acquired while the device was removed is automatically written.*

See: Formatting: (p. 95)
Insertion: (p. 94)

When both a CF card and USB flash drive are installed and either is removed, the save destination automatically switches to the remaining media.

NOTE

- If a storage device is not replaced within two minutes after selecting "Yes" in the "Do you want to remove the USB memory/CF card?" confirmation dialog, data may overflow internal memory and be lost.
- If a storage device is replaced during real-time saving, data is saved to a new file.
- If measurement ends while the removable storage is ejected, even if a removal storage is then inserted, the remaining data is lost. If this occurs, the measurement data remaining on the instrument can be retrieved with the manual save function.
See: 6.3, "Saving Data" (p. 96).

3.4 Setting Configuration 2 – Input Channel Settings

Configure the input channel settings on the [CH] screen. You can make these settings while viewing input signal amplitude on the level monitor.

There are two general types of input signals, analog channels CH1 – CH10 and pulse channels P1 to P4. The analog channels can be used to measure voltage and temperature (with thermocouples), and the pulse channels can be used for pulse counting (integration) and revolution measurement.

Analog channels	Pulse channels
"Voltage Measurement Settings" (p. 50)	"Integration (Count) Measurement Settings" (p. 53)
"Temperature Measurement Settings" (p. 51)	"Revolution Measurement Settings" (p. 54)

Settings can be changed while viewing all channel settings on the [Range], [Scaling], [Trig & Alm], and [Comment] screens.

In this example, settings are made on the [CH] screen while viewing the level monitor.

You can specify recording criteria with the input settings to control recording, or to output alarm signals. See Chapter 4, "Specifying Criteria for Measurements (Triggering, Alarm and Timer)" (p. 67) for details.

1 WAVE/DATA SET FILE

Select the [CH] screen.

2 Move to a setting item.

Open the setting options for the item to be set.

Select from the listed options.

Apply

Level monitor (p. 24)

Use the CH ▼/▲ keys to change the selected channel.

Voltage Measurement Settings

Configure these settings for each voltage measurement channel.

- 1** Select a channel (**CH 1** to **CH 10**) for the **[Channel]** setting contents.
- 2** To enable measurement on the channel, select **On** to display the check mark (☑).
- 3** Select **[Voltage]** for the **[Input]** (input type) setting.
- 4** Select the appropriate measurement amplitude range for the **[Range]** setting.

Setting options:

100mV*, **1V**, **10V**, **20V**, **100V**, **1-5V**

(* default setting)

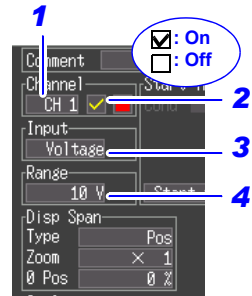

Instrumentation and Control Device Measurements

For instrumentation control signal measurements, select **[1-5 V]**. This range corresponds to the 4-20 mA output standard for instrumentation control. This setting automatically sets 1- and 5-volt lower and upper limits, respectively, in the 10 V range. Measurement accuracy is $\pm 10 \text{ mV} \pm 5 \text{ mV}$. To measure 4-20 mA current, connect a 250Ω shunt resistor between + and – analog input terminals (p. 32).

Use the scaling function to scale measurements to any arbitrary unit value for display (p. 58).

Temperature Measurement Settings

Configure these settings for each temperature measurement channel.

1 Select a channel (**CH 1** to **CH 10**) for the **[Channel]** setting contents.

2 To enable measurement on the channel, select **On** to display the check mark (☑).

3 Select **[Tc]** for the **[Input]** (input type) setting.

4 Select the type of thermocouple to be used.

Setting options:

K*, J, E, T, N, R, S, B (* default setting)

5 Enable or disable **[Burn Out]**.

Setting options:(* default setting)

Off* Do not detect broken (disconnected) wires.
Normally when the thermocouple is disconnected, the value will fluctuate, etc. and will not be stable.

On Detect broken wires.
(This setting is available only when the recording interval is at least 100 ms, and the 50 Hz or 60 Hz digital filter is enabled.)
When the wires are disconnected, "OVER" will be displayed as the measurement value.

6 Select the reference junction compensation (**RJC**) method for the **[RJC]** setting.

Setting options:(* default setting)

Int* Use the Memory HiLogger's internal compensation. Measurement accuracy is the sum of the temperature measurement accuracy and the RJC accuracy.

Ext Use an external RJC method instead of the Memory HiLogger's internal compensation. Memory HiLogger measurement accuracy is equivalent to the temperature measurement accuracy.

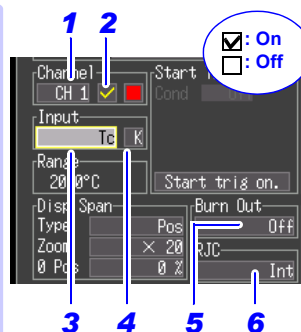

Temperature Measurement Range
(Depends on thermocouple type)

K	-200°C to 1350°C
J	-200°C to 1200°C
E	-200°C to 1000°C
N	-200°C to 1300°C
T	-200°C to 400°C
R	0°C to 1700°C
S	0°C to 1700°C
B	400°C to 1800°C

JIS C 1602-1995

With type B, the display shows 0 to 400°C, but accuracy is not guaranteed.

3.4 Setting Configuration 2 – Input Channel Settings

About Burn Out Detection

Broken (disconnected) thermocouple wires are detected using a tiny (300 nA) sensing current. The thermal equivalent of the thermoelectromotive force (thermocouple resistance (Ω) times the 300 nA sensing current) is added to the measured value. However, measurement errors can occur if the thermocouple wire is long or if the wire itself has a large resistance, in which cases broken wire detection should be disabled (set to Off).

If Thermocouple Measurement Range is Exceeded

Example: Using a type T thermocouple with range -200 to +400°C
When measurements are outside of the range of the thermocouple, the waveform saturates and clings to the top of the screen as shown at the right.

The numerical measurement values are displayed as "OVER" and the cursor measurement value, calculation values and saved data are handled as full-scale output values of the 16-bit A/D converter.

See: "LR8431-20 Measurement Values" (p. A12)

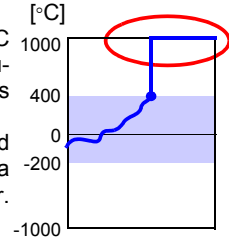

Integration (Count) Measurement Settings

Configure these settings for each pulse channel receiving input from a pulse output device such as a watt-hour or flow meter.

Use the scaling function to display integrated pulse counts as the corresponding physical units (such as Wh or VA) of the measurement parameter (p. 58).

1 Select a channel (P 1 to P 4) for the [Chan- nel] setting contents.

2 To enable measurement on the channel, select On to display the check mark (☑).

3 Select [Count] for the [Input] (input type) setting.

4 Select the measurement method from the [Count Mode] settings.

Setting options:(* default setting)

Add* Counts the number of pulses acquired from the start of measurement.

Inst Counts the number of pulses acquired during each recording interval. The pulse count is reset at the beginning of each recording interval.

5 Select the basis of measurement from the [Slope] settings.

Setting options:(* default setting)

↑* Counts the number of L - H transitions.

↓ Counts the number of H - L transitions.

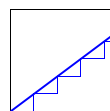
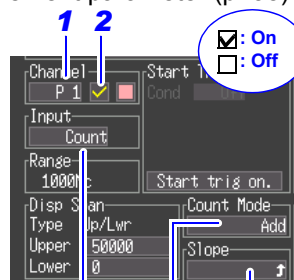

Totalized
[Add]

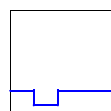

Instantaneous
[Inst]

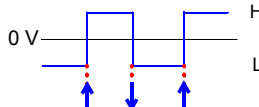

NOTE

- When using the scaling function, the integrated pulse count can be displayed after conversion to the measurement target's property (Wh, VA, etc.). (p. 58)
- The count will be saturated when the pulse count exceeds 1,073,741,823. If there is a possibility that this number may be exceeded, it is recommended to set the integration mode to instantaneous and tabulate the results later with Excel® or a similar application.

Revolution Measurement Settings

Configure these settings for each pulse channel on which you will be counting pulses corresponding to revolutions, such as output from a rotary encoder or tachometer. The revolution measurement is obtained by counting the number of pulses input per second. The scaling function can be used to display the results of converting measured values to physical properties of the measurement target. (p. 58).

1 Select a channel (P 1 to P 4) for the [Channel] setting contents.

2 To enable measurement on the channel, select On to display the check mark (☑).

3 Select [Revolve] for the [Input] (input type) setting.

4 Set the [Pulse/Rev] setting to the number of pulses per revolution.

Setting options: 1* to 1000 (* default setting)

The range is automatically determined by this setting.

5 Select the basis of measurement from the [Slope] setting.

Setting options:(* default setting)

↑* Counts the number of revolutions based on L - H transitions.

↓ Counts the number of revolutions based on H - L transitions.

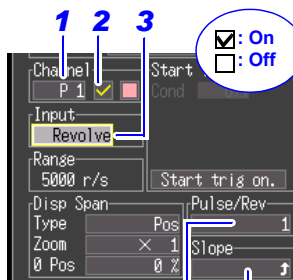

- Change 1's digit
- Change 10's digit
- 5000 r/s (n=1)

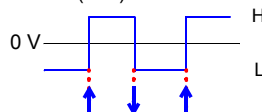

Revolution Measurement Theory

Pulse count is measured using the Memory HiLogger's internal 10 ms sampling interval.

The revolution rate (r) per second during time t_s is obtained by dividing the number of pulses from $(t-1)$ to t_s by the number of pulses per revolution.

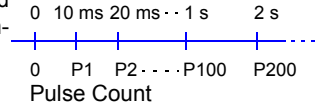

$$r [\text{rps}] = \frac{\text{Pulse count at } t_s \text{ minus pulse count at } (t-1)_s}{\text{Pulses per revolution}}$$

(rps: Revolutions per second)

Example: Pulses per revolution = 4

When the number of pulses counted in one second is $P_{100} = 1000$ c,

and the number of pulses counted in two seconds is $P_{200} = 2000$ c,

then the revolution rate (rps) at $t=2$ s ($r_{t=2}$) can be obtained.

$$r_{t=2} = \frac{2000 - 1000}{4} = 250 [\text{rps}]$$

When time t_s is less than one second

The pulse count at $(t-1)_s$ (whole seconds) cannot be measured, so 100 times the pulse count between $(t-0.01)_s$ and t_s serves and the pulse count for one second to obtain the revolution rate.

As a result, revolution measurements when t is less than one second are scattered.

$$r [\text{rps}] = \frac{\text{Pulse count at } t_s \text{ minus pulse count at } (t-0.01)_s}{\text{Pulses per revolution}} \times 100$$

3.5 Display Settings

Configure how each channel is displayed, as needed. These settings can be changed on the Numerical/Waveform screen after measurement.

Selecting Waveform Display Color

Different display colors can be selected for each input channel waveform.

Select from the waveform display color setting options.

Setting options: Off (x), 24-color

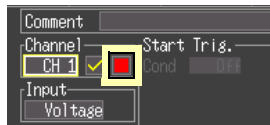

Specifying Vertical Display Range by Magnification and Zero Position (vertical axis expansion/compression)

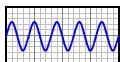

Normal Display

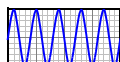

Magnified Display (x2)

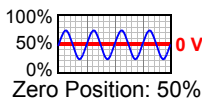

Zero Position: 50%

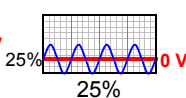

25%

The vertical display range and zero position can be specified for each channel.

The magnification setting determines the displayed range. Waveforms are expanded or compressed vertically relative to the center of the screen.

Magnification and zero-position settings are ignored when the display range is defined by upper and lower limits.

In the 1-5V range of a voltage measurement and in integration measurement, [Position] cannot be specified.

1 Select [Position] for the [Type] setting options.

2 Select from the [Zoom] setting options.

Setting options:

x100, x50, x20, x10, x5, x2, x1*, x1/2

(* default setting)

3 Set the desired zero position [0 pos] as a percentage of screen height.

Setting options:

-50 to 150% (with x1 magnification)

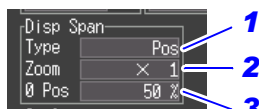

Change 1's digit

The expansion/compression range depends on the selected magnification.

Default Setting

Input type	Zoom	Zero position	Input type	Zoom	Zero position
Voltage	x1	50	Integration (Count)	—	—
Temperature (Tc)	x20	0	Revolution (Revolve)	x1	0

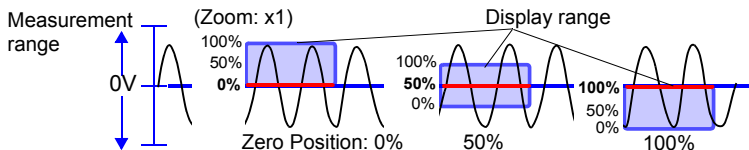

Specifying the Vertical Display Range by Upper and Lower Limits (expansion/compression)

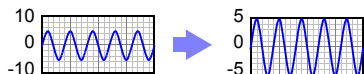

The vertical display range can be defined by upper and lower limits.

Using this method, the voltage range does not need to be selected because the optimum range is selected automatically for the display. However, upper and lower limit settings are ignored when magnification and zero position are enabled to define the display range.

As the upper and lower limits in the 1-5V range are fixed, they cannot be changed.

1 Select **[Upper/Lower]** for the **[Type]** setting item.

2 Specify the **[Upper]** value for the top of the display.

3 In the same way, specify the **[Lower]** value for the bottom of the display.

The display range and scaling settings are interlinked.

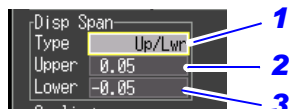

After making the settings, press **[OK]**.

Default Setting

Input type	Range
Voltage	-50m to 50m
Temperature (Tc)	0 to 100
Integration (Count)	0 to 5000
Revolution (Revolve)	0 to 5000

The range is not automatically optimized when the upper and lower limits are set on the waveform screen.

Converting Units (Scaling function)

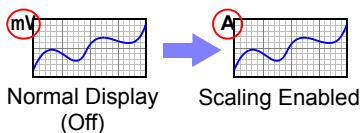

Use the scaling function to convert input voltage to the physical units of the measurement parameter for display, such to convert voltage input for display as electrical current. Converted values can be displayed in fixed- or floating-point notation.

Setting Analog Channel or Pulse Channel (Revolution) Scaling

1 For the [Cond](condition) setting, select the desired numerical notation.

Setting options:(* default setting)

Dec Displays converted values using fixed-point notation

Exp Displays converted values using floating-point notation

Off* Scaling is disabled.

2 Move to the next item to the right, and select the scaling method.

Setting options:(* default setting)

Ratio* Convert by specifying the ratio of physical units per volt of input signal (conversion ratio), offset, and the name of the units.

2-pt Convert by specifying the input signal voltage at two points, the physical unit values at those points, and the name of the units.

3 Enter the [Unit] name on the comment entry screen.

See: 3.6, "Entering Comments" (p. 60)

4 **Ratio:** Enter the conversion ratio and offset.
2-pt: Enter the values at two points before and after conversion.

[Cond: Dec]



4 Conversion Ratio Setting

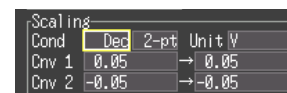

2-Point Setting

[Cond: Exp]

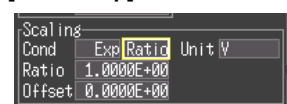

Conversion Ratio Setting



2-Point Setting

Conversion Ratio Setting Method

2-Point Setting Method

Units (eu)

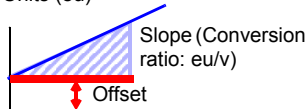

Converted unit values

Example

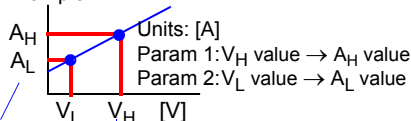

Actual measurement values (input values)

V_H : High value
 A_H : Converted high value
 V_L : Low value
 A_L : Converted low value

Combining scaling and display positioning (upper/lower limits)

To use both scaling and upper/lower display limits, set the scaling first, then upper/lower limit values. With scaling enabled, the upper and lower limit setting ranges are constrained as follows:

$-9.9999\text{E}+19 \leq \text{Setting value} \leq -1.0000\text{E}-19$, Setting value = 0,

$+1.0000\text{E}-19 \leq \text{Setting value} \leq +9.9999\text{E}+19$

Setting Pulse Channel (Integration) Scaling

Integrated pulse values can be converted for display as physical units of the measurement parameter (such as Wh or VA).

Pulse output devices determine the amplitude per pulse in physical units, or the number of pulses per fundamental unit (for example, per kWh, liter or m³).

1 For the [Cond] (condition) setting, select the desired numerical notation.

Setting options: (* default setting)

Dec Displays converted values using fixed-point notation

Exp Displays converted values using floating-point notation

Off* Scaling is disabled.

2 Enter the [Unit] name on the comment entry screen.

See: Entering Comments (p. 60)

3 Specify the physical units per pulse or the number of pulses per fundamental unit (for example, if 1 c = 1 pulse, select [1 pulse]). The settings for physical units per pulse and pulses per fundamental unit are interlinked.

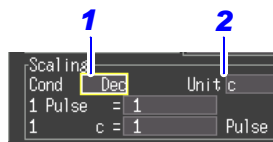

Using fixed-point notation

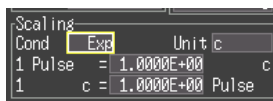

Using floating-point notation

Scaling Setting Example

For integration with a 50,000 pulse/kWh watt-hour meter:

Cond: Dec

Units: kWh

1kwh=50000 pulse

For integration with a 10 liter/pulse flow meter:

Cond: Dec

Units: L

1 pulse=10L

3.6 Entering Comments

Comments of up to 40 characters can be entered as a title for the measurement data, and as a label for each input waveform.

Titles and comments are displayed on the waveform screen (Comments appear only when [Value+Cmnt] display is selected).

Titles can be entered on the [Setting] and [Comment] screens, and comments can be entered on the [CH] and [Comment] screens. This description enters a comment on the [CH] screen.

1  Select the [CH] screen.

2  Select the field to enter the comment.

 Apply
The character entry screen appears.

3  Select the characters to enter
To enter a space, select a blank character.

 Apply
Characters appear in the entry field as you select them.

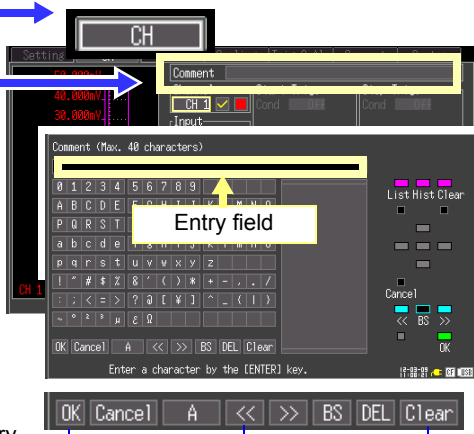







Finished with entry Navigate the entry field

Select **[OK]**

Accepts your entry and returns to the [Comment] screen.

The following characters are converted as follows when saved to a text file.

Entered character						
Converted plain text equivalent	^2	^3	^u	~o	~c	~e

Operating Panel

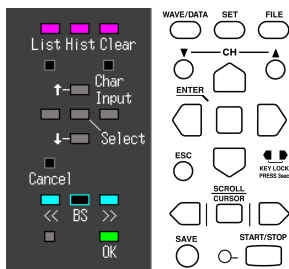

The operating panel depicts the functions of Memory HiLogger's operating keys.

Only the keys displayed on the operating panel are enabled.

- **List** (**WAVE/DATA** key)
Measurement related terms are registered in the list beforehand.
- **Hist** (History, **SET** key)
You can select previously entered terms from the pick list.
- **Clear** (**FILE** key)
Clears all entered characters.
- **Char Input** (**CH▲** key)
Switches between the pick list and character selection frames.
- **▲/▼** (Cursor up/down key)
Selects from the pick list frame.
- **Select** (**ENTER** key)
Accepts the item selected in the pick list.
- **Cancel** (**ESC** key)
Cancels entry.
- **<</ >>** (**SCROLL/CURSOR** left/right key)
Move input position.
- **BS** (**SCROLL/CURSOR** middle key)
Deletes one character.
- **OK** (**START/STOP** key)
Accepts entry.

3.7 Viewing All Channel Settings in a List

All channel settings can be viewed and changed in the list. You can copy batches of settings between channels.



[Range] screen

Setting	CH	Range	Disp	Zoom/Lower	Trig & Alm	Comment	System
Batch Proc	Input						Burn Out RJC
CH 1	Voltage	100mV	Pos	× 1	50 %		
CH 2	Voltage	100mV	Pos	× 1	50 %		
CH 3	Voltage	100mV	Pos	× 1	50 %		
CH 4	Voltage	100mV	Pos	× 1	50 %		

[Scaling] screen

Setting	CH	Range	Scaling	Trig & Alm	Comment	System
Batch Proc	Convert	Conversion Set 1	Conversion Set 2	Unit		
CH 1	Dec Rat	Ratio	2	Offset	0	A
CH 2	Dec Rat	Ratio	10	Offset	0	m/s ²
CH 3	Dec 2-pt	0 → 0	10	100	3	Pa
CH 4	Dec Rat	Ratio	5	Offset		V

Input Types

(: Voltage, : Temperature, : Integration, : Revolution, : Alarm)

[Trig & Alm] screen

Setting	CH	Range	Scaling	Trig & Alm	Comment	System
Batch Proc	Start	Stop	Alarm	Trigger		
CH 1	Level	Off	Off	Trig Func	On	
CH 2	Off	Off	Level	Timing	Start/Stop	
CH 3	Off	Off	Off	Trig Source		
CH 4	Off	Off	Off	Start	AND	

Input Types

(: Voltage, : Temperature, : Integration, : Revolution, : Alarm)

[Comment] screen

Setting	CH	Range	Scaling	Trig & Alm	Comment	System
	Title					
	Analog CH1	TEST1				
	CH2	TEST2				
	CH3	TEST3				
	CH4	TEST4				
	CH5	TEST5				

Batch Copying Channel Settings

The CH1 and P1 channel settings can be copied to other channels.

- 1** Select the screen showing the channel to copy. [Range], [Scaling], [Trig & Alm]

- 2** Select **[Batch Proc]**.

Apply

The selected items are displayed.

- 3** Select the desired action.

- **[Copy settings of CH1 to all other analog channels]** : Copy the settings from channel 1 to channels 2 through 10.
- **[Copy settings of P1 to all other pulse channels]** : Copy the settings from channel P1 to channels P2 through P4.

Apply

Settings	CH	Range	Scaling	TRIG
Batch Proc	Input	Range	Disp	Zoom/Lower
CH 1	Voltage	100mV	Pos	× 1
CH 2	Voltage	100mV	Pos	× 1
CH 3	Voltage	100mV	Pos	× 1
CH 4	Voltage	100mV	Pos	× 1
CH 5	Voltage	100mV	Pos	× 1

Select command
Reset all settings in this page
Copy settings of CH1 to all other analog channels
Copy settings of P1 to all other pulse channels
Put all analog channels in order 5%
Put all analog channels in order 10%

Except for the following, the settings displayed on the screen are copied.

- Waveform display color
- Input type (although this can also be copied from the [Range] screen, p. 62)

Batch Setting Waveform Display/Hide and Waveform Color Settings for All Channels

The display of all waveforms can be hidden, and all waveform display colors can be set to defaults.

This setting is only available on the [Range] screen.

- 1** Select **[Batch Proc]**.

Apply

The selected items are displayed.

- 2** Select the desired action.

Apply

Settings	CH	Range	Scaling	TRIG
Batch Proc	Input	Range	Disp	Zoom/Lower
CH 1	Voltage	100mV	Pos	× 1
CH 2	Voltage	100mV	Pos	× 1
CH 3	Voltage	100mV	Pos	× 1

Put all analog channels in order 5%
Put all analog channels in order 10%
Set all analog channels color off
Set all analog channels color default

- **[Set all analog channels color off]**: Sets all channel waveforms to be hidden.
- **[Set all analog channels color default]**: Sets all channel waveform colors to their defaults.

3.7 Viewing All Channel Settings in a List

Initializing Settings (to factory defaults)

All settings in the current window are reset to their factory default values.

1 Select which screen you want to initialize, from the [Range], [Scaling], [Trig & Alm] screens.

2 Select [Batch Proc].
 Apply
 The selected items are displayed.

Settings	CH	Range	Scaling	Trig
Batch Proc	Input	Range	Disp	Zoom/Lower
CH 1	✓ Voltage	100mV	Pos × 1	
CH 2	✓ Voltage	100mV	Pos × 1	
CH 3	✓ Voltage	100mV	Pos × 1	
CH 4	✓ Voltage	100mV	Pos × 1	
CH 5	✓ Voltage	100mV	Pos × 1	

3 Select [Reset all settings in this page].
 Apply

Select command
Reset all settings in this page
Copy settings of CH1 to all other analog channels
Copy settings of P1 to all other pulse channels

Aligning Zero Positions on the Grid

Analog channel waveforms can be positioned evenly along the vertical grid, with CH1 at the top. ([Range] screen only)

This functionality is valid only for channels with the same input time as CH1 and for which [Display range] has been set to [Setting: Position].

CH1 to CH10 waveforms can be displayed together with each allotted 5% or 10% of the screen height.

This setting is only available on the [Range] screen.

1 Select [Batch Proc].
 Apply
 The selected items are displayed.

Settings	CH	Range	Scaling	Trig
Batch Proc	Input	Range	Disp	Zoom/Lower
CH 1	✓ Voltage	100mV	Pos × 1	
CH 2	✓ Voltage	100mV	Pos × 1	
CH 3	✓ Voltage	100mV	Pos × 1	

2 Select the desired action.
 Apply

Copy settings of P1 to all other pulse channels
Put all analog channels in order 5%
Put all analog channels in order 10%
Set all analog channels color off

3.7 Viewing All Channel Settings in a List

Alignment Example (with CH1 zero-position aligned at 95% and occupying 10% of vertical screen height)

Channel Zero-position (%)

CH1	95
CH2	85
CH3	75
CH4	65
CH5	55
CH6	45
CH7	35
CH8	25
CH9	15
CH10	5

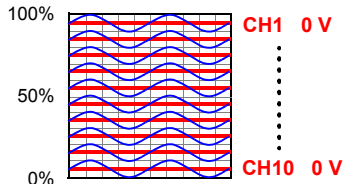

Display Celsius (°C) temperature values as Fahrenheit (°F)

All measured temperature values can be converted at once from Celsius to Fahrenheit units.

The conversion is simultaneously reflected appropriately on all scaled values. To revert from Fahrenheit units to Celsius, disable (set to Off) the scaling function (p. 58).

This setting is only available on the [Scaling] screen.

1 Select **[Batch Proc]**.

Apply
The selected items are displayed.

2 Select the desired action.

Apply

Specifying Criteria for Measurements (Triggering, Alarm and Timer) Chapter 4

You can set recording to start and stop under specific criteria (start/stop triggers), and to output alarm signals. You can also set specific times to start and stop recording, using the Timer function.

Triggering is the process of controlling the start and stop of recording by specific signals or conditions (criteria). When recording is started or stopped by a specific signal, we say the trigger is "applied" or "triggering occurs".

In this manual, **T** indicates a "trigger point", as the time at which a trigger is applied.

Trigger criteria met

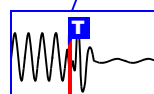

Criteria can be specified for the following event trigger types.

Trigger Type	Description	Setting Screen	Ref.
Start Trigger	Recording starts when the specified Start Trigger criteria are satisfied.	[CH]/ [Trig & Alm]	(p. 68)
Stop Trigger	Recording stops when the specified Stop Trigger criteria are satisfied. When [Repeat] is enabled (set to [On]), recording restarts automatically.	[CH]/ [Trig & Alm]	(p. 68)
Pre-trigger	Records data acquired during a specified period prior to each trigger event.	[Trig & Alm]	(p. 72)
Trigger Source	Various trigger criteria can be combined with logical AND/OR operations for each channel.	[Trig & Alm]	(p. 71)
External Trigger	Triggering can be applied by an external signal at the EXT.TRIG input terminal.	[Trig & Alm]	(p. 71)
Alarm	An alarm signal can be output when any specified criteria are met.	[CH]/ [Trig & Alm]	(p. 73)
Timer	Records at a specified date and time.	[Setting]	(p. 76)

Set trigger criteria for individual channels on the Channel [CH] screen, and set trigger and alarm settings for all channels on the [Trig & Alm] screen (p. 75).

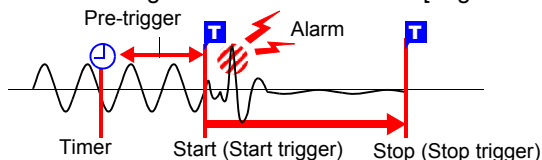

4.1 Setting Criteria to Start and Stop Recording

There are two ways to set the criteria to start and stop recording according to waveform slope.

Select whether to trigger at the rising or falling edge of the input signal.

Type of Analog Trigger	Trigger Example	Description
Level Trigger (p. 69) [Level]		Recording starts (or stops) when the input signal crosses the specified trigger level (voltage).
Window Trigger (p. 70) [In]		Recording starts (or stops) when the input signal enters a range defined by upper and lower thresholds.
[Out]		Recording starts (or stops) when the input signal exits a range defined by upper and lower thresholds.

Enable the Trigger Function

Select the trigger to use, and press the **ENTER** key. Press it again when the confirmation message appears, and you are ready to set trigger criteria (at the same time, the [Trigger] setting on the [Trig & Alm] screen turns on).

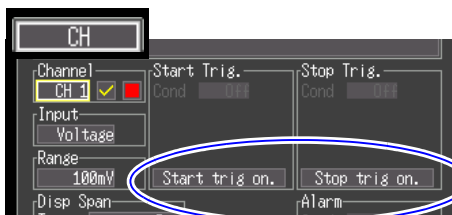

Set trigger criteria

Select the trigger criteria to be applied.



The [Timing] setting on the [Trig & Alm] screen determines the effect of triggering, as follows:

- Start recording upon trigger: [Start]
- Stop recording upon trigger: [Stop]
- Alternately start and stop upon trigger: [Start&Stop]

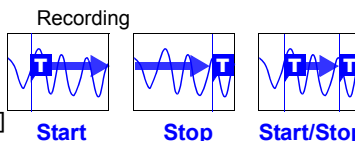

1 WAVE/DATA SET FILE → Select the [CH] Screen.

2 → Move to a setting item.

→ Open the setting options for the item to be set.

→ Select from the listed options.

→ Apply

Setting the Input Signal Trigger Threshold (Level Trigger)

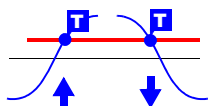

Enter the signal level threshold at which to start or stop recording, and whether triggering occurs on the upslope or downslope of the input signal.

Recording starts or stops when the signal crosses the specified threshold. The level value is an instantaneous (not rms) value.

Levels can be confirmed on the level monitor or on the Waveform screen.

1 Select [Level] as the [Cond] setting option for the start or stop trigger.

2 Select the input signal rising (↑) or falling (↓) edge setting option.

Setting options: (* default setting)

↑* Recording starts (or stops) when the signal crosses the threshold on the upslope (rising edge ↑).

↓ Recording starts (or stops) when the signal crosses the threshold on the downslope (falling edge ↓).

3 Set the [Level] setting to the input signal level at which to start or stop recording.

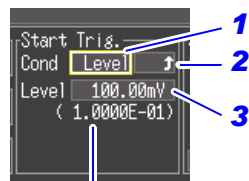

When scaling is enabled, the scaled value is also displayed.

Default setting: 0

Level Setting Ranges and Resolution

Channels	Input type	Range	Resolution	Channels	Input type	Range	Resolution
CH1 - CH10	Voltage	100mV	25 μ V	P1 - P4	Count	—	1 c
		1V	250 μ V		Revolve	—	1 r/s
		10V	2.5 mV				
		20V	5 mV				
		100V	25 mV				
		1-5V	2.5 mV				
	Tc	—	0.5°C				

4.1 Setting Criteria to Start and Stop Recording

Setting Lower and Upper Trigger Thresholds (Window Trigger)

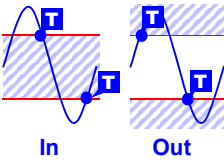

An input signal level “window” within which recording will (or will not) occur can be defined by upper and lower threshold levels. You can select whether recording starts or stops when the input signal level enters (In) or exits (Out) of this window.

Upper and lower thresholds can be verified in the level monitor or on the Waveform screen. When scaling is enabled, the scaled threshold values are displayed.

1 Select **[Window]** as the **[Cond]** setting option for the start or stop trigger.

2 Select inside **[In]** or outside **[Out]**.

Setting options: (* default setting)

In* Trigger when the input signal level enters the window defined by the upper/lower thresholds.

Out Trigger when the input signal level exits the window defined by the upper/lower thresholds.

3 Enter the upper threshold value for the **[Upper]** setting.

4 Enter the lower threshold value for the **[Lower]** setting.

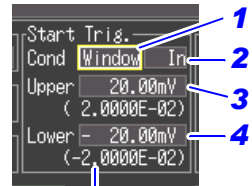

When scaling is enabled, the scaled value is also displayed.

Upper/Lower Threshold Ranges and Resolution

Channels	Input	Range	Resolution	Default setting	
				Upper	Lower
CH1 - CH10	Voltage	100mV	25 μ V	2 mV	-2 mV
		1V	250 μ V	20 mV	-20 mV
		10V	2.5 mV	0.2 V	-0.2 V
		20V	5 mV	0.4 V	-0.4 V
		100V	25 mV	2 V	-2 V
	1-5V	2.5 mV	0.2 V	-0.2 V	
	Tc	—	0.5°C	40°C	-40°C
P1 - P4	Count	—	1 c	80	0
	Revolve	—	1 r/s	80	0

Selecting Trigger Sources and Combinations

Enable the trigger function (set to On), select recording start/stop timing, and set trigger criteria. Triggering is affected only by those channels for which trigger criteria have been set.

Make these settings on the [Trig & Alm] screen.

If trigger settings have been made on the [CH] screen, skip steps 1 and 2.

The settings in steps 1 and 2 are interlinked with those on the [CH] screen.

- 1 Set the [Trigger] to [On].
- 2 Select the [Timing] setting option to determine how triggering will affect recording.

Setting options: (* default setting)

Start* Start recording according to Start Trigger criteria.

Stop Stop recording according to Stop Trigger criteria.

Start&Stop Start and stop recording according to the Start and Stop Trigger criteria, respectively.

(Start and stop triggers can be set for each channel independently.)

- 3 Select how trigger sources are logically combined using the [Trig Source] - [Start] and [Stop] setting options.

Setting options:(* default setting)

OR* Triggering occurs when any one of the specified trigger source criteria is met. (includes external trigger signal)

AND Triggering occurs only when all of the specified trigger source criteria are met. (includes external trigger signal)

- 4 (When an external trigger is applied) Set the [Ext trig] - [Start] or [Stop] setting to

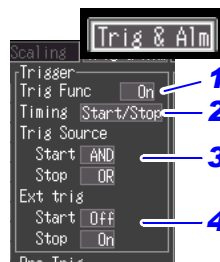

To apply a trigger when the upslope (↑) of the waveform crosses zero volts:

Trigger..... Level
Level..... 0 V
Slope..... ↑

When the trigger combining logic is set to [AND]

If trigger criteria are already met when you press the **START/STOP** key, no triggering occurs. Triggering occurs only after all trigger sources have ceased to meet the criteria at once, and are subsequently met again.

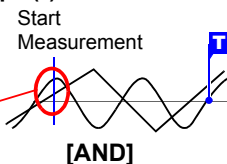

[AND]

One waveform has crossed above 0V as the other crosses on the upslope

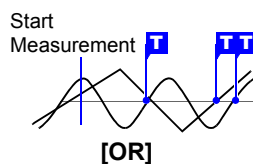

[OR]

Either waveform crosses 0V on the upslope

Setting Criteria for Pre-Trigger Recording (Pre-Trig)

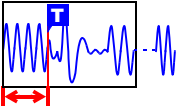

Select the [Start] or [Start&Stop] trigger timing setting to record waveforms both before and after trigger events.

However, pre-trigger recording is disabled when [Stop] trigger timing is selected.

Make the setting on the [Trig & Alm] screen.

For the [Pre-Trig] setting, specify the time (or number of days) to record before a trigger event.

To record waveforms after a trigger event, simply specify a recording time that is longer than the pre-trigger recording time.

Difference between [Waiting for pre-trigger] and [Waiting for trigger]

When measurement is started, the specified pre-trigger length is recorded. This period is indicated as the [Waiting for pre-trigger].

After the specified pre-trigger length has been recorded, the period indicated as [Waiting for trigger] continues until a trigger occurs.

During the [Waiting for pre-trigger] period, trigger events are not recognized even when the trigger criteria are met.

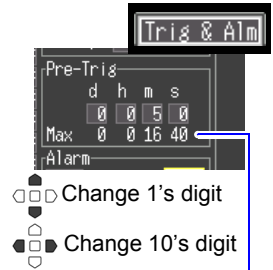

The maximum settable time span is displayed.

Pre-Trigger vs. Recording Time

Recording Time shorter than Pre-Trigger Time

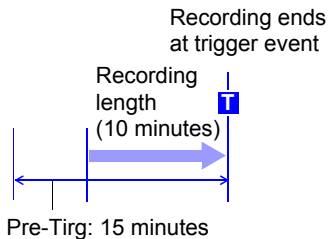

Recording Time longer than Pre-Trigger Time

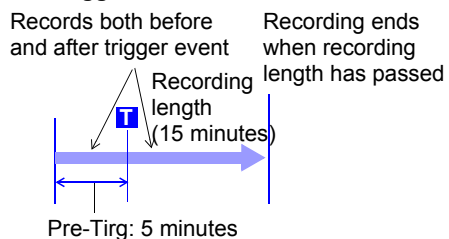

4.2 Alarm Output

You can enable beep tones and an alarm output signal (for external use) for each input channel by setting its alarm criteria. You can also view alarm output status on screens that display numerical values ([Wave+Value], [Value+Cmnt] and [Value]).

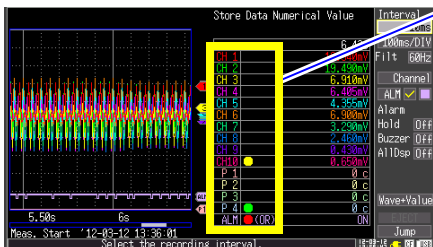

Alarm Criteria

Channel alarm status (CH1 to CH10 and P1 to P4)

- Yellow*: alarm criteria are satisfied
- Green: alarm criteria are not satisfied

*. When [Hold Alarm] is enabled (set to [On]), the indicator remains yellow because the criteria remain satisfied (until measurement is finished). The [Buzzer] alarm sound can be set to on or off. When [All display] is set to [On], the detected waveforms for CH1 to 10 and P1 to 4 set to the alarm source will also be displayed.

Alarm output status (ALM)

- Red: alarm signal output active
- Green: alarm signal output inactive

External alarm output requires connection to the external control terminals. See Chapter 9, "External Control" (p. 129) for details.

Select alarm input channels on the [CH] screen, and specify alarm criteria on the [Trig & Alm] screen.



Select the [CH] Screen.



Configuring Alarm Output

- 1 Select the [Channel] setting option to [ALM].
- 2 Set a check mark [] as shown to enable alarm output.
- 3 Set the [Hold Alarm] as required for your alarm output destination device.

Setting options:(* default setting)

Off* Disable the alarm output signal when alarm criteria are no longer met.

On Hold the alarm output active state until measurement is finished.

- 4 Enable or disable the alarm beeper by the [Buzzer] setting.

Setting options:(* default setting)

Off* The Memory HiLogger will not sound an audible beep during alarm signal output.

On The Memory HiLogger will sound an audible beep during alarm signal output.

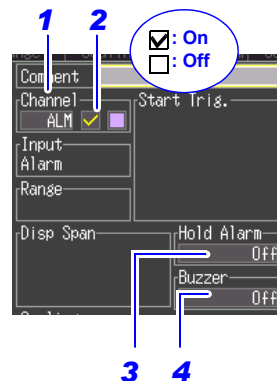

To stop the alarm beeper while measuring, set the beeper to [Off] in the ALM channel settings on the Waveform screen.

Setting Alarm Criteria for Each Channel

- 1 For the [Channel], select a channel for which you want to set alarm criteria.
- 2 Select [Alarm on.] to enable alarm criteria settings.
- 3 Select the alarm criteria type from the [Cond] setting options.

Setting options:(* default setting)

- Off*** Disable alarms for this channel.
- Level** Trigger an alarm when the input reaches a specified level.
- Window** Trigger an alarm when the input transitions through upper and lower limits (window).

Alarm criteria settings are not available unless a check mark [☑] is displayed next to the channel number.

- 4 Set the alarm criteria.
If you have selected [Level].

Setting options:

- ↑ Alarm output occurs when the input signal rises above the specified level threshold.
- ↓ Alarm output occurs when the input signal falls below the specified level threshold.

If you have selected [Window].

Setting options:

- In** Alarm output occurs when the input signal enters the range defined by the thresholds.
- Out** Alarm output occurs when the input signal exits the range defined by the thresholds.

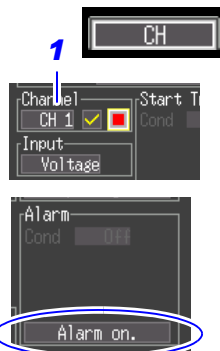

ALM appears when no channel output is checked (☑). In this case, select [Alarm on.] to enable alarm output settings, and then set alarm criteria.

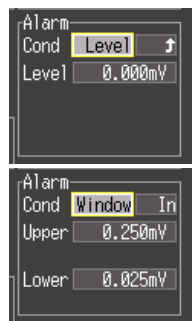

WAVE/DATA SET FILE Select the [Trig & Alm] Screen.



Selecting Combined Alarm Output Criteria

Select how you want to combine alarm output criteria from the [Alarm] setting options.

Setting options:(* default setting)

- OR*** Alarm output occurs when the alarm criteria specified for any alarm-enabled channel are satisfied.
- AND** Alarm output occurs only when the alarm criteria for every alarm-enabled channel are satisfied.

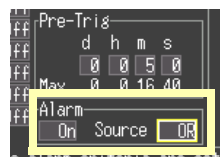



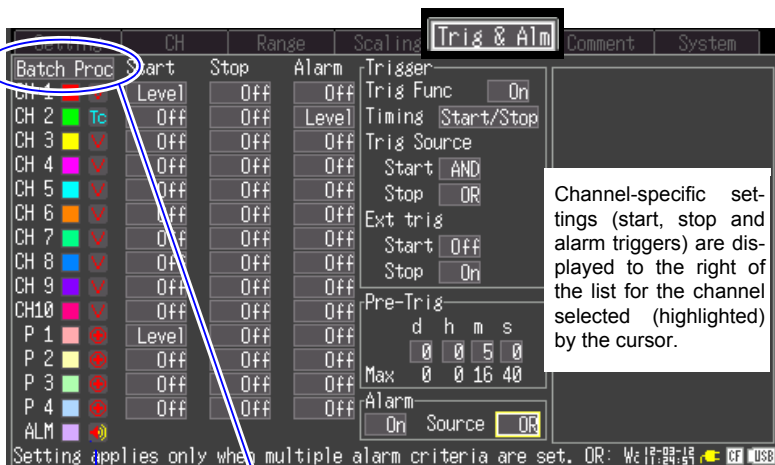

If set to [Off], change it to [On].

4.3 Confirming Trigger and Alarm Criteria Settings (List)

You can view and change trigger and alarm criteria settings for all channels. However, detailed criteria settings such as level, threshold and slope can only be changed on the [CH] screen (p. 68).



Input type

-  : Voltage
-  : Temperature
-  : Integration
-  : Revolution
-  : Alarm

Select **[Batch Proc]** to initialize settings and to copy trigger and alarm settings from CH1 or P1 to the other channels. Copyable settings include level, window thresholds and slope.

See: "Batch Copying Channel Settings" (p. 63)

4.4 Starting and Stopping Recording by Timer

Make these settings to record at a specific time. Recording can be set to repeat at specific intervals between the set start and stop times. Before setting, confirm that the Memory HiLogger clock is set to the correct time. If not, reset the clock on the [System] screen (p. 124).

1 WAVE/DATA SET FILE → Select the [Setting] Screen.

2 Move to a setting item.

3 Open the setting options for the item to be set.

4 Select from the listed options.

5 Apply

Change 1's digit Change 10's digit

- 1** Set the [Timer] setting to [On].
- 2** Enable (set to [On]) the desired timer setting items.

Setting options:

Start Set the recording start time.

Stop Set the recording stop time.

Interval Set the recording repetition interval.
This setting is enabled on when [Repeat] is set to [On].

- 3** Set the year, month, day, hour, minute and second for the start or stop time.

To enter the current time as the start or stop time, select the clock mark (⌚) and press the **ENTER** key.

- 4** For the [Interval] settings, set the amount of time (days, hours, minutes and seconds) between recording repetitions.

- 5** Press **START**.

[Wait Timer] will be displayed at the bottom of the waveform screen.

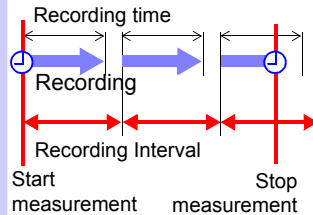

When recording times are specified, recording operation depends on the repetition and recording time settings (p. 78).

4.4 Starting and Stopping Recording by Timer

Example: To record daily from 9:00 to 17:00 for one month beginning 1/1/2012,
Repeat Recording: On, Timer: On

		(YY-M-D)	(H:M:S)	12-1-1	12-1-1	12-1-2
(From)	Start	On	12-1-1	9: 0: 0	9:00	17:00
(Until)	Stop	On	12-1-31	17: 0: 0		
(Time from one recording to the next)	Interval	On	1	0: 0: 0		
(recording length)	Cont:	Off		8: 0: 0	9:00 to 17:00 is 8 hours	

Note: When all channels are measured and the recording interval is slower than 200ms.

4.5 About Recording Operation

Recording operation depends on the combination of trigger, timer and repeat recording (On/Off) settings.

○ Press **START/STOP**
 ⌚ Timer start/stop time
 T Trigger criteria match

Cont.	Trigger	Timer	Repeat: Off	Repeat: On
Off	Off	Off	<p>Start recording Stop recording</p>	<p>Start recording Stop recording</p>
Off	Off	Off	<p>Start recording Stop recording</p>	<p>Start recording Stop recording</p>
Recording is stopped before one recording length has elapsed			<p>Start recording Stop recording</p>	<p>Start recording Stop recording</p>
Off	Off	Start	<p>Start recording Stop recording</p>	<p>Start recording Stop recording</p>
Off	Off	Stop	<p>Start recording Stop recording</p>	<p>Start recording Stop recording</p>
Off	Off	Stop	<p>Start recording Stop recording</p>	<p>Start recording Stop recording</p>
Off	Off	Start/Stop	<p>Start recording Stop recording</p>	<p>(Repeat Recording: same as Off)</p>

4.5 About Recording Operation

○ Press **START/STOP** ⌚ Timer start/stop time **T** Trigger criteria match

Cont.	Trig-ger	Timer	Repeat: Off	Repeat: On
Off	Start	Off	<p>Start recording Stop recording</p>	<p>Start recording Stop recording</p>
Off	Stop	Off	<p>Start recording Stop recording</p>	<p>Start recording Dead time Stop recording</p>
Off	Start/Stop	Start/Stop	<p>Start recording Stop recording</p>	<p>Start recording Dead time Stop recording</p>
On	Off	Off	<p>Start recording Stop recording</p>	(Repeat Recording: same as Off)
On	Stop	Off	<p>Start recording Stop recording</p>	<p>Start recording Dead time Stop recording</p>

Waveform Analysis

Chapter 5

About the Waveform and Numerical Value Screens

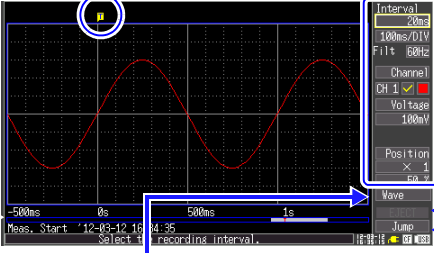

Trigger Mark
Indicates a trigger event

Analog and pulse waveforms
Displays acquired data as waveforms.

Time Values

Measurement Configuration
You can change these settings (p. 41) You can switch between channel settings and event search settings. "Event Search" (p. 88)

Eject
Allows you to change the CF card or USB flash drive while saving data in real time. (p. 48)

Jump Function (p. 83)

Scroll Bar
Shows the range and position of the displayed waveform. Viewing the Scroll bar (p. 82) Information such as measurement start time and trigger times is displayed below the scroll bar.

You can select from seven screen configurations (p. 18)

- Gauges can be displayed for each channel (p. 84)
- Numerical values at waveform cursor positions can be viewed (p. 84)
- Numerical calculation results can be displayed (p. 113)
- Measurement data can be displayed as waveforms and numerical values, as numerical values with comments, or as numerical values only (p. 87).

5

Chapter 5 Waveform Analysis

Settings can be changed on the Waveform/Numerical screen.

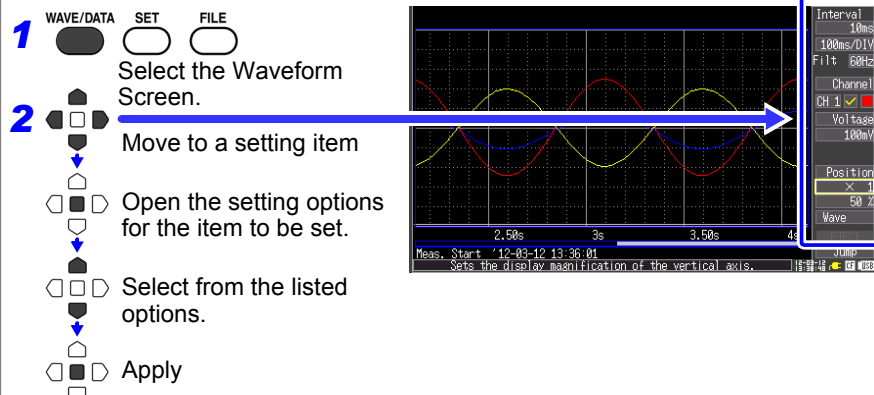

- 1** WAVE/DATA SET FILE
Select the Waveform Screen.
- 2** Move to a setting item
- Open the setting options for the item to be set.
- Select from the listed options.
- Apply

Interval: 20ms
100ms/DIV
Filt: 60Hz
Channel: CH 1
Voltage: 100mV
Position: x 1

Wave

Meas. Start '12-03-12 13:36:01
Sets the display magnification of the vertical axis.

5.1 Viewing Waveforms

Scrolling Waveforms

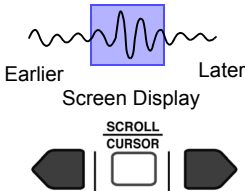

When measuring or displaying an existing waveform, use the **SCROLL/CURSOR** keys to scroll.

You can scroll to any part of a waveform while measuring. To return to the current waveform position, move the selection cursor to [Trace] at the lower right of the screen, and press the ENTER key.

To jump to the start or end of a waveform, hold the **ESC** key while scrolling.

If internal memory becomes full when measuring with [Cont] set to [On], recording continues by overwriting the oldest acquired data. Therefore, even when scrolling earlier parts of waveforms, the overwritten data is lost.

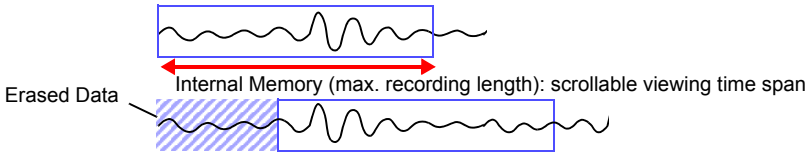

Verifying Waveform Display Position

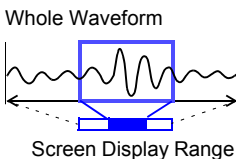

From the scroll bar you can verify the relative position and size of the displayed portion of a waveform within the overall recorded waveform.

The width of the currently displayed time span indicator within the scroll bar depends on the time base (time per horizontal division) setting, even when the recording length is unchanged.

Magnifying and Compressing Horizontally

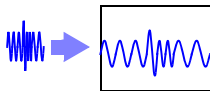

Waveforms can be magnified (expanded or compressed) along the time axis by changing the time per horizontal division.

Detailed waveform data is usually best observed with the time axis expanded, while longer-term trends are best observed with it compressed.

Horizontal magnification can be changed while measuring. However, when measuring with auto saving enabled, the 100, 200 and 500 ms settings are not selectable.

Select from the **[Time/DIV]** setting options.

Setting options:

100ms*, 200ms, 500ms, 1s, 2s, 5s, 10s, 20s, 30s, 1min, 2min, 5min, 10min, 20min, 30min, 1h, 2h, 5h, 10h, 12h, 1day [div] (* default setting)

Indicates the center point for horizontal magnification. When the A/B cursors are displayed, the position of cursor A becomes the reference point.

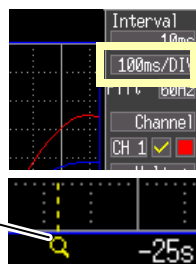

Viewing Any Waveform Location (Jump Function)

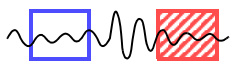

When the recording length of a waveform is long, you can specify the portion to be displayed immediately.



1 Select the Waveform Screen

2 Select **[Jump]**.

Apply

The location of the currently displayed portion of the overall waveform is indicated by the ▼ mark on the scroll bar.

3 Move the ▼ mark to display a different portion of the waveform.

4 Apply

The portion of the waveform at the ▼ mark is displayed.

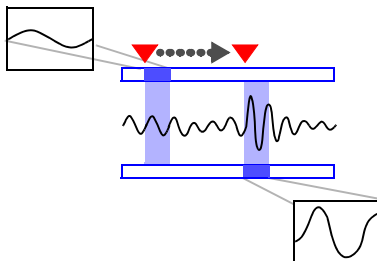
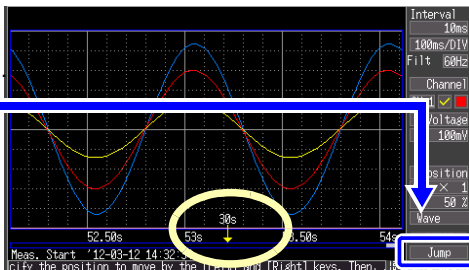

5.2 Selecting Display Options

Displaying Gauges

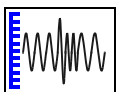

A gauge corresponding to the measurement range of each channel can be displayed at the left side of the screen, for confirming measurement values. The color of the gauge matches the waveform display color of its input channel.

Press the **CH ▲** or **▼** key to display the gauges for other channels. However, note that when measurement data is displayed, only those channels that are enabled (set to On) for measurement can be selected.



Select the Waveform Screen.



Select [Gauge+Wave].



Apply

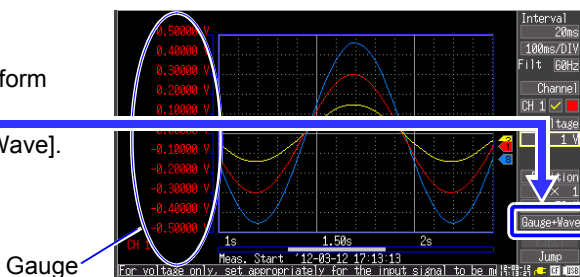

Displaying Cursor Values

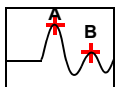

Time difference and potential difference (and when scaling is enabled, scaling values) can be read as numerical values using the A/B cursors.

About Cursor Values

Cursor Type	Example	Cursor Value
Trace Cursors		Displays the time and measurement values at the A/B cursors, or the time and measurement differences between the A/B cursors. Displays the intersections (trace points) of cursors and waveforms. (the intersections of waveform traces of selected channels)
Vertical Cursors		Displays the time and frequency values at the A/B cursors, or the time and frequency differences between the A/B cursors.
Horizontal Cursors		Displays the measurement values at the A and B cursors for the selected channel(s), or the difference between A/B cursor values. A/B cursors can be enabled for any channel.

Cursor values can be displayed for all channels, or for only desired channels.

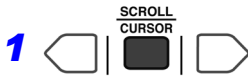

Displays the A/B cursors and the values at the cursor positions. To hide the cursor items again, press the **SCROLL/CURSOR** key.

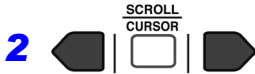

Move the cursors to display numerical values along the waveform.

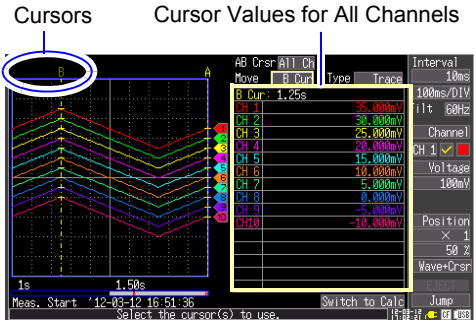

Selecting which channels have their cursor values displayed

Select from the **[AB Crsr]** setting options.

- **[All Ch]***
Displays all channels. The cursor selected for [Move] is displayed (select [AB Cur] to display B – A difference values).
- **[Ch Set]**
Specify which channels to display with A and B cursors. The cursor values for the specified channels are displayed.
(* default setting)

Moving the Cursors

Select from the **[Move]** setting options.

A Cur*

B Cur

AB Cur

(* default setting)

Cursor Value for Specified Channels

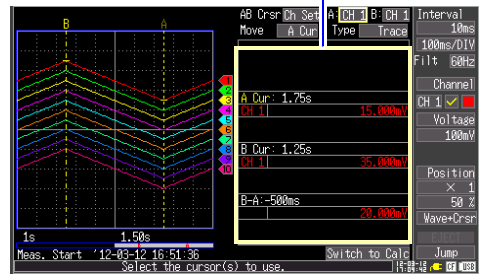

AB Crsr Ch Set A: CH 1 B: CH 1
Move A Cur Type Trace

Changing Cursor Type

Select from the **[Type]** setting options.

Trace*

Vert (Vertical)

Horz (Horizontal)

(* default setting)

To move cursors more quickly, hold the **ESC** key.

5.2 Selecting Display Options

Specifying a Waveform Time Span

Specify a waveform time span when saving a partial waveform or applying numerical calculations (Trace cursors or Vertical cursors).

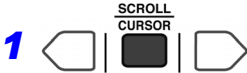

The A/B cursors and cursor values are displayed.

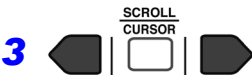
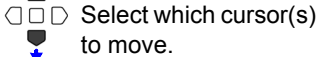
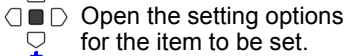

Move the A/B cursors to specify the time span.

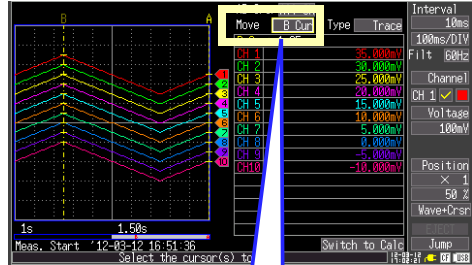

[Move]
A Cur
B Cur
AB Cur

5.3 Inserting Event Marks (Search Function)

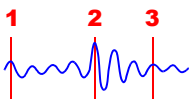

You can insert up to 100 event marks at any point while measuring, to help find them later.

See "Searching Event Marks" (p. 90)

Event marks can be inserted while viewing waveforms or by applying external signals.

Inserting Event Marks While Viewing Waveforms

Use this procedure to insert event marks while viewing data on the Waveform/Numerical Value screen during measurement. Event marks are numbered in the sequence they are inserted.



Select the Waveform Screen.

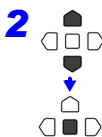

Select **[Channel]**.

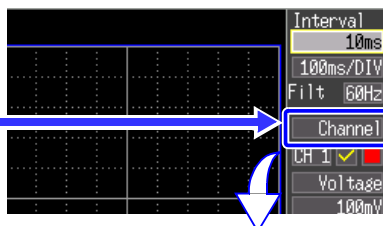

Event mark settings are displayed.

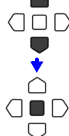

Select **[Event]**.



Apply

3 Move to **[Make Mark]**.

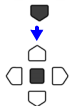

Press to insert an event mark. Event numbers appear on the waveform displayed when you select **[Make Mark]**.

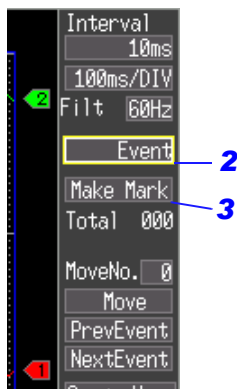

Inserting Event Marks Using External Input Signals

Event marks can be inserted by applying external input signals.

See: Input signal specifications in section 9.2, "External Trigger Input" (p. 131)

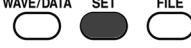
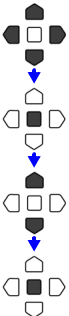
- 1  Select the [System] screen.
- 2  Select [External Trig In].
Open the setting options for the item to be set.
Select [Event].
Apply

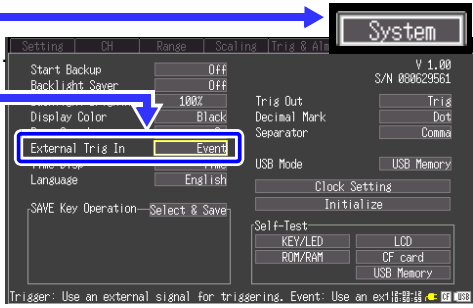

Settings | CH | Range | Scaling | Trig & All

System

V 1.00
S/N 000629561

Start Backup Off
BackLight Saver Off

100%

Display Color Black
Trig Out Trig
Decimal Mark Dot
Separator Comma

External Trig In **Event**

Language English
USB Mode USB Memory

Clock Setting
Initialize

SAVE Key Operation—Select & Save

Self-Test
KEY/LED LCD
ROM/RAM CF card
USB Memory

Trig In: Use an external signal for triggering. Event: Use an ext. trigger signal.

- 3 Connect the external signal input (p. 129).
Event marks are inserted when the external trigger signal (EXT.TRIG input terminal 2) transitions on the falling edge from High level (3.0 to 5.0 V) to Low level (0 to 0.8 V).

5.3 Inserting Event Marks (Search Function)

Searching Event Marks

Any event mark can be found by searching.

1    Select the Waveform Screen.

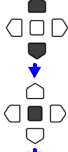
2  When [Channel] is displayed, switch to **[Event]**.

 The event setting items are displayed.

 Apply

3  For the **[MoveNo.]** setting, select the number of the event you want to find.

4  Select **[Move]**.

 The waveform with the specified event number is displayed.

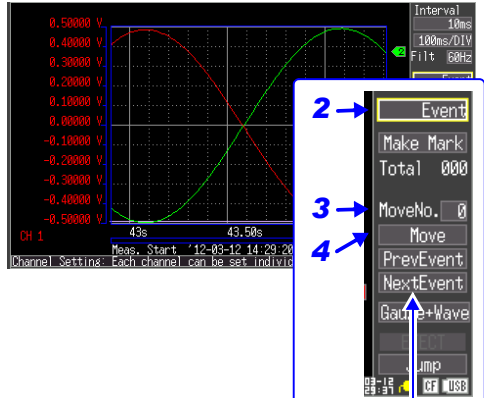

You can search by incrementing and decrementing the event number.

[PrevEvent]: Search for the previous event mark.

[NextEvent]: Search for the next event mark.

Saving & Loading Data

Chapter 6

Measurement data acquired by the Memory HiLogger can be saved to a CF card or USB flash drive. (p.93)

The CF card is treated as Drive A:, while the USB flash drive is treated as Drive B:. There are three save methods: [Auto Save], which saves data automatically at the time of measurement; [Select & Save], which allows data to be saved after measurement; and [Quick Save].

Refer to 6.3, "Saving Data" (p. 96) for details.

6.1 About Saving and Loading Data

When saving data, a folder named HIOKI_LR8431 is created, and files are stored in the folder as follows.

O = Available, X = Not available

File Type	File Format	Folder Name	File Name *3 (Auto-numbered from 1)	Save		Load	
				Auto	Man-ual	Model LR8431 -20	PC
Settings Data	Binary	CONFIG	CONF0001.SET	×	○	○	×
Waveform Data*1	Binary	DATA\{(Date)*4 (e.g. 12-07-30)	WAVE0001.MEM	○	○	○	○
	Text *5		WAVE0001.CSV	○	○	×	○
Numerical Calculation Results	Text *5	MEASUREMENT	MEAS0001.CSV	○	○	×	○
Captured Screen Image	BMP *2	PICTURE	SCR00001.BMP	×	○	○	○

*1. Save waveform data in binary format if you intend to view it later in the HiLogger or on a computer with the supplied Logger Utility program. Waveform data and some measurement-related settings data are saved.

To save a waveform partially, specify a period by using A/B cursors before saving (p.86).

*2. BMP Format: This is a standard Windows® graphics format. These files can be handled by many graphics programs.

*3. Appendix 2, "File Naming" (p. A7)

*4. Date (YY-MM-DD) folders are automatically created inside the DATA folder.

*5. When opening a CSV file in a spreadsheet program, note that the number of rows that can be loaded at one time is limited (p. A7).

When an option other than [Separator: Comma] has been selected on the [System] screen, the file extension will be .TXT rather than .CSV.

6.1 About Saving and Loading Data

Depending on file size and CF card or USB flash drive capacity, each folder can store over 1,000 files. However, the file screen display is limited to a maximum of 1,000 files. Also, as more files are created, more time is needed to start and stop recording. We recommend setting measurement criteria so that the number of saved files stays below 1,000 whenever possible.

Directory Structure for Saved Data

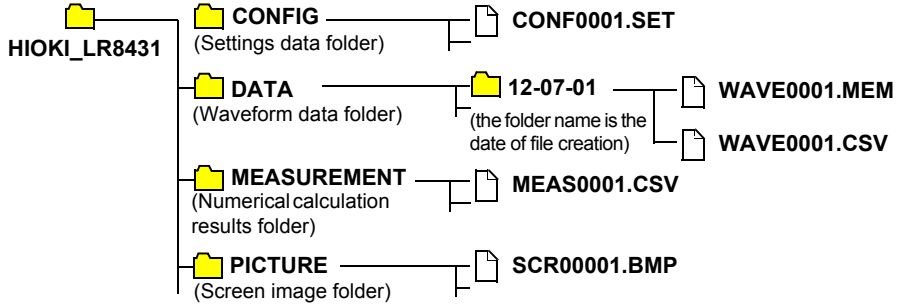

6.2 Using a CF Card/USB flash drive

To save and reload HiLogger measurement data, use an optional CF card or an after-market USB flash drive.

Hioki options PC cards
(includes adapter)

- Model 9727 PC Card 256M
- Model 9728 PC Card 512M
- Model 9729 PC Card 1G
- Model 9830 PC Card 2G

*The Model 9726 PC Card 128M can also be used.

Important

Use only CF cards sold by Hioki. Compatibility and performance are not guaranteed for CF cards made by other manufacturers. You may be unable to read from or save data to such cards.

This Memory HiLogger does not require a CF (CompactFlash) adapter. See 6.5, "Data Management" (p. 105) for details about managing data storage in the card.

CAUTION

- During battery-only operation, data may fail to be stored properly if battery charge is exhausted while saving. In the worst case, the CF card could be damaged, so pay appropriate attention to the discharge state of the battery pack.
- If the Eject button is in the released position, press it in first before inserting the CF card all the way in. Inserting the CF card when the Eject button is released may damage the instrument. If the CF card does not go all the way in, do not force it in. Press the Eject button once to release it, then press it again and insert the CF card all the way in.

NOTE

- Although data can be saved in real time to a USB flash drive, it is recommended to use a CF card for this purpose due to the superior data protection offered by that media. Proper operation of media other than Hioki optional CF cards is not guaranteed.
- USB flash drives with security functionality such as password or fingerprint authentication cannot be used.

CF Card Insertion & Removal

Cover

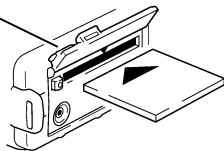

Eject Button

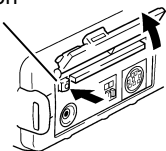

Inserting a CF card

- 1** Open the CF card slot cover.
- 2** Press the Eject button in if it is in the released position.
- 3** Face the CF card with the arrow mark (▲) on top, and insert it in the direction of the arrow all the way in the slot.

Removing a CF card

- 1** Open the CF card slot cover.
- 2** Press the Eject button (to release it).
- 3** Press the Eject button again and pull the card out.

USB flash drive Insertion & Removal

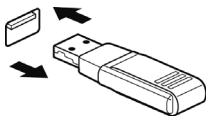

Inserting a USB flash drive

Align the USB flash drive connector with the USB port, and insert it all the way in.

Removing a USB flash drive

Pull the USB flash drive out.

See: "Replacing Removable Storage During Real-Time Saving" (p. 48)

NOTE

- When using a USB flash drive, set the USB mode on the [System] screen to [USB Memory]. USB flash drives cannot be used while the USB mode setting is [USB Communication] or [USB Drive].
- The [USB Memory], [USB Communication], and [USB Drive] USB mode settings are exclusive and cannot be used simultaneously.

Formatting a CF Card/USB flash drive

The CF card or USB flash drive can be formatted by a PC or by the HiLogger. Format a new CF card or USB flash drive before use.

This procedure describes how to format a CF card or USB flash drive in the HiLogger.



Select the File Screen.

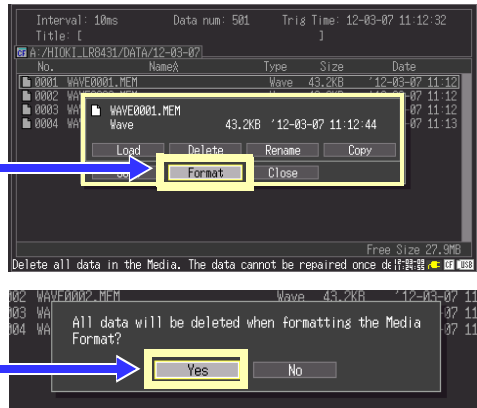
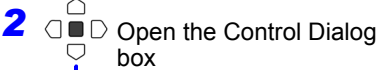

The Format Confirmation dialog appears.

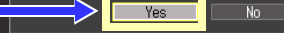

The Format Confirmation dialog appears again.

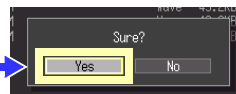
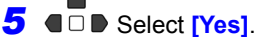

NOTE Formatting irretrievably erases all data on the CF card/USB flash drive. Always backup important data from the CF card/USB flash drive before formatting.

6.3 Saving Data

Basically, three methods are available for saving.

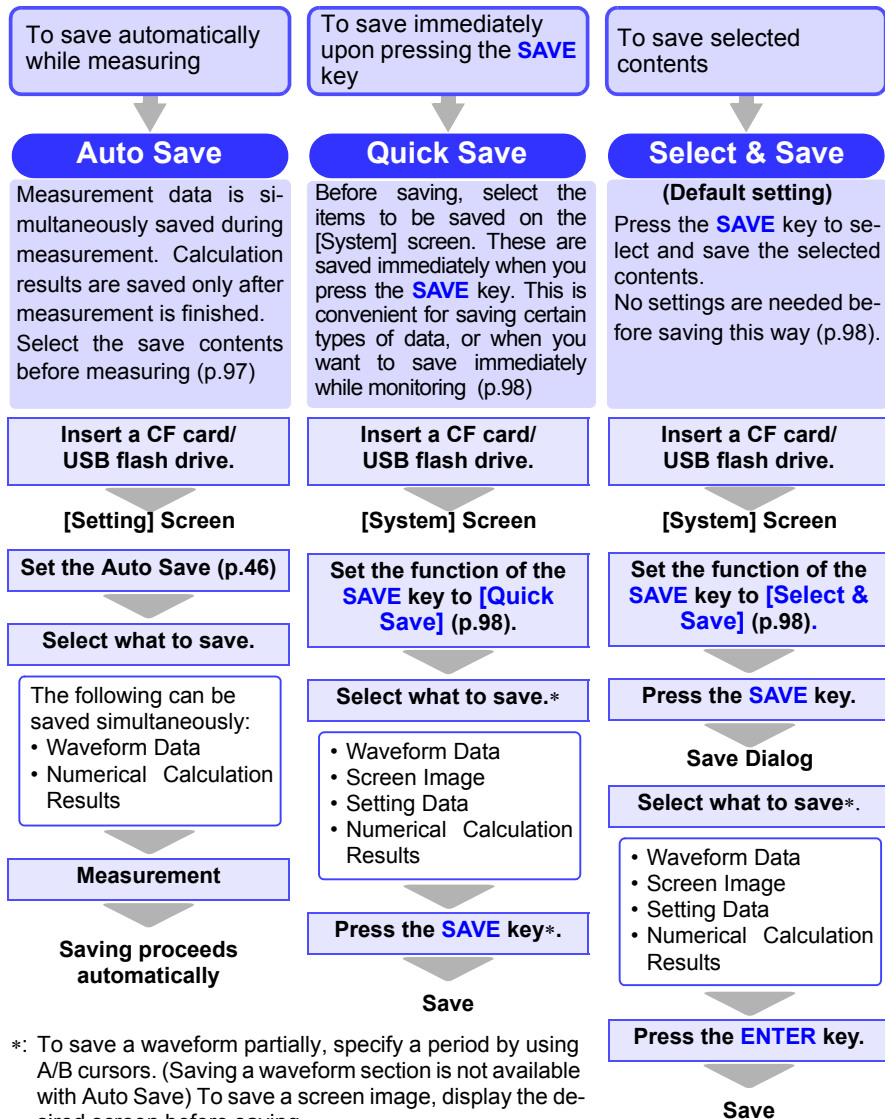

The LR8431-20 and 8430-20 use compatible waveform data, display image, and settings data formats that can be read by both instruments.

Automatic Saving

Before measuring, configure saving on the [Setting] screen. Waveforms and numerical calculation results can be saved automatically. Folders are created for saved data according to data type, and files are automatically numbered (p.91). For waveform data, folders named with the current date (YY-MM-DD) are created automatically. Before starting to measure, confirm that Auto Save is configured correctly, and that the CF card or USB flash drive is properly installed.

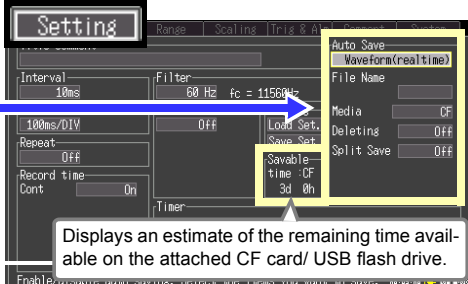
1  → 

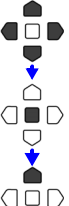
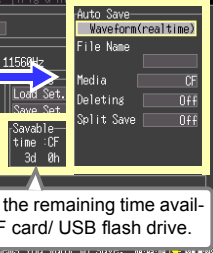
2  → 

Select the [Setting] Screen.

Select the desired save method from the [Auto Save] setting options.

Displays an estimate of the remaining time available on the attached CF card/ USB flash drive.

Save methods:

Off

Automatic saving is disabled.

Waveform (realtime) *1

Waveform data in binary format is saved to CF card while recording.

CSV(realtime) *1,*2

Waveform data in text format is saved to CF card while recording. Saved data cannot be reloaded in the HiLogger.

Calc(post meas.)

Calculation results are saved to CF card after recording. When [Repeat] is enabled ([On]), calculation results for each recording are included in the recorded data file.

Waveform + Calc *1

Waveform data in binary format is saved while recording, and calculation results are saved when recording stops.

CSV + Calc *1,*2

Waveform data in text format is saved while recording, and calculation results are saved when recording stops.

*1. Otherwise, make advanced settings as needed (p.46).

See: "When [Waveform(realtime)], [CSV(realtime)], [Waveform + Calc], [CSV + Calc] is selected" (p. 47)

*2. The [CSV (real time)] and [CSV + Calc] settings are not available when the record interval is 10ms or 20ms. Also, when opening a CSV file in a spreadsheet program, note that the number of rows that can be loaded at one time is limited (p. A7). When an option other than [Separator: Comma] has been selected on the [System] screen, the file extension will be .TXT rather than .CSV.

To save calculation results automatically, configure calculation settings before starting measurement (p.113).

When saving waveforms automatically, horizontal axis display setting is restricted when starting measurement, but can be freely adjusted for analysis afterwards (although 100, 200 and 500 ms horizontal axis settings are automatically changed to 1 s when measurement starts, and cannot be reselected while measuring).

 Apply

3 After making any other necessary settings, press the **START/STOP** key.

Data is automatically saved to the CF card or USB flash drive when measurement finishes. ("Directory Structure for Saved Data" (p. 92))

Selecting the Manual Saving Method [Quick Save]/[Select & Save]

Two manual saving methods are available: [Quick Save] and [Select & Save], both of which offer the same setting options.

When saving measurement data, folders are created on the CF card or USB flash drive for each data type, and files are automatically numbered (p.91)

1 WAVE/DATA SET FILE → **System**

Select the [System] Screen.

2 [Up/Down] → Move to a setting item.

[Left/Right] → Open the setting options for the item to be set.

[Left/Right] → Select from the listed options.

[Enter] → Apply

Selecting [SAVE Key Operation] setting options.

Setting options: (* default setting)

Select & Save* Pressing **SAVE** displays a dialog. Select the type of contents to be saved, and save the data.

Quick Save Pressing **SAVE** saves data according to the settings on the [System] screen.

[Select & Save]

SAVE

The Save dialog appears. Select from the saving options in this dialog.

- Save Waveforms (p.99)
- Save Screen Image (p.100)
- Save Numerical Calculation Results (p.101)
- Save Settings (p.102)

[Quick Save]

Setting items are displayed. Select your saving options.

The top screenshot shows a waveform display with a dialog box titled 'Select the file type to save'. The dialog has three options: 'Media' (set to 'CF'), 'Waveform', and 'Screen Image'. The bottom screenshot shows the 'System' settings screen with a yellow box highlighting the 'SAVE Key Operation—Quick Save' option.

*Select & Save displays the selection dialog when the [SAVE] key is pressed.

Saving Waveform Data (with the SAVE Key)

Waveform data is saved in files named **WAVEnnnn.MEM** in folders named with the date of recording (YY-MM-DD), created in the **[HIOKI_LR8431]-[DATA]** folder (p.91).

To save a partial waveform, specify the time span to save beforehand (p.86).

Select & Save

SAVE

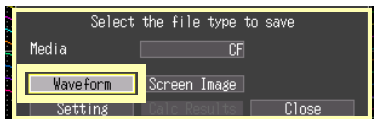

(Select from the dialog that appears when you press the **SAVE** key)

Set the **[Save media]**.

(CF card/USB flash drive)

Select **[Waveform]**, and press the **ENTER** key.

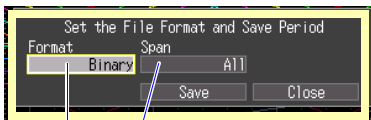

1 2

1 For the **[Format]** setting, select the data saving format. (* default setting)

Binary Select this format to be able to reload the saved data into the instrument, or so that it can be loaded into the Logger Utility program.

Text Select this format to save the data as a text file.

2 From the **[Span]** setting options, select the portion of the data to save.

All *, A-B, Start-A, Start-B, A-End, B-End

(All = all acquired waveforms, A = Cursor A, B = Cursor B,

Start = start of acquired waveforms, End = end of acquired waveforms)

Select **[Save]** and press the **ENTER** key.

Select **[Yes]** in the confirmation dialog, and press the **ENTER** key.

Quick Save

WAVE/DATA SET FILE

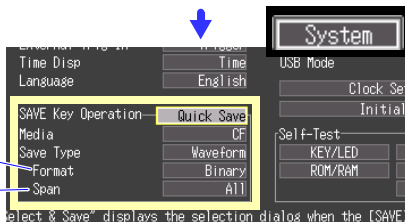

(Before pressing the **SAVE** key, make settings on the System screen)

Set the **[Priority media]**.

(CF card/USB flash drive)

Select **[Waveform]** as the **[Save Type]**.



SAVE



Capturing a Screen Image (With the SAVE Key)

Captured screen image files are automatically named **SCRnnnnn.BMP** in a folder named **[HIOKI_LR8431]-[PICTURE]** (p.91).

Select & Save

SAVE  Display the screen to capture, and press the **SAVE** key.

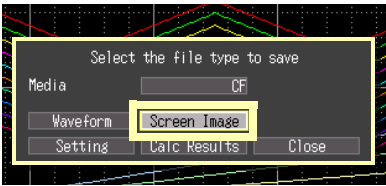



(Select from the dialog that appears when you press the **SAVE** key)

Set the **[Save media]**.
(CF card/USB flash drive)

Select **[Screen Image]**, and
press the **ENTER** key.

Select **[Yes]** in the confirmation dialog, and press the **ENTER** key.

Quick Save

WAVE/DATA  **SET**  **FILE** 

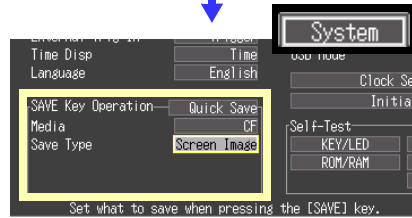

(Before pressing the **SAVE** key, make settings on the System screen)

Set the **[Priority media]**.
(CF card/USB flash drive)

Select **[Screen Image]**
as the **[Save Type]**.

Display the screen to capture

SAVE 

Saving Numerical Calculation Results (With the SAVE Key)

Numerical calculation settings are necessary before saving results (p.113). Numerical calculation result files are automatically named MEAS $nnnn$.CSV in a folder named [HIOKI_LR8431]-[MEASUREMENT] (p.91).

Select & Save

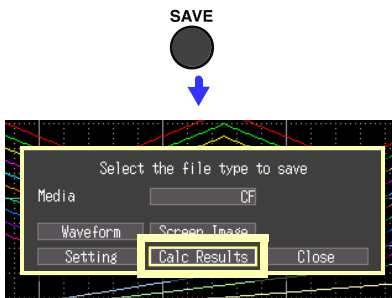

(Select from the dialog that appears when you press the **SAVE** key)

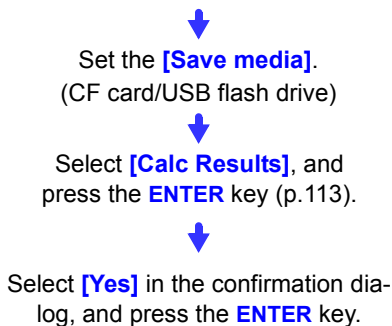

Quick Save

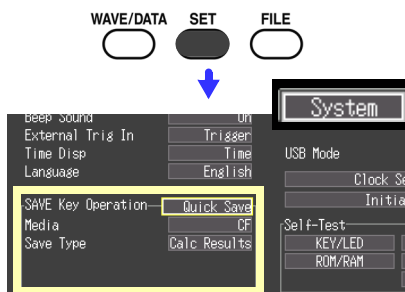

(Before pressing the **SAVE** key, make settings on the System screen)

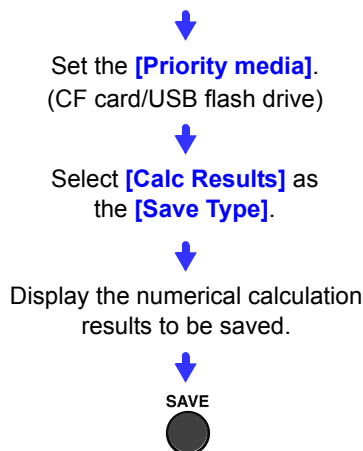

By specifying a particular time span for numerical calculation, only the results for that time span are saved.

Saving Setting Configurations

Setting configurations can be saved as data files and later reloaded into the Memory HiLogger when you need to make more measurements with the same settings.

Up to ten setting configurations can be saved to internal memory, and more can be stored on a CF card or USB flash drive.

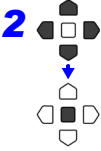
- 1  → Select the **[Setting]** Screen.
- 2  Select **[Save Set.]**.
Apply
The Save dialog appears.

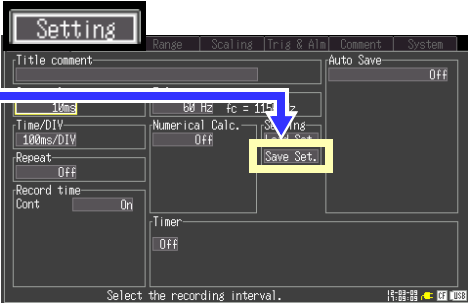

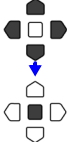
- 3  Select whether to save to the LR8431-20's memory or to a CF card or USB flash drive.
Apply

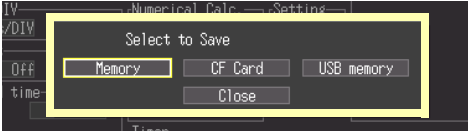

- 4 (When **[Memory]** is selected)
 Select **[Save]** for the configuration instance (No.) to save.
Enter a comment as needed.
Apply



Comments entered on the [Comment] screen are displayed here.

(When [CF Card/USB flash drive] is selected)

Setting configuration files are automatically named CONFnnnn.SET in a folder named [HIOKI_LR8431]-[CONFIG] (p.91)
To reload a setting configuration (p.103)

6.4 Loading Data on the Memory HiLogger

Previously stored binary waveform data, captured screen images and saved setting configurations can be reloaded into the Memory HiLogger (p.91)

Loading a Setting Configuration

Setting configurations saved in the Memory HiLogger's memory or on a CF card or USB flash drive can be reloaded.

See: "Saving Setting Configurations" (p. 102)

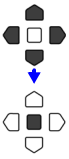
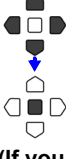
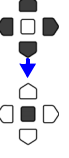
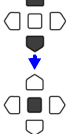
- 1  Select the **[Setting]** Screen.
- 2  Select **[Load Set.]**.
Apply
The loading dialog appears.
- 3  Select whether to load a setting configuration from LR8431-20's memory or CF card or USB flash drive.
Apply
- 4 (If you selected **[Memory]**)
 Select **[Load]** for the configuration you want to load.
Apply
(If you selected **[CF Card/USB flash drive]**)
 Select the configuration file to load. (CONFnnnn.SET)
Apply

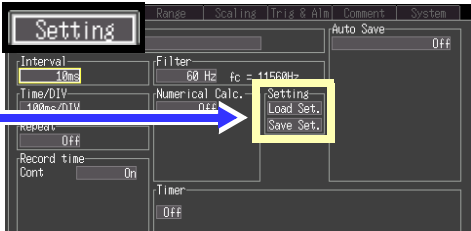
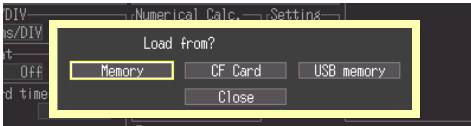
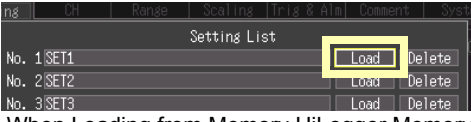
When Loading from Memory HiLogger Memory
The list of configurations stored in Memory HiLogger memory is displayed.

No.	NameA	Type	Size	Date
0001	CONF0001.SET	Set	10.0KB	'12-03-07 15:52
0002	CONF0002.SET	Set	10.0KB	'12-03-07 15:52
0003	CONF0003.SET	Set	10.0KB	'12-03-07 15:52

When Loading from CF card or USB flash drive
Configuration files stored in the [HIOKI_LR8431]-[CONFIG] folder on the CF card or USB flash drive are displayed.

Memory HiLogger settings are reconfigured to those in the loaded configuration file.

To automatically load settings data (auto-setup)

Settings data saved under the filename "STARTUP.SET" in the "HIOKI_LR8431"- "CONFIG" folder will be loaded automatically when the instrument is turned on. If settings have been saved on both the CF card and USB flash drive, the CF card's settings will take precedence. ("STARTUP.SET" may not be loaded from USB flash drives that take a long time to be recognized.)

6.4 Loading Data on the Memory HiLogger

Loading Waveform Data and Screen Images

Binary waveform data or captured screen images can be reloaded into the Memory HiLogger.



Select the File Screen.



The contents of the CF card are displayed.

Select a file to load

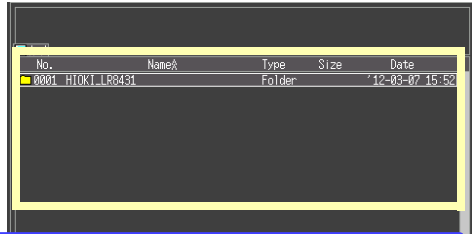

Displays the child folder.
After selecting a folder by pressing the ENTER key, select **[Change]** in the displayed control dialog box.

Displays the parent folder.

HIOKI_LR8431	Folder	'12-03-07 15:52
--------------	--------	-----------------

Buttons: Change, Delete, Rename, Sort, Format, Close



Apply

The control dialog box appears.



Select **[Load]**.

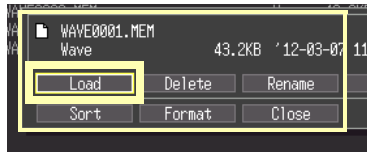

Apply

(When loading waveforms)

When the amount of data in a file to be loaded exceeds the internal memory capacity, you can specify a data point (number) at which to start loading. The loadable data size shows the maximum number of data points that can be loaded. This setting is not needed if the data to be loaded will fit in internal memory. Select **[OK]** to load the data.

File name	WAVE0001.MEM	Waveform data file name
Trigger Time	'12-03-07 11:12:32	Waveform data trigger time
Data num	501	Number of data points in the file
Saved Ch	CH1 CH2 CH3 CH4 CH5 CH6 CH7 CH8 CH9 CH10 P 1 P 2 P 3 P 4 ALM	Channels saved in waveform data to be loaded (Analog, Pulse, and Alarm)
Readable data nu	203889	Maximum number of data points that can be loaded (to internal memory)
Top of data num	0 ~ 99999	Settable range of offset to first data point
Scope of data re	'12-03-07 11:12:32 ~ '12-03-07 11:12:37	Times of first and last data points to be loaded

Buttons: OK, Cancel

6.5 Data Management

You can manage data stored on a CF card or USB flash drive in the Memory HiLogger.

- Load a file (when the file is selected) (p.103)
- Move displayed folders (when the folder is selected) (p.106)
- Delete data (p.106)
- Rename files and folders (p.107)
- Sort files (p.109)
- Format a CF card (p.95)
- Copy data (p.108)

The following operations can be performed from the control dialog box displayed by pressing the ENTER key from the File screen.

1 WAVE/DATA SET FILE
Select the File Screen.

2 Opens the control dialog box.

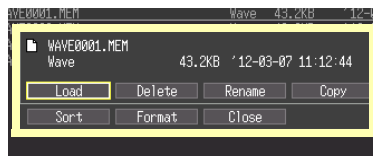

Switching removable storage

1 WAVE/DATA SET FILE
Select the File screen
CF card contents* are displayed.

2 WAVE/DATA SET FILE
Press FILE again.
USB flash drive contents are displayed.
Press FILE to toggle between drive A (CF card) and B (USB flash drive).

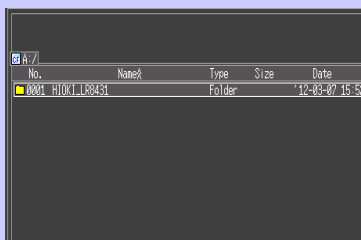

*: When only a USB flash drive is inserted in the HiLogger, its contents are displayed.

The drive cannot be switched.

Viewing Folder Contents and the Parent Folder



Select the File Screen.

The contents of the card are displayed.

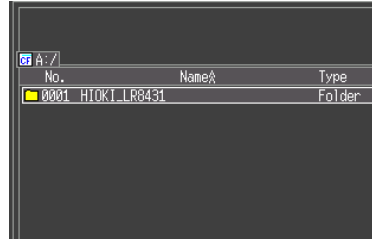

Select a folder to view.



View child folder (view contents of the currently highlighted folder) (press the ENTER key and select **[Folder]** in the displayed control dialog box)

Displays the parent folder.

Deleting Data

Folder and files on the CF card or USB flash drive can be deleted.



Select the File Screen.

The contents of the CF card are displayed.



Select a file to delete.



Apply



Select **[Delete]**.

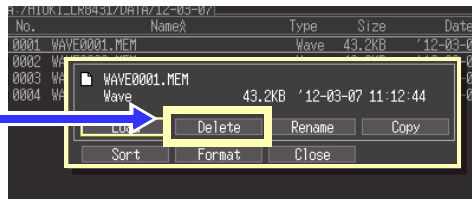

Apply

A confirmation dialog appears. Select **[Yes]** and press the ENTER key to delete.

NOTE

- The “HIOKI_LR8431” and “DATA” folders are locked to prevent the inadvertent deletion of data. If you wish to delete these folders, change their names.
- Files whose read-only attribute has been set cannot be deleted. Delete them with a computer or other means.

Copying Data

Files and folders can be copied between a CF card and USB flash drive.

- 1**  **Select the File Screen.**

- 2**  **Select a folder or file to copy.**

 **Apply**

- 3**  **Select [Copy].**

 **Apply**

- 4**  **Select the copy destination folder.**

 **Apply**

A confirmation dialog is displayed.
Select **[Yes]** and press ENTER to execute the copy operation.

What if the file I want to copy is not displayed?

See: "Switching removable storage" (p. 105)



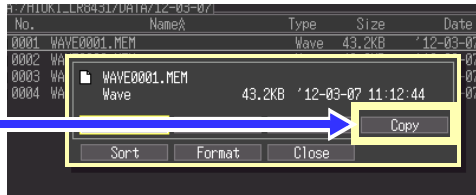



See: "Viewing Folder Contents and the Parent Folder" (p. 106)



- NOTE**
- Folder copying is supported for up to eight hierarchical levels. Folders more than eight levels deep cannot be copied.
 - A file cannot be copied if one with the same name already exists at the destination.

Sorting Files

Files can be sorted in ascending or descending order according to a selected sort key.

- 1  Select the File Screen.
- 2  Apply
The control dialog box appears.
- 3  Select [Sort].
- 4  Apply
Select the key on which to sort.
- 5  Apply
Select the desired sort order.
(Ascending or Descending)
Files are displayed in the new sort order
- 6  Finish

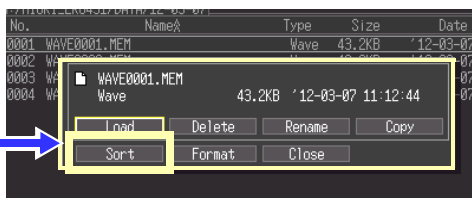

6.6 Transferring Data to a Computer (USB Drive Mode)





Data saved to a CF card can be transferred to a computer using the supplied USB cable.

Before connecting the USB cable to the instrument, set the USB mode on the [System] screen to [USB Drive].

To analyze data with the supplied Logger Utility program, refer to the program's instruction manual on the CD.

See: Appendix 9, "Using the Application Program" (p. A19)

Select the USB Drive Mode

- 1  Select the [System] Screen.
- 2  Select [USB Drive] on the USB mode pull-down menu.
 Apply
 A confirmation dialog appears.
- 3  Select [Yes].
 Apply
 The USB Drive Mode is enabled.

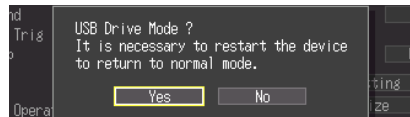
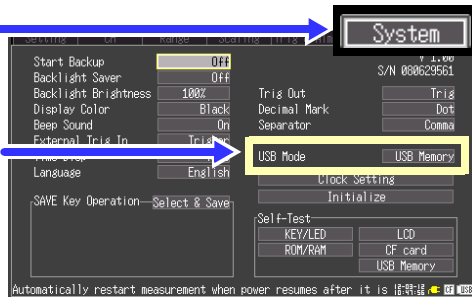

No other HiLogger operations are available when the USB Drive Mode is enabled. Also, HiLogger communications with the supplied Logger Utility program are disabled.

See: "To exit USB Drive Mode" (p. 111)

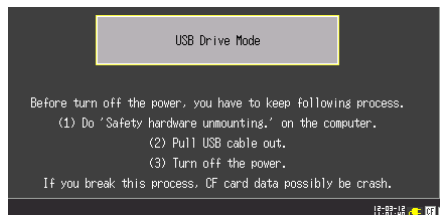

- 4 Connect the USB cable (p.111)

Connecting the USB Cable

Compatible OS: Windows XP, Windows Vista[®], Windows 7 or Windows 8, Windows 10

CAUTION

- Do not eject the CF card or pull out the USB cable during data transfer. Doing so would prevent proper data transfer.
- The Memory HiLogger and computer should be connected to the same earth ground. If grounded separately, potential difference between the ground points can cause malfunctions or damage when connecting the USB cable.

Before connecting the USB cable to the instrument, set the USB mode on the [System] screen to [USB Drive].
Otherwise, the HiLogger's CF card cannot be accessed.



- 1** Orient the USB cable plug properly, and insert it into the receptacle.

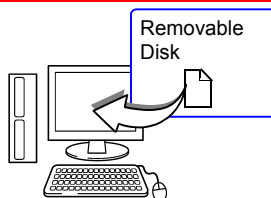

- 2** Connect the other end of the cable to a USB port on the computer.
The computer should recognize the Memory HiLogger as a removable disk when the cable is connected.

To exit USB Drive Mode

6.6 Transferring Data to a Computer (USB Drive Mode)

- 1** Click the Safely Remove Hardware () icon in the Windows[®] notification area.
- 2** Click the appropriate line “Safely remove USB Mass Storage Device – Drive(H:)” where H is the drive letter that Windows[®] assigned to the HiLogger.
- 3** When “Safe to remove hardware” appears, click **[X]** or **[OK]**.
- 4** Disconnect the USB cable.
- 5** Turn the HiLogger off and back on.



Numerical Calculations

Chapter 7

7.1 Calculation Methods

Calculations can be applied to measured data. Six types of numerical calculation are available, four of which can be applied at the same time. Refer to 7.2, "Numerical Value Calculation Expressions" (p. 117) for details of the calculation methods. You can specify the measurement time span over which calculations are to be applied (p. 116).

Types of calculations

- Average value Average value of waveform data
- Peak value Peak-to-peak value of waveform data
- Maximum value Maximum value of waveform data
- Minimum value Minimum value of waveform data
- Time to maximum value Time elapsed from the start of measurement to the maximum value
- Time to minimum value Time elapsed from the start of measurement to the minimum value

Two methods are available for applying calculations, as follows.

Auto Calculation

Configure numerical calculations before starting measurement. Calculations are performed automatically after measurement (p. 114).



(Setting Screen)
Set Numerical Calculation to [On],
and select the calculation types

To save calculation results automatically
(Setting Screen)
Enable Auto Save (p. 97)



Start and finish measuring

Analyze (p. 81)

Calculating After Measuring

Configure numerical calculations after measurement (p. 115).

End of Measurement



(Setting screen or Waveform screen)
Set Numerical Calculation to [On],
and select the calculation types.







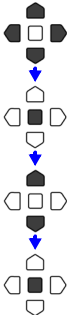
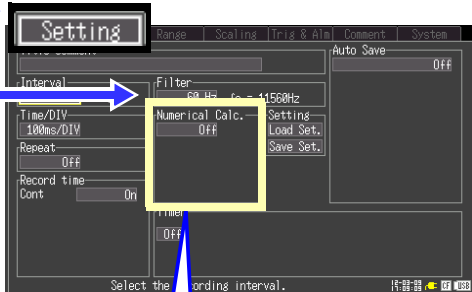
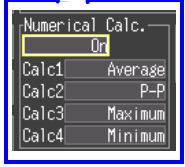

(Waveform Screen)
Execute Calculations

Analyze (p. 81)

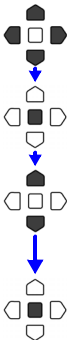
Auto Calculation

Numerical calculations are performed automatically after measurement.

- 1**  Select the **[Setting]** Screen.
- 2**  Select **[NumericalCalc.]**.
 Open the setting options for the item to be set.
 Select **[On]**.
 Apply
- 3**  Select any of **[Calc1]** to **[Calc4]**.
 Open the setting options for the item to be set.
 Select the calculation type.
 Calculation types:
Average, P-P, Maximum, Minimum, Time To Max., Time To Min.,
 (or **Off**, the default)
 Apply
- 4** Enable Auto Save (if automatic saving is needed)
 "Automatic Saving" (p. 97)
- 5**  Start and finish measuring.
- 6** Analyze (p. 81)
 The results of numerical calculations are displayed on the Waveform screen.

Manual Calculation

1 **START/STOP** Start and finish measuring.

2 **WAVE/DATA SET FILE**
 Select the Waveform Screen.
 You can select it from the [Setting] screen.

3 Select **[Wave+Calc]** display.

4 Enable (set to **[On]**) numerical calculation.

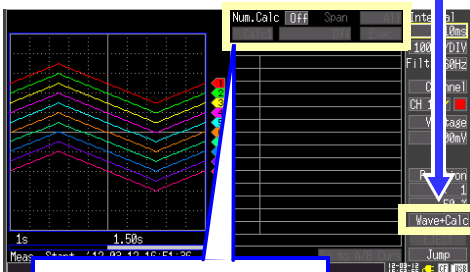

5 **Calc1 to Calc4** Select **[Calc1]** to **[Calc4]** and move to the setting options.
 Open the setting options for the item to be set.

Select the calculation type.
 Calculation types:
Average, P-P, Maximum, Minimum, Time To Max., Time To Min.,
 (or **Off**, the default)
 Apply

Num. Calc	On	Span	All
Calc1	Average		Exec
Calc Result, Calc1			
CH 1			0.025V
CH 2			0.02V
CH 3			0.015V

6 Select **[Exec.]**.

Apply

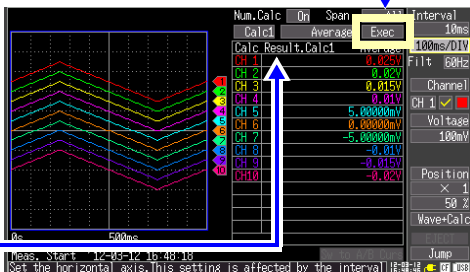



7 Analyze (p. 81)
 The results of numerical calculations are displayed.
 The displayed calculation results are determined by the selected calculation number.

Apply Calculations to a Specific Time Span (Manual Calculation Only)

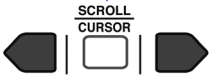

After measuring, calculation can be applied to a specified time span. Make any other calculation settings before specifying the calculation time span (p. 115).

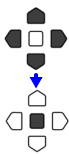

1  Display A/B Cursors.

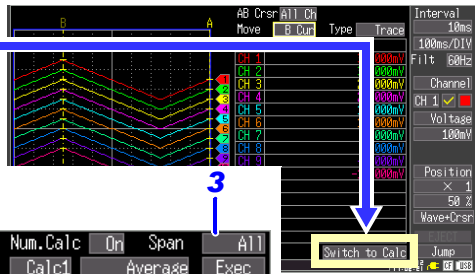
 Position the A/B cursors to define the calculation time span.
To select which cursor to move: (p. 86)

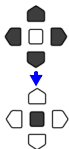

2  Select **[Switch to Calc]**.
 Apply

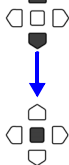

3  Select the **[Span]** setting option
 Open the setting options for the item to be set.

 Select the calculation time span
All, A-B, Start-A, Start-B, A-End, B-End
 Apply

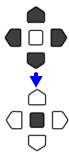
- **All:** The entire acquired waveform
- **A-B:** The time span between cursors A and B
- **Start-A:** From the start of the acquired waveform to cursor A
- **Start-B:** From the start of the acquired waveform to cursor B
- **A-End:** From cursor A to the end of the acquired waveform
- **B-End:** From cursor B to the end of the acquired waveform

4  Select **[Exec]**.
 Apply

The results of calculations are displayed.

When you select [Switch to Calc] the calculation display screen appears, and A/B cursor motion is enabled. However, changing to the [Wave+Calc] display hides the A/B cursors (so they are not movable), although the calculation range can still be changed.

7.2 Numerical Value Calculation Expressions

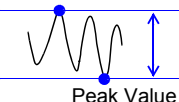
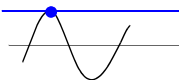
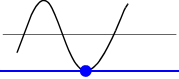
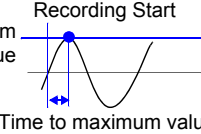
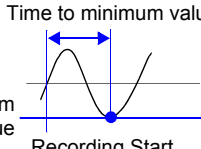
Average	$AVE = \frac{1}{n} \sum_{i=1}^n di$	Obtains the average value of waveform data. AVE: Average value n : Data count di : Data on channel number i
Peak Value (P-P)		Obtains the value of the difference (peak-to-peak value) between maximum and minimum values of waveform data.
Maximum Value		Obtains the maximum value of waveform data.
Minimum Value		Obtains the minimum value of waveform data.
Time to maximum value		Acquires the time (s) elapsed from the start of recording to maximum value. When there are two or more maxima, this value is the first to occur.
Time to minimum value		Acquires the time (s) elapsed from the start of recording to minimum value. When there are two or more minima, this value is the first to occur.

System Environment Settings

Chapter 8

Settings affecting the clock, SAVE key operation and self testing are made from the System screen.

Screen and Key Operation Settings

- Specify operating behavior when recovering from power outages (Start Backup) (p. 120)
- Set backlight power saving (p. 121)
- Set backlight brightness (p. 120)
- Select black or white screen background (p. 121)
- Enable or disable the beeper (p. 121)
- Set the horizontal axis (time value display) (p. 122)
- Select display language (p. 122)

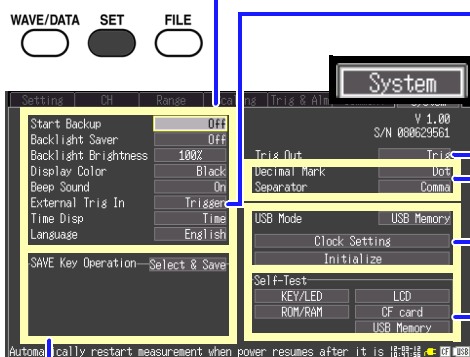

External Control Terminals

- Select external triggering (p. 131)
- Insert event marks by external input (p. 89)
- Set the trigger output (p. 132)

CSV File Saving

- Select CSV file data decimal and separator characters (p. 123)

System-Related Settings

- Set the clock (p. 124)
- Reinitialize the Memory HiLogger (p. 125)
- Transfer data (p. 110)
- Switch the USB mode (p. 126)

Self Testing

- KEY/LED test (p. 127)
- LCD test (p. 127)
- ROM/RAM test (p. 127)
- CF card test (p. 127)
- USB memory check (p. 127)

Save (Storage) Settings (SAVE key)

- Select the saving method for the SAVE key (p. 98)

(for [Quick Save])

- Select the type of data to save (p. 99)
- Select the time span to save (p. 99)

8.1 Screen and Key Operation Settings

1 **WAVE/DATA** **SET** **FILE**
Select the **[System]** Screen.

2 Move to a setting item.

Open the setting options for the item to be set.

Select from the listed options.

Apply

Using the Auto-Resume Function (Resume After Power Restoration)

If a power outage or other power loss causes an interruption in recording (while the LED on the left side of the **START/STOP** key is lit), you can automatically resume recording when the power is restored. If you are using triggers, the triggers are restored to the [Waiting for trigger] state.

NOTE Bear in mind that data on the CF card or USB flash drive can be lost if power is disrupted while writing to it.

Select from the **[Start Backup]** setting options.

Setting options:(* default setting)

- Off*** Do not use the Auto-Resume Function.
- On** Use the Auto-Resume Function.

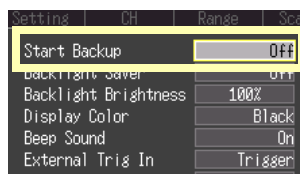

Adjust Backlight Brightness

Backlight brightness can be selected from four levels. Lower brightness settings provide longer battery operating time.

When the **[Backlight Brightness]** setting is selected, pressing the **ENTER** key repeated cycles through the four brightness levels.

Setting options: **100%***, **70%**, **40%**, **25%** (four-step brightness setting) (* default setting)

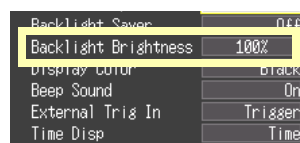

Enabling and Disabling the Backlight Saver

A backlight saver can be activated after a specified number of minutes during which no operation key is pressed. The backlight saver turns off the backlight of the LCD, prolonging the lifetime of the backlight by turning it off when not needed.

To deactivate the backlight saver, press any key. The operating screen appears again.

While the backlight saver is active, the Memory HiLogger's measuring state is still indicated by the LED (lights green when measuring, and blinks when not measuring).

Select from the **[Backlight Saver]** setting options.

Setting options:(* default setting)

Off* Disables the backlight saver function. The operating screen is always displayed.

1min, 2min, 3min, 4min, 5min The backlight saver is activated if the specified time is exceeded.

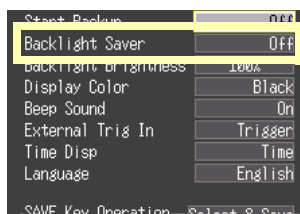

Be aware that power is still consumed even when the backlight is off, so be sure to turn the Memory HiLogger power switch off when not in use.

Selecting Black or White Screen Background

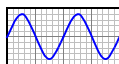
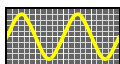

Black Background White Background

The screen background can be set to black or white.

Select from the **[Display Color]** setting options.

Setting options:(* default setting)

Black* Make background black

White Make background white.

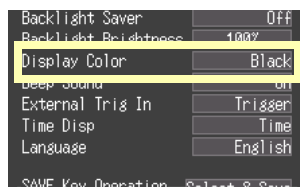

Enabling or Disabling the Beeper

The beeper can be set to sound when an error occurs.

Select from the **[Beep Sound]** setting options.

Setting options:(* default setting)

On* Emit a beep sound on error messages (error and warning displays).

Off Do not emit beep sound.

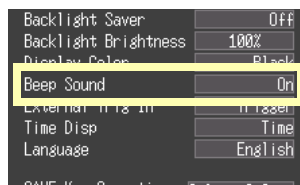

8.1 Screen and Key Operation Settings

Selecting the Horizontal (Time) Axis Display

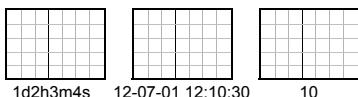

Select the display method for the horizontal axis at the bottom of the screen.

Select from the **[Time Disp]** setting options.

Setting options:(* default setting):

- Time*** Displays the time span from the start of measurement. If triggering is enabled, the displayed time span is from the last trigger event.
- Date** Displays the date and time of data acquisition.
- Data Pts** Displays the number of data points from the start of measurement. If triggering is enabled, the displayed data points begin from the last trigger event.

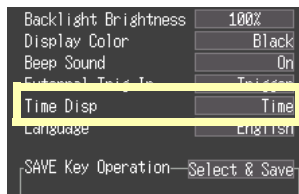

Selecting the Display Language

Select the display language.

Select from the **[Language]** setting options.

Setting options:(* default setting)

- English*** Display in English.
- Japanese** Display in Japanese.

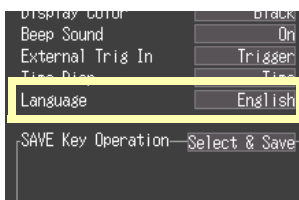

8.2 CSV File Saving Settings

CSV File Data Decimal and Separator Characters

Select decimal point and separator characters for CSV file data.

Select from the **[Decimal Mark]** setting options.

Setting options:(* default setting)

Dot* Select the period character.

Comma Select the comma character.

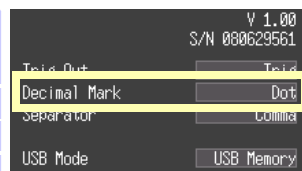

Select from the **[Separator]** setting options.

Setting options:(* default setting)

Comma* Select the comma character.

Space Select the space character.

Tab Select the tab character.

Semicolon Select the semicolon character.

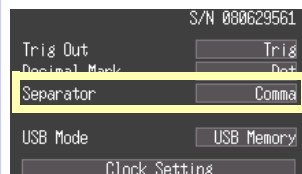

NOTE The comma character cannot be selected for both decimal point and separator at the same time. By default, comma is the separator character, so it is not available as the decimal character. To select comma as the decimal character, first select a different separator character.

8.3 Making System Settings

Setting the Date and Time

The LR431-20 is equipped with an auto-calendar, automatic leap year detection, and a 24-hour clock.

If the clock is not set to the correct time, measurement start time (trigger time) and file date information will be incorrect. If this occurs, reset the clock.

- 1**  Select the **[System]** Screen.

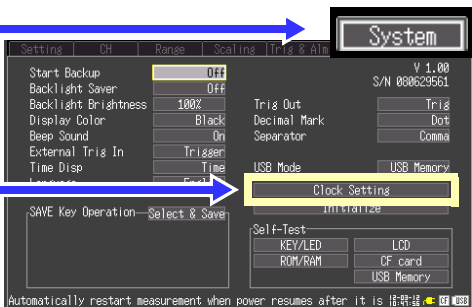
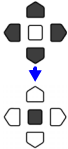

- 2**  Select **[Clock Setting]**.

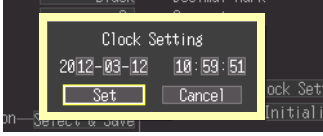
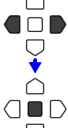
 Apply
The setting dialog appears.



- 3**  Select an item to change.
(year, month, day, hour, minute or second)



 Apply

 Adjust the setting.

 Apply

 Apply

 Change 1's digit

 Change 10's digit
- 4**  Select **[Set]**.

 Apply

The clock is reset.

Initializing the Memory HiLogger (System Reset)

This procedure resets all settings to their factory defaults.

The system is reset by pressing and holding the **START/STOP** key while turning the Memory HiLogger POWER switch on.

For details about the factory default settings, see Appendix 5, "List of Default Settings" (p. A10).

1 **WAVE/DATA** **SET** **FILE**



Select the **[System]** Screen.

2

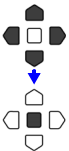

Select **[Initialize]**.

Apply

A confirmation dialog appears.

3

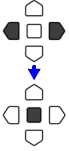

Select **[Yes]**.

Apply

Initialization proceeds.

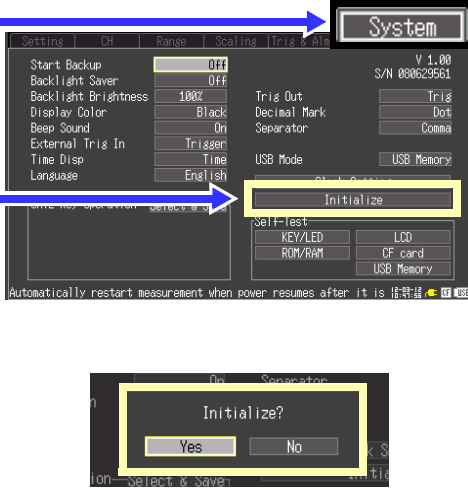

Settings stored in the instrument's memory and language and USB mode settings will not be reset.

Initializing all settings (reset all)

- If you wish to reset settings stored in the instrument's memory as well as language and USB mode settings, turn on the instrument while holding down the **SAVE** key and the **START/STOP** key.
- When the power is switched on, the language selection screen will display for you to choose the language you wish to use.
- After resetting all settings, the USB mode will be set to USB Memory.

Switching the USB mode

Three USB modes are available: [USB Memory], [USB Communication], and [USB Drive].

NOTE Before changing the USB mode, disconnect both the USB communication cable and the USB flash drive from the instrument. Failure to do so will cause a message warning you to eject the devices to appear on the screen.

1 Select the **[System]** Screen.

2 Select **[USB Memory]**, **[USB Communication]**, or **[USB Drive]** from the pull-down menu.

Apply
A confirmation dialog appears.

3 Select **[Yes]**.

Apply

[USB Memory]

[USB Communication]

[USB Drive]

NOTE

USB method of use	Connector used	[System] screen USB mode setting
Use a USB flash drive.	Type A	USB Memory (Default)
Communicate with the LR8431-20 and initiate measurement using the Logger Utility software from a computer (using a USB cable).	Type B	USB Communication
Read files on a CF card that is connected to the LR8431-20 from a computer (using a USB cable).	Type B	USB Drive

Self-Test

The following self tests are available. Results are displayed on the screen. If any faults are found, have the Memory HiLogger repaired. Contact your dealer or Hioki representative.

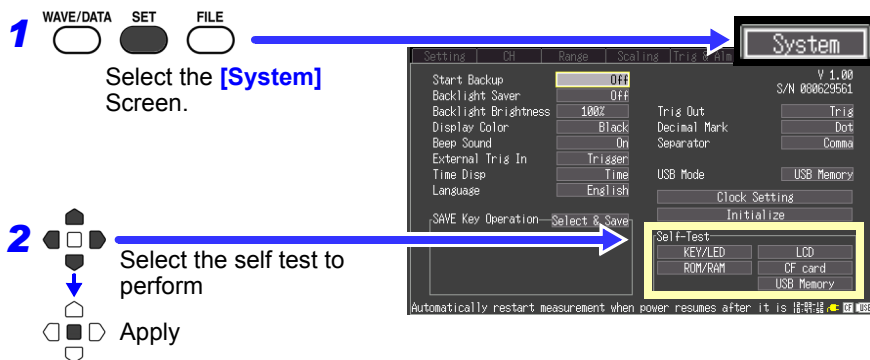

Self-Test	Details
KEY/LED	<p>Tests the keys and LEDs for correct operation. After every key has been pressed, the KEY/LED check finishes. Pressing the START/STOP key also tests whether the LED lights.</p> <p>If you notice a malfunction, press the SAVE and START/STOP keys simultaneously to abort the test.</p>
LCD	<p>Tests the screen display (color test, gradation test, character test) The screen changes each time you press an operation key.</p> <p>If the display screen seems abnormal, request repairs.</p>
ROM/RAM	<p>Tests the instrument's internal memory (ROM and RAM) If "NG" appears, request repairs.</p>
CF card	<p>Tests whether the Memory HiLogger recognizes the inserted CF card. The CF card is formatted (p. 95)</p>
USB Memory	<p>Tests whether the inserted USB flash drive is recognized by the HiLogger.</p> <p>When the USB flash drive is recognized by the instrument, its capacity and peak current consumption will be displayed.</p>

External Control

Chapter 9

The external control terminals on the Memory HiLogger support trigger signal input and output.

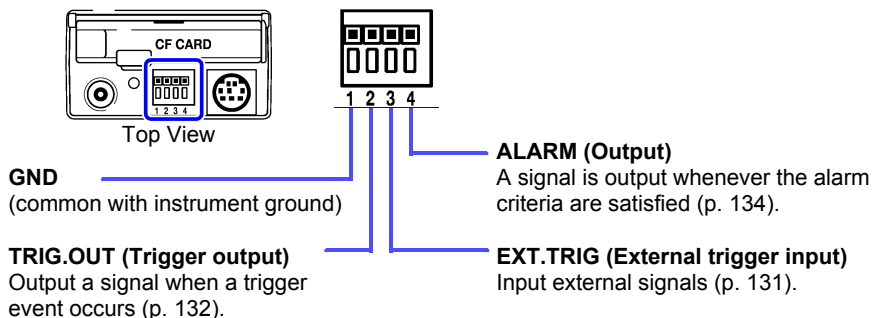

9.1 Connecting to the External Control Terminals



To avoid electrical hazards and damage to the instrument, do not apply voltage exceeding the rated maximum to the external control terminals.

	I/O terminals	Maximum input voltage
Input	EXT.TRIG	0 to 7 V DC
Output	TRIG.OUT	30 V DC
	ALARM	5 mA max, 200 mW max



To prevent electric shock accidents and damage to the equipment, always observe the following precautions when making connections to external terminal blocks and external connectors.

- Before making connections, turn off the power on the instrument and the equipment to connect.
- Do not exceed the specified signal levels for signals supplied to external terminal blocks.
- Ensure that devices and systems to be connected to the external control terminals are properly isolated.

9.1 Connecting to the External Control Terminals



- The external control ground terminal is not isolated from the Memory HiLogger's chassis ground. Make certain that there will be no potential difference between the external control ground terminal and the ground of any connected device. Otherwise, the Memory HiLogger or device could be damaged.
- To avoid electric shock, use the recommended wire type to connect to the external control terminals, or otherwise ensure that the wire used has adequate current-handling capacity and insulation.

Terminal Connections

Required items:

Recommended cables:

Single strand diameter ϕ 0.65 mm (AWG22),

Multi-strand ϕ 0.32 mm² (AWG22)

Usable cables:

Single strand diameter ϕ 0.32 to 0.65 mm (AWG28 to 22),

Multi-strand 0.08 to 0.32 mm² (AWG28 to 22)

Strand diameter ϕ 0.12 mm or greater (per wire)

Standard insulation stripping length: 9 to 10 mm

Button operation specified tool: Flat-blade screwdriver
(shaft diameter ϕ 3 mm, tip width 2.6 mm)

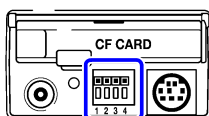
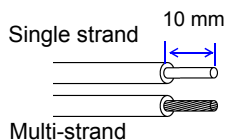

Top View

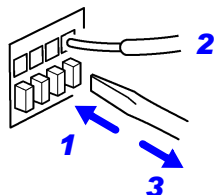

- 1** Push in the button on the connector with a flat-blade screwdriver or other tool.
- 2** With the button held in, insert the cable into the cable connection hole.
- 3** Release the button.
The cable is locked.

9.2 External Trigger Input

Triggering can be controlled by applying a signal from an external trigger source. This allows synchronous operation of multiple Memory HiLoggers by parallel triggering (p. 135).

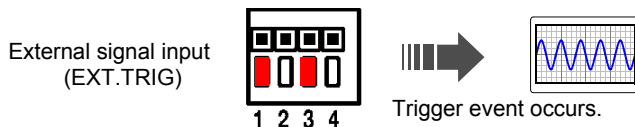

Trigger Input Signals

Voltage range	HIGH level: 3.0 to 5.0 V, LOW level: 0 to 0.8 V
Pulse width	HIGH level: 1 ms or greater, LOW level: 2 μ s or greater
Maximum input voltage	0 to 7 V DC

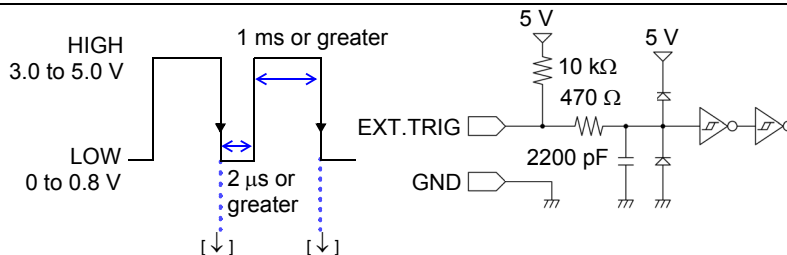

Signal Input Procedure

- 1 Connect the external trigger signal source and signal ground to external control terminals 3 (EXT.TRIG) and 1 (GND), respectively.
- 2 Press the **SET** key to open the **[System]** screen.
- 3 Set the **[External Trig In]** setting to **[Trigger]** (default setting).
- 4 Open the **[Trig & Alm]** screen, and set the **[Trig Func]** to **[On]**.
- 5 Specify trigger start and stop times by the **[Timing]** settings, as needed.
- 6 Set the **[Ext Trig] - [Start]** and **[Stop]** settings to **[On]**.
- 7 Either short the EXT.TRIG terminal to ground, or apply a pulse train (rectangular wave) to the EXT.TRIG terminal, with 3.0 to 5.0 V High and 0 to 0.8 V Low levels. Triggering occurs on the falling edge of the input waveform.

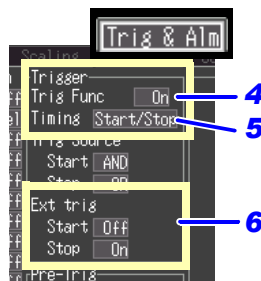
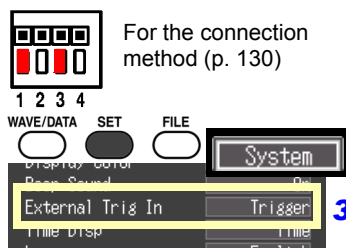

9.3 External Signal Output (Trigger Output)

You can output a signal when a trigger event occurs. This allows synchronous operation of multiple Memory HiLoggers by parallel triggering (p. 135)



Trigger Output Signals

Output signal	Open collector output (with voltage output), active LOW
Output voltage range	HIGH level: 4.0 to 5.0 V, LOW level: 0 to 0.5 V
Pulse width	LOW level: 10 ms or greater
Maximum input voltage	30 V DC, 50 mA max, 200 mW max

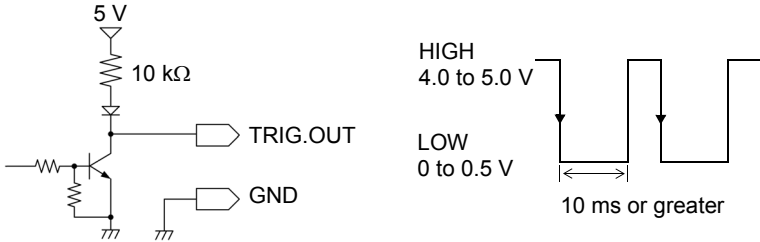

NOTE When triggering is not otherwise used, a trigger signal is output during measurement.

Signal Output Procedure

- 1 Connect the external trigger signal destination and signal ground to external control terminals 2 (TRIG.OUT) and 1 (GND), respectively.
- 2 Press the **SET** key to open the [System] screen.
- 3 Select from the [Trig Out] settings.



For the connection method (p. 130)

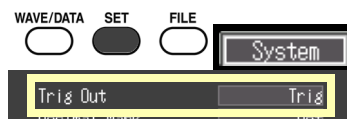

Trig* Output a signal only when a trigger event occurs. The signal outputs synchronized to the setting of the trigger timing.

Start Output a signal even at the start of a measurement that is not a trigger event.

Trigger output setting	Trigger setting	Trigger timing	Trigger output timing
Trig	Disabled	-	no output
	Enabled *1	Start	Start trigger
		Stop	Stop trigger
Start	Disabled	-	Start recording
	Enabled *1	Start	Start trigger
		Stop	Start recording/ Stop trigger
		Start/Stop	Start trigger/stop trigger

*1. Indicates that in trigger function On, the trigger is set at one of the following - analog channel, pulse channel or external trigger.

When a trigger event occurs, a pulse wave changing from the HIGH level (4.0 to 5.0 V) to the LOW level (0 to 0.5 V) is output from the TRIG.OUT terminal.

9.4 Alarm Signal Output (Alarm Output)

This signal is output when alarm criteria are satisfied. Specify the desired alarm criteria.

See: 4.2, "Alarm Output" (p. 73)

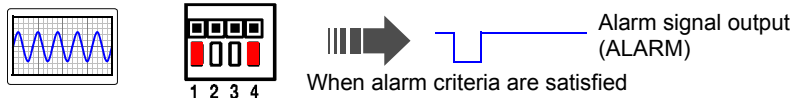

About the Alarm Output Signal

Output signal	Open-drain output (with voltage output), active LOW
Output voltage range	HIGH level: 4.0 to 5.0 V, LOW level: 0 to 0.5 V
Output Refresh	Every recording interval
Maximum input voltage	30 V DC, 5 mA max, 200 mW max

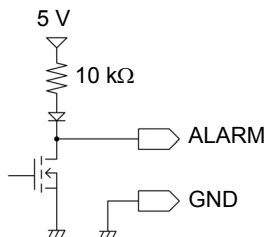

Connect the ALARM (No. 4) and GND (No. 1) terminals of the external control terminal block to the signal output line and ground, respectively. When the alarm criteria are satisfied, a Low level (0 to 0.5V) signal is output.



For the connection method (p. 130)

ALARM pin circuit architecture and example relay connection

The ALARM pin implements active-low operation. In the example connection, current flows to the coil when there is no alarm output. Choose a relay with a contact architecture that implements the desired operation.

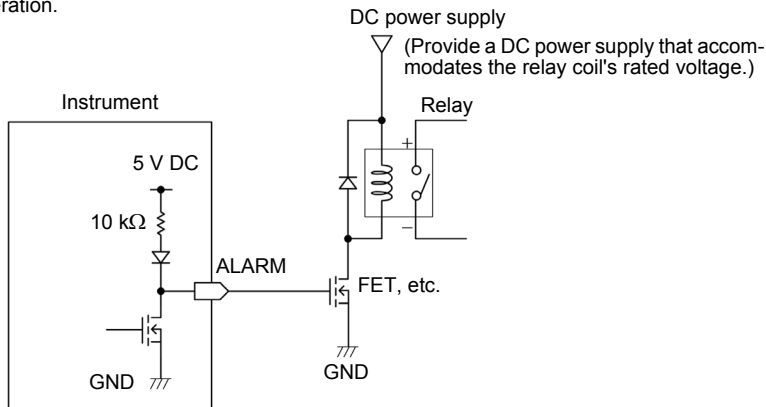

9.5 Synchronous Measurements with Multiple Instruments

Multiple instruments can be synchronized using the external control terminals.

Parallel synchronization

Set one instrument to master, and set the others to slave.

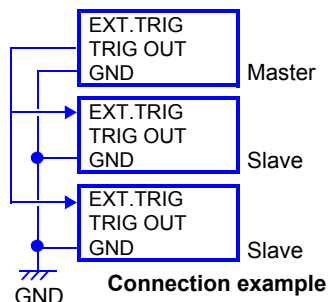

Set the master instrument.

- 1** Press the **SET** key to open the [System] screen.
- 2** Set the [Trig Out] setting to [Start].

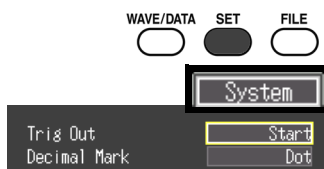

Set the slave instrument.

- 1** Press the **SET** key to open the [System] screen.
- 2** Set the [External Trg In] setting to [Trigger].
- 3** Press the **SET** key to open the [Trig&Alm] screen.
- 4** Set as follows.
 - Trig Func: On**
 - Timing: Start**
 - Trig Source Start: OR**
 - Ext trig Start: On**

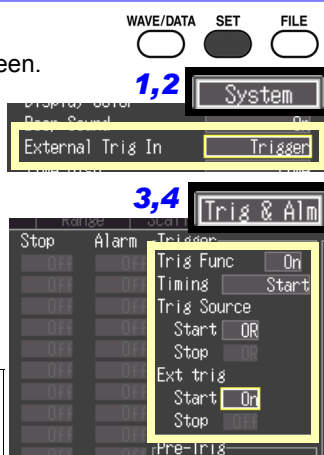

Turn the start trigger setting for all the channels (analog, pulse) to **Off**. Failure to do so may start the measurement without synchronization.

Press the **START/STOP** key of the slave instrument to start the measurement (trigger waiting state). In this state, press the **START/STOP** key of the master instrument to start the measurement. The slave instrument will start the measurement at the same time.

Specifications Chapter 10

(1) General Specifications

Basic Specifications

No. of channels (max.)	10 analog channels + 4 pulse channels Standard product configuration. Pulse grounds share common ground with instrument.
Internal memory capacity	Total 3.5 MW (mega words)
Maximum sampling rate	10 ms/All channels
Timebase accuracy	±0.01%
External terminals	External Trigger Input, Trigger Output, Alarm Output and GND
Clock functions	Auto calendar, auto leap year judgment, 24-hour timer Accuracy: ±50ppm (0°C to 40°C), Nominal value: ±10ppm (25°C)
Backup battery life	Approx. five years for clock and settings (@25°C, 77°F)
Conditions of guaranteed accuracy	After 30 minutes warm-up Defined after zero adjustment has been performed.
Operating temperature and humidity	0 to 40°C (32 to 104°F), 80% RH or less (non-condensating)
Temperature and humidity range for guaranteed accuracy	Temperature 23±5°C (73±9°F), Humidity 80% RH or less (non-condensating)
Storage temperature and humidity	Temperature -10 to 50°C (14 to 122°F), Humidity 80% RH or less (non-condensating)
Period of guaranteed accuracy	1 year
Product warranty period	3 years AC adapter: 1 year Connector, cable, etc.: Not covered by the warranty
Operating environment	Indoors, Pollution degree 2, up to 2000 m (6562-ft.) ASL
Dielectric strength	350 V AC for 15 seconds (between each input channel and chassis, and between input channels)

Basic Specifications

Power source	<ul style="list-style-type: none"> • Model Z1005 AC Adapter Rated supply voltage 100 to 240 V AC Rated supply frequency 50 Hz/60 Hz Anticipated transient overvoltage 2500 V • Model 9780 Battery Pack 3.6 V (Note) The AC Adapter has priority when connected • The external 12 V DC power source (10 to 16 V DC) • (Note) Wiring from the external power to instrument should be no more than 3m long
Maximum rated power	<p>When using the Z1005 AC adapter: 30 VA (including the AC adapter), 10 VA (HiLogger only)</p> <p>When using an external 12 V DC power source: 10 VA</p> <p>When using a 9780 Battery Pack 3 VA</p>
Continuous operating time	When using the Model 9780 Battery Pack and saving data to a CF card, approx. 2.5 hours (@25°C)
Charging function	<p>With the 9780 Battery Pack installed and the AC Adapter connected Charging time: Approx. 200 minutes (@25°C)</p> <p>Note 1. Actual charging time depends on battery condition Note 2. Charging temperature range: 5 to 30°C</p>
Dimensions	Approx. 176W × 101H × 41D mm (sans protrusions) (6.93"W × 3.98"H × 1.61"D)
Mass	<p>Approx. 550g (19.4 oz.) (without Model 9780 Battery Pack)</p> <p>Approx. 620g (21.9 oz.) (With Model 9780 Battery Pack installed)</p>
Effect of radiated radio-frequency electromagnetic field	±5.0%f.s. at 3 V/m
Effect of conducted radio-frequency electromagnetic field	±5.0%f.s. at 3 V
Applicable Standards	<p>Safety EN61010</p> <p>EMC EN61326 Class A</p>

Display Section

Display character	English/ Japanese selectable
Display type	4.3-in TFT Color LCD (480 × 272 dots)
Display resolution	<p>Waveform: Max. 20 divisions (time axis) × 10 divisions (voltage axis)</p> <p>(1 division = 20 dot (time axis) × 20dot (voltage axis))</p> <p>Note: The number of displayed time axis divisions depends on the display configuration.</p>
Dot pitch	0.198mm × 0.198mm
Backlight	On, Off

Display Section

Backlight life span	Approx. 10,000 hours (continuously on)
Backlight saver function	Selectable from on, or auto-off after selectable interval
Backlight brightness	Selectable from four levels (100%, 70%, 40%, 25%)

External Interfaces

USB standard	USB2.0 compliant High Speed
Connector	Series-mini B receptacle
Connecting devices	PC
Function	Supports data acquisition using a data acquisition application program Supports remote setting of measurement criteria using a data acquisition application program Transfer files between an installed CF card and connected PC

External storage

CF card

Slot	One CompactFlash compliant slot CF Card Type I accepted
Card type	Flash ATA card
Card capacities	Model 9727 (256 MB), 9728 (512 MB), 9729 (1 GB), 9830 (2 GB)
Data formats	FAT and FAT32 supported
Storage contents	<ul style="list-style-type: none"> • Setting configurations • Measurement data (binary and csv format) (data between A-B cursors can be saved) • Screen images (compressed bitmap format) • Calculation results

USB flash drive

Supported standard	High-speed USB 2.0
Connector	Series A receptacle
Data format	FAT, FAT32
Storage contents	<ul style="list-style-type: none"> • Setting configurations • Measurement data (binary and csv format) (data between A-B cursors can be saved) • Screen images (compressed bitmap format) • Calculation results Functionality not available when the USB external interface is in use.
Usable device	USB flash drive

CF card/ USB flash drive common functionality

Drive-to-drive copying Files and folders can be copied between drives.

Measurement Input Section

Input terminals M3 screw type terminal block (2 terminals per channel)
Pulse inputs use a special connector

Measurement object

- Voltage
- Thermocouple (K, J, E, T, N, R, S, B)
- Pulse count integration (cumulative and instantaneous), revolution variations

Measurement ranges and resolution

Measurement Object	Range	Measurable Range	Max. Resolution
Voltage	100mV f.s.	-100 mV to +100 mV	5 μ V
	1V f.s.	-1 V to +1 V	50 μ V
	10V f.s.	-10 V to +10 V	500 μ V
	20V f.s.	-20 V to +20 V	1 mV
	100V f.s.	-60 V to +60 V	5 mV
	1-5V	1V to 5V	500 μ V
Temperature (thermocouple)	2000°C f.s.	-200°C to 1800°C *1	0.1°C
Pulse Integration	1,000M pulse f.s.	0 to 1,000M pulse	1 pulse
Revolution Variation	5,000/n r/s f.s.	0 to 5,000/n r/s	1/n r/s
	n = pulses/revolution, from 1 to 1,000		

*1: Upper and lower limits depend on sensor input range

Temperature measurement input range	K: -200°C to 1350°C	J: -200°C to 1200°C
	E: -200°C to 1000°C	T: -200°C to 400°C
	N: -200°C to 1300°C	R: 0°C to 1700°C
	S: 0°C to 1700°C	B: 400°C to 1800°C
	(JIS C 1602-1995)	

Measurement Input Section

Measurement accuracy	<ul style="list-style-type: none"> Voltage: $\pm 0.1\%$ f.s. (For the 1-5V range, f.s = 10 V) Thermocouple: <ul style="list-style-type: none"> K, J, E, T: (-200°C to less than -100°C) $\pm 1.5^\circ\text{C}$ (-100°C or more) $\pm 1.0^\circ\text{C}$ N: (-200°C to less than -100°C) $\pm 2.2^\circ\text{C}$ (-100°C or more) $\pm 1.2^\circ\text{C}$ R, S: (0°C to less than 300°C) $\pm 4.5^\circ\text{C}$ (300°C or more) $\pm 2.2^\circ\text{C}$ B: (400°C to less than 1,000°C) $\pm 5.5^\circ\text{C}$ (1000°C or more) $\pm 2.5^\circ\text{C}$ Reference junction compensation accuracy: <ul style="list-style-type: none"> $\pm 0.5^\circ\text{C}$ (Horizontal placement) $\pm 1^\circ\text{C}$ (Upright placement) (Add to thermocouple measurement accuracy when internal RJC is enabled.) 			
Temperature characteristic	Add (Measurement accuracy \times 0.1) /°C to measurement accuracy			
Reference junction compensation	Internal/External selectable (for thermocouple measurements)			
Digital filter	Off, 50 Hz, 60 Hz (cut-off frequency set automatically according to recording interval)			
Cut-off frequency				
[Hz]				
Recording interval	Digital filter	Recording interval	Digital filter	
	60Hz 50Hz Off		60Hz 50Hz Off	
10ms	11.56k 11.56k	11.56k	1s	108.2 108.2
20ms	5.78k 5.78k		2s	60 54.03
50ms	2.216k 2.216k		5s	60 50
100ms	1.096k 1.096k		10s	60 50
200ms	542.5 542.5		20s or more	10 10
500ms	216.6 216.6			
Input resistance	1 M Ω $\pm 5\%$ (broken wire detection disabled, for voltage and thermocouple measurements) At least 800 k Ω (with broken wire detection enabled for thermocouple measurements)			
Normal mode rejection ratio	50 dB minimum (with 50 Hz input with 5 s recording interval, and 50 Hz digital filter enabled) (with 60 Hz input with 2 s recording interval, and 60 Hz digital filter enabled)			

Common mode rejection ratio	with 100 Ω maximum signal source impedance 100 dB minimum (with 50 or 60 Hz input and digital filter disabled) 140 dB minimum (with 50 Hz input with 5 s recording interval, and 50 Hz digital filter enabled) (with 60 Hz input with 2 s recording interval, and 60 Hz digital filter enabled)
Broken wire detection	(Temperature input) selectable On or Off, approx. 300 nA detection current
Maximum input voltage	30 V rms or 60 V DC (analog input channel)
Maximum rated voltage to earth	30 V rms or 60 V DC (between each input channel and chassis, and between input channels) Anticipated transient overvoltage 330 V
Pulse input	Non-voltage "a" contact (normally open) open collector or voltage input
Maximum input voltage	0 to 10 V DC
Maximum channel-to-channel voltage	Non-isolated (channels use the Memory HiLogger common ground)
Maximum rated voltage to earth	Non-isolated (channels use the Memory HiLogger common ground)
Detecting level	High: 2.5 V min., Low: 0.9 V max.
Pulse input period	At least 200 μ s (both H and L levels at least 100 μ s)
Slope	Either rising or falling edge pulse detection can be set for each channel
Function	Integrated count, revolution variation

(2) Measurement Functions**Basic Specifications**

Recording interval	10, 20, 50, 100, 200 or 500 ms; or 1, 2, 5, 10, 20 or 30 s; or 1, 2, 5, 10, 20 or 30 min; or 1 h
Recording length (time span)	Any, with continuous recording selectable
Recording repetition function	Repeatedly measures using the specified recording length
Timer function	Records between specified start and stop times
Specifiable waveform colors	24 colors

Basic Specifications

Hybrid display configurations	<ul style="list-style-type: none"> • Simultaneous waveform and gauge display • Waveform display • Simultaneous waveform and numerical value display • Simultaneous numerical value and comment display • Numerical value display • Numerical calculation display (simultaneous calculation results and waveforms) • Cursor value display (simultaneous A/B cursor values and waveforms)
Waveform compression and magnification	<ul style="list-style-type: none"> • Time axis (horizontal axis) 100 ms, 200 ms, 500 ms, 1 s, 2 s, 5 s, 10 s, 20 s, 30 s, 1 min, 2 min, 5 min, 10 min, 20 min, 30 min, 1 h, 2 h, 5 h, 10 h, 12 h, 1 day/division • Voltage axis (vertical axis) ×100, ×50, ×20, ×10, ×5, ×2, ×1, ×1/2 (switchable to upper and lower limit settings)
Waveform scrolling	Horizontal scrolling
Waveform storage	The last 3.5 M data points (recording time for one analog channel) are stored in internal memory. Data retained in memory can be observed by backward scrolling.

Trigger Section

Trigger method	Digital comparison
Trigger timing	Start, stop, start&stop
Trigger source	Analog input (CH1 to 10), Integrated pulse input (P1 to 4)
External trigger	Triggering occurs when the external trigger and ground terminals are shorted, or on falling edges from High (3 to 5 V) to Low (0 to 0.8 V) levels. Maximum input voltage: 0 to 7 V DC Minimum response pulse width: 1 ms H, 2 μs L
Trigger criteria	AND or OR of each trigger source, Trigger criteria can be set for each channel.
Trigger types (analog and pulse)	<ul style="list-style-type: none"> • Level Trigger Triggering occurs when the signal rises (or falls) through a specified value. • Window Trigger Triggering occurs when the input signal level enters or exits the amplitude window defined by upper/lower thresholds.
Trigger level resolution	Analog channel: 0.025% f.s. (f.s. = 10 divisions) Pulse channel: 1c (Pulse count integration), 1/n r/s (revolution) n = pulses/revolution
Pre-trigger	Time span setting (any span). Settable with real-time saving.

Trigger Section

Trigger output	Open-collector output (with 5 V output, Active Low) Pulse Width: at least 10 ms You can choose to enable output at trigger activation only or at both trigger activation and measurement start.
Trigger input and output terminals	Push-button terminals

Alarm Output

Output settings	OR, AND Output occurs when the logical sum (OR) or product (AND) of alarm trigger sources is true.
Alarm Types	The following criteria can be specified for each channel. <ul style="list-style-type: none"> • Level : An alarm is output by input rising above or falling below a preset level • Window : An alarm is output by input crossing into or out of a window defined by preset upper and lower trigger levels
Latch setting	Alarm output can be set to be held (latched), or not.
Beeper	On/Off
Alarm output characteristic	Open-drain output (with 5 V pull-up, active low)
Output refresh	At every recording interval

Miscellaneous

Numerical calculations	Four calculations are available at the same time
Calculations	Average value, peak value, maximum value, Time to maximum value, minimum value, Time to minimum value
Calculation time span	Can be specified by A/B cursors, or whole waveform
Cursor measurement functions	Time difference between A/B cursors, potential difference, potential at each cursor, time
Scaling functions	Available for each channel independently
Comment entry	Provided
Event mark insertion	Event markers can be inserted by screen button or by signal input at the trigger input terminal (exclusive function)
Screen image capture function	Provided (compressed bitmap format)
Retain start condition function	Provided

Miscellaneous

Auto save function	Waveform data (real-time), numerical calculation results (after measurement), Power to the instrument must not be interrupted while data is being saved.
Real-time saving	Saves real-time waveform data to CF card in binary or csv format Each recording length can be save in a separate file Overwriting save is available Up to 3.5 M data points in binary format can be loaded from a specified point (using one analog channel) Power to the instrument must not be interrupted while data is being saved.
Auto setup function	Automatically loads settings from CF card at power on
Monitor function	Indicates momentary values without storing data into memory
Waveform backup time function	Memory is retained (backed up) while the Memory HiLogger is turned off when a charged 9780 Battery Pack is present or with the Z1005 AC Adapter connected.
Waveform backup time	100 hours with a 9780 Battery Pack after full charge
Saving of settings	Up to 10 setting profiles can be saved in the instrument's memory.

(3) Miscellaneous

Accessories	<ul style="list-style-type: none"> • Measurement Guide 1 • CD 1 (Instruction Manual (PDF), Logger Utility Instruction Manual (PDF), Logger Utility (Data acquisition application program) • USB cable 1 • Z1005 AC Adapter (with supplied power cord) 1
Options	<ul style="list-style-type: none"> • Model 9780 Battery Pack (Ni-MH, 3.6V, 1500mAh) • Model Z1005 AC Adapter • Model 9782 Carrying Case • Model 9812 Soft Case • Model 9641 Connection Cable (for pulse input) • Model 9727 PC Card (256 MB) • Model 9728 PC Card (512 MB) • Model 9729 PC Card (1 GB) • Model 9830 PC Card (2 GB) • Model 9809 Protection Sheet

Maintenance and Service

Chapter 11

11.1 Troubleshooting

Inspection and Repair



CAUTION Do not attempt to modify, disassemble or repair the instrument; as fire, electric shock and injury could result.



NOTE If damage is suspected, check the "Before Returning for Repair" (p.148) section before contacting your dealer or Hioki representative.

Transporting

- Use the original packing materials when transporting the instrument, if possible.
- Pack the instrument so that it will not sustain damage during shipping, and include a description of existing damage. We cannot accept responsibility for damage incurred during shipping.

Replaceable Parts and Operating Lifetimes

Useful life depends on the operating environment and frequency of use. Operation cannot be guaranteed beyond the following periods



For replacement parts, contact your dealer or Hioki representative.

Part	Life
LCD (to half brightness)	Approx. 10,000 hours
Model 9780 Battery pack	60% of initial battery capacity can be expected to remain after 500 complete charge/discharge cycles.
Battery pack connectors	Disconnection/connection times: 30 (the number of times that provides stable connection)
Electrolytic Capacitors	Approx. 10 years
Lithium Battery	Approx. 5 years The instrument contains a built-in backup lithium battery. If the date and time deviate substantially when the instrument is switched on, it is the time to replace that battery. Contact your dealer or Hioki representative.

The fuse is housed in the power unit of the instrument. If the power does not turn on, the fuse may be blown. If this occurs, a replacement or repair cannot be performed by customers. Please contact your dealer or Hioki representative.

Before Returning for Repair

If abnormal operation occurs, check the following items.

Symptom	Check Items	
The display does not appear when you turn the power on.	<ul style="list-style-type: none"> • Is the power cord disconnected? • Are connections made correctly? • Is the battery pack installed correctly? 	Verify that the power cord is connected properly (p.30). Verify that the battery pack is correctly installed (p.26).
Keys do not work.	<ul style="list-style-type: none"> • Is any key being held down? • Is the key-lock state active? (A message appears when a key is pressed while key-lock is active.) 	Verify key operation. Cancel key-lock: (Hold the   cursor keys for three seconds)
Power does not turn on.	<ul style="list-style-type: none"> • A power protection component may be damaged. 	Customers should not attempt to perform parts replacement and repair. Contact your dealer or Hioki representative for service.
A waveform does not appear when you press the START/STOP key.	<ul style="list-style-type: none"> • Is the "Waiting for pre-trigger" message displayed? • Is the "Waiting for trigger" message displayed? • Is the waveform display color selection box selected ()? 	When pre-triggering is enabled, triggering is ignored until the pre-trigger portion of the waveform has been acquired. Recording starts when a trigger occurs.
No changes occur in the displayed waveform.	<ul style="list-style-type: none"> • Is the measurement cable connected correctly? • Is the measurement range set properly? 	Verify that the clamp sensor or connection cable is connected correctly (p.31).
Data cannot be saved to the removal storage.	<ul style="list-style-type: none"> • Is the removal storage inserted properly? • Is the removal storage formatted? • Is the remaining capacity of the removal storage too low? 	"Using a CF Card/USB flash drive" (p.93)
If the cause is unknown	<ul style="list-style-type: none"> • Try performing a system reset (p.125). • All settings are returned to their factory defaults. Appendix 5, "List of Default Settings" (p. A10) 	

9780 battery pack cannot be charged (CHARGE LED is not lit).	Please confirm that the surrounding temperature is within 5 to 30°C range.	The temperature allowed for charging on the HiLogger is surrounding temperature of 5 to 30°C. (p.26)
	Is the HiLogger stored for a long time in a plugged condition?	The battery pack may have deteriorated and the battery life may be expiring soon. (p.147) Please purchase a new battery pack. Please contact your dealer or the nearest HIOKI representative. If the HiLogger is not used for more than a month, please remove the battery pack for storage. (p.27)
Time that can be used with the battery pack has become shorter.	Possibility of capacity decrease due to the deterioration of the battery pack.	The battery pack may have deteriorated and the battery life may be expiring soon. (p.147) Please purchase a new battery pack. Please contact your dealer or the nearest HIOKI representative.

11.2 Cleaning

To clean the instrument, wipe it gently with a soft cloth moistened with water or mild detergent. Never use solvents such as benzene, alcohol, acetone, ether, ketones, thinners or gasoline, as they can deform and discolor the case.

Wipe the LCD gently with a soft, dry cloth.

11.3 Disposing of the Instrument

The instrument contains a lithium battery for memory backup. When disposing of this instrument, remove the lithium battery and dispose of battery and instrument in accordance with local regulations.

Removing the Lithium Battery



To avoid electrocution, turn off the power switch and disconnect the power cord and cables before removing the lithium battery.

Required tools:

- One Phillips screwdriver (No.1)
- One wire cutter (to remove the lithium battery)

- 1 Verify that the power is off, and remove the measurement cables and power cord.
- 2 Turn the Memory HiLogger over and remove the five screws affixing the lower case.
- 3 Remove the lower case. Then remove the two screws affixing the circuit board, and remove it.

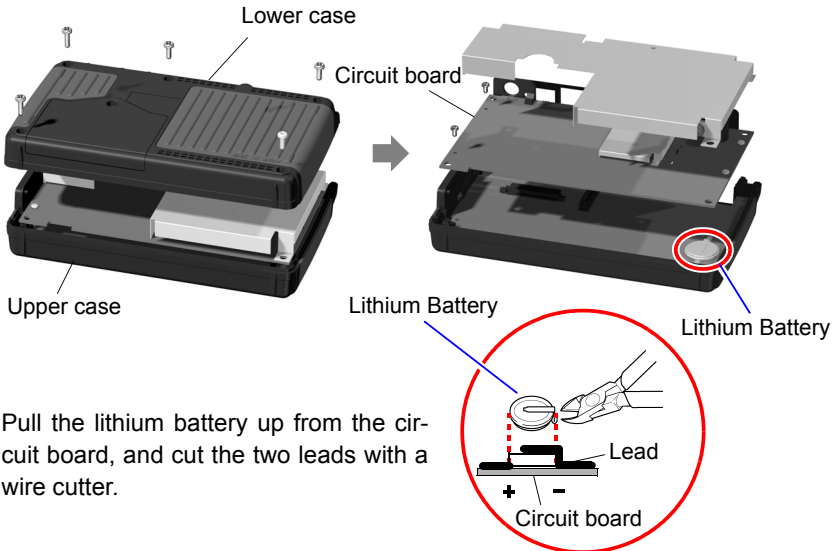

- 4 Pull the lithium battery up from the circuit board, and cut the two leads with a wire cutter.

CALIFORNIA, USA ONLY

This product contains a CR Coin Lithium Battery which contains Perchlorate Material - special handling may apply.

See www.dtsc.ca.gov/hazardouswaste/perchlorate

Appendix

Appendix 1 Error Messages and Remedial Actions

Error messages consist of either "Error" or "Warning" displays. A screen message appears whenever an error occurs. In either case, take the remedial action indicated.

Error Messages



To clear an error message, press the **ENTER** or **ESC** key.

Message	Remedial Action
004 Battery low. Cannot access to the waveform backup and Media.	Low battery charge: recharge or replace with a fresh battery pack.
005 FPGA error.	Incompatible FPGA firmware version. Try updating the firmware, and if the error persists, submit the Memory HiLogger for repair.
013 Failure has been detected on power source for USB memory.	Replace the USB flash drive. If the error persists after replacement, the instrument needs to be repaired.
014 Storage media has been removed without going through a proper [EJECT] process.	When removing storage media during auto save operation, be sure to perform the [Eject] procedure.

Warning Messages

Appears just once when an error occurs. Disappears within a few seconds. Also disappears when any key is pressed.

Message	Remedial Action
101 Invalid key.	The pressed key is disabled due to measuring or other operation. Press the key again after the current operation finishes.
102 Cannot start measurement.	The START/STOP key is disabled when the current screen is displayed. Switch to the Waveform screen before starting measurement.
103 Cannot change while measuring.	Press the START/STOP key to stop measuring before changing the setting.

Appendix 1 Error Messages and Remedial Actions

Message		Remedial Action
201	Exceeding the setting range.	The entered numerical value is out of the valid range. Enter a valid value.
204	Measurement range was changed.	When [Type] - [Range] is selected, the measurement range is automatically changed to match the upper and lower limits.
230	Recording time has been changed due to memory limit.	Increasing the number of measurement channels has decreased Internal memory waveform data capacity.
231	The pre-trigger time setting has been changed.	Increasing the recording interval or length requires reducing pre-trigger recording time.
232	Recording and pre-trigger times have been shortened due to memory limit.	Increasing the recording interval requires reducing recording length and pre-trigger recording time.
233	Trigger or alarm settings for this channel have been changed.	The setting ranges for count integration and revolutions have been changed.
234	The burn out setting has been disabled.	Broken wire detection is disabled (turned Off) when the recording interval is set to 10, 20 or 50 ms, or when the digital filter is disabled.
235	Burn out cannot be enabled with current settings.	Broken wire detection is disabled (turned Off) when the recording interval is set to 10, 20 or 50 ms, or when the digital filter is disabled.
236	File partition period was changed.	The segment time span has been changed in response to changing the recording interval.
237	File partition time was changed.	The segment time span has been changed in response to changing the recording interval.
238	When the record interval is 10ms or 20ms, the CSV automatic saving cannot be set.	To select [CSV (real time)] or [CSV + Calc] for auto saving, the recording interval must first be set to at least 50 ms.
239	Because the CSV automatic saving is set, the record interval cannot be set to 10ms or 20ms.	To select 10 ms or 20 ms recording interval, first select a non-CSV auto saving method.
240	The timer stop time has been passed.	Set the timer stop time to a future time.
301	No waveform data	No waveform data is preset, so data saving and calculations cannot be performed. Press the START/STOP key to start acquiring measurement data.
302	Confirm the A-B cursor position.	The A/B cursor positions are invalid (out of waveform range). Check the cursor positions.
303	No numeric calculation data	Execute numerical calculation (p.113).
304	Invalid event marker.	Try moving to an event mark that is not in memory.

Appendix 1 Error Messages and Remedial Actions

Message		Remedial Action
401	File processing error	An unexpected fault occurred while processing a file on the CF card or USB flash drive. Turn the Memory HiLogger off and back on.
402	Cannot load this file.	The format of the file is incompatible with the Memory HiLogger, or the file is corrupt. Refer to 6.1, "About Saving and Loading Data" (p.91) for loadable file formats.
403	Insert a Media.	A CF card or USB flash drive is not present. Insert storage media.
404	Directory full	No more files can be created because the directory is full. Check or perform the following: 1. System reset (p.125) 2. Verify that the removal storage is specified by Hioki (p.93) 3. Reformat the removal storage (p.95) If the message persists after performing the above, either the removal storage or HiLogger may be damaged. Contact your dealer or Hioki representative.
405	Not enough capacity	The removal storage as insufficient space to save the file. Delete files to increase free space, or replace the removal storage.
406	Process interrupted (not enough battery capacity).	There is inadequate battery life remaining. Charge the battery or connect the AC adapter. If you check the above and find no problem, the CF card or instrument may be broken. Contact your dealer or Hioki representative.
430	Some data was not saved.	The removal storage is not inserted, or does not have enough free space. Insert a removal storage and manually save needed data.
431	Insert media to save waveform data. Insert recording media.	Insert a removal storage.
432	Change media.	Removable storage cannot be accessed. Replace the CF card or USB flash drive.
434	Media is full or cannot delete oldest wave file.	This may appear while measuring using waveform auto save. A file could not be saved: Not enough space on the removable storage.
435	Media is nearly full.	Not enough space on the removal storage. Replace with a new removal storage.
436	Saving interrupted (low battery).	Battery charge is too low to save. Recharge, or connect the AC adapter.

Appendix 1 Error Messages and Remedial Actions

Message		Remedial Action
437	Saving wave data. Please wait for a moment.	Some key operations are disabled because of the increased load during real-time saving. Minimize key operations as much as possible during real-time saving.
438	This folder is protected. Please rename for deleting.	This message is displayed to prevent accidental deletion of data folders. To delete a folder, first rename it.
441	Insert the recording media. Unsaved data will be lost soon.	Real-time saving was attempted without removable storage, and with less than 50% internal memory available. Insert removable storage.
442	File name is too long to change.	The HiLogger cannot rename files with names longer than 26 characters. Use a PC to rename the file.
443	For USB Communication mode, USB memory is not available.	Switch to USB Memory mode on the [System] screen.
450	The save media changed to the CF card.	If the USB flash drive is removed while being used as the save media during auto save operation, the save media will be changed to the CF Card.
451	The save media changed to the USB memory.	If the CF card is removed while being used as the save media during auto save operation, the save media will be changed to the USB flash drive.
501	File system error (I/O error).	An I/O error occurred while accessing the removal storage. Reformat the removal storage. If the error persists, try a different removal storage. If this error occurs while using a good removal storage, the HiLogger may be damaged, in which case contact your dealer or Hioki representative.
502	File system error (Incorrect file handle)	Turn the Memory HiLogger off and back on. If the fault persists, perform system reset (p.125).
503	File system error (system configuration)	
504	File system error (not enough memory)	
505	File system error (incompleted information).	The removable storage could not be recognized. Reformat the removable storage on a PC. If the error persists, try a different removable storage. If this error occurs while using a good removable storage, the HiLogger may be damaged, in which case contact your dealer or Hioki representative.

Appendix 1 Error Messages and Remedial Actions

Message	Remedial Action
506 File system error (incorrect device)	Turn the Memory HiLogger off and back on. If the fault persists, perform system reset (p.125).
507 File system error (file protected)	The requested write process (including deletion) could not be performed because the file attribute is read-only. Use a computer to cancel the read-only setting.
508 File system error (failed to recognize the format).	The removable storage could not be recognized. Reformat the removable storage on a PC. If the error persists, try a different removable storage. If this error occurs while using a good removable storage, the HiLogger may be damaged, in which case contact your dealer or Hioki representative.
509 File system error (limit of the number of files).	The number of files to be processed exceeds the limit, so processing cannot be performed. Delete files to increase free space, or try another removable storage.
510 File system error (same name file)	An attempt was made to create a file with the same name as an existing file. Change the name of the file to be created (p.107).
511 File system error (system busy)	Processing could not be performed because files are in use by another executing process. Wait for the current process to finish. If there is no other executing process, turn the Memory HiLogger off and back on.
512 File system error (too long path name).	The specified path name is too long. Re-enter the name of a removable storage folder from the PC.
513 File system error (no file)	Turn the Memory HiLogger off and back on. If the fault persists, perform system reset (p.125).
514 File system error (mode error)	
515 File system error (invalid file handle)	
516 File system error (file offset error)	
517 File system error (not enough capacity).	Insufficient free space is available on the removable storage for the process to execute. Delete files to increase free space, or try another removable storage.
518 File system error (invalid file name)	The file name contains an invalid character. Rename the file (p.107).

A6

Appendix 1 Error Messages and Remedial Actions

Message		Remedial Action
519	File system error (directory error)	Turn the Memory HiLogger off and back on. If the fault persists, perform system reset (p.125).
520	File system error (invalid file type)	
521	File system error (file rename error)	
522	File system error (internal parameter error)	
523	File system error (block size error)	
524	File system error (semaphore error)	
525	File system error (not supported action)	
680	Now in USB Communication mode. Do not connect anything to USB memory receptacle. (You can choose USB mode on the System screen.)	Disconnect the USB flash drive from the instrument. To use a USB flash drive, set the USB mode setting on the [System] screen to [USB Memory] and then connect the USB flash drive.
681	Now in USB Memory mode. Do not connect anything to USB cable receptacle. (You can choose USB mode on the System screen.)	Disconnect the USB communication cable from the instrument. To use USB communication functionality, set the USB mode setting on the [System] screen to [USB Communication] and then connect the USB communication cable.

Appendix 2 File Naming

File names are constructed as follows (must be exactly eight characters, not including extension).

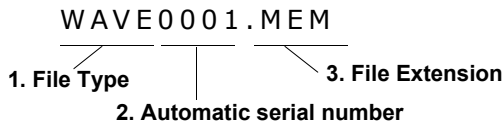

File Type	Folder Name	1. File Type	2. Automatic serial number	3. File Extension
Settings Data	CONFIG	CONF	0001,... 999999999	.SET
Waveform Data	DATA (Folders named by date are automatically created) *2	Manual Save: WAVE Auto Save: (specified name) or AUTO	0001, ...999999999 *1	.MEM (Binary) .CSV (Text) *3, 4
Numerical Calculation Results	MEASUREMENT	Manual Save: MEAS Auto Save: (specified name) or AUTO	0001, ...999999999	.CSV *3, 4
Captured Screen Image	PICTURE	SCR	00001...999999999	.BMP

*1 When auto saving waveform data and calculation results, automatically generated serial numbers (up to eight digits) are appended to the specified file name. If no file name is specified, AUTO is automatically entered.

(XXXX0001.MEM, XXX00001.MEM, XX000001.MEM, X0000001.MEM)

When auto numbering exceeds 9999, the file name characters are overwritten (right to left) until all eight digits are used for serial numbers.

(Example: WAVE9999.MEM, WAV10000.MEM, ..)

*2 When [Deleting] is enabled with auto save, the oldest waveform file is deleted when the CF card is full. When all waveform files within a date folder have been deleted, the folder name (date) is automatically updated.

(Example:) Before updating: 12-07-17

After updating: 12_07_17_120719_101113 (*old date_new date_new day and time*)

Hyphens (-) are changed to underbars (_) and the date when the folder name was last changed is appended.

(The example shows a new date and time of July 19th 2012, 10:11:13.)

*3 The TXT file extension is applied except when **[Separator:Comma]** is selected on the **[System]** screen.

*4 Before loading data into a spreadsheet program such as Excel[®], note that the number of rows that can be loaded at one time is limited (to 60,000 rows in Excel 97 – 2003, and to one million rows in Excel 2007).

Larger CSV files can be split by the following methods:

- Use a CSV file-splitting program (downloadable for free from Hioki's website).
- Before saving, select the [Split Save] saving method in the HiLogger.

Note: The number of rows recorded per minute with 10 ms recording interval is:

100 (data points per second) x 60 (seconds) = 6,000 rows

Appendix 3 Text File (CSV) Internal Format

Text files consist of header and data portions.

The header includes the following information related to measurement data.

- (1) File name and version, (2) Title comment, (3) Start trigger time,
- (4) Channel setting row content, (5) Channel setting rows, (6) Data row content, (7) Data rows

```

"File name","WAVE0001.CSV","V 1.00" *****(1)
"Title comment"," *****(2)
"Trigger Time","12-07-01 09:14:03" *****(3)
"Ch","Mode","Range","Comment","Scaling","Ratio","Offset" *****(4)
"CH-1","Voltage","100mV","Off"," "," "
"CH-2","Voltage","1V","Off"," "," "
"CH-3","Voltage","10V","Off"," "," "
"CH-4","Voltage","20V","Off"," "," "
"CH-5","Voltage","100V","Off"," "," "
"CH-6","Voltage","1.5V","Off"," "," "
"CH-7","Tc","2000 C","Off"," "," "
"CH-8","Tc","2000 C","Off"," "," "
"CH-9","Tc","2000 C","Off"," "," "
"CH-10","Tc","2000 C","Off"," "," "
"P-1","Count","100000000c","Off"," "," "
"P-2","Count","100000000c","Off"," "," "
"P-3","Revolve","5000r/s","Off"," "," "
"P-4","Revolve","5000r/s","Off"," "," "
"ALM","Alarm"," "
"Time","CH-1[V]","CH-2[V]","CH-3[V]","CH-4[V]","CH-5[V]","CH-6[V]","CH-7[C]","CH-8[C]","CH-
9[C]","CH-10[C]","P-1[c]","P-2[c]","P-3[r/s]","P-4[r/s]","ALM-CH1","ALM-CH2","ALM-CH3","ALM-
CH4","ALM-CH5","ALM-CH6","ALM-CH7","ALM-CH8","ALM-CH9","ALM-CH10","ALM-
PLS1","ALM-PLS2","ALM-PLS3","ALM-PLS4","ALM-OUT","Event" ***** (6)
0.00000000E+00,-1.30000E-04,-5.05000E-03,-5.50000E-02,-1.10000E-01,-5.45000E-01,-
5.50000E-02,3.59000E+01,3.33000E+01,3.17000E+01,3.60000E+01,0.00000000E+00,
0.00000000E+00,0.00000000E+00,0.00000000E+00,0.00000000E+00,0.00000000E+00,
1.000000000E+00,-2.15000E-04,-5.25000E-03,-5.55000E-02,-1.10000E-01,-5.45000E-01,-
5.50000E-02,2.62000E+01,2.36000E+01,2.28000E+01,2.97000E+01,0.00000000E+00,
0.00000000E+00,0.00000000E+00,0.00000000E+00,0.00000000E+00,0.00000000E+00,
2.00000000E+00,1.06000E-03,-4.60000E-03,-5.50000E-02,-1.10000E-01,-5.45000E-01,-
5.35000E-02,1.73000E+01,3.06000E+01,2.99000E+01,3.25000E+01,0.00000000E+00,
0.00000000E+00,0.00000000E+00,0.00000000E+00,1.00000000E+00,1.00000000E+00,
3.00000000E+00,-2.30000E-04,-3.55000E-03,-5.50000E-02,-1.09000E-01,-5.45000E-01,-
5.45000E-02,5.06000E+01,4.49000E+01,4.11000E+01,5.32000E+01,0.00000000E+00,
0.00000000E+00,0.00000000E+00,0.00000000E+00,0.00000000E+00,0.00000000E+00,
4.00000000E+00,-8.50000E-05,-5.05000E-03,-5.55000E-02,-1.10000E-01,-5.45000E-01,-
5.50000E-02,3.49000E+01,3.28000E+01,3.17000E+01,3.56000E+01,0.00000000E+00,
0.00000000E+00,0.00000000E+00,0.00000000E+00,0.00000000E+00,0.00000000E+00,
5.50000000E+00,-6.35000E-04,-5.45000E-03,-5.65000E-02,-1.10000E-01,-5.45000E-01,-
5.50000E-02,2.04000E+01,1.89000E+01,2.49000E+01,2.66000E+01,0.00000000E+00,
0.00000000E+00,0.00000000E+00,0.00000000E+00,0.00000000E+00,0.00000000E+00,
6.60000000E+00,-1.10500E-03,-5.25000E-03,-5.55000E-02,-1.10000E-01,-5.45000E-01,-
5.50000E-02,2.29000E+01,2.27000E+01,2.46000E+01,2.19000E+01,0.00000000E+00,
0.00000000E+00,0.00000000E+00,0.00000000E+00,0.00000000E+00,0.00000000E+00,
7.00000000E+00,5.85000E-04,-5.10000E-03,-5.55000E-02,-1.10000E-01,-5.45000E-01,-
5.60000E-02,2.73000E+01,2.53000E+01,2.45000E+01,2.31000E+01,0.00000000E+00,
0.00000000E+00,0.00000000E+00,0.00000000E+00,1.00000000E+00,0.00000000E+00,
8.00000000E+00,1.08000E-03,-4.45000E-03,-5.50000E-02,-1.09000E-01,-5.45000E-01,-
5.50000E-02,5.21000E+01,4.28000E+01,3.89000E+01,6.01000E+01,0.00000000E+00,
0.00000000E+00,0.00000000E+00,0.00000000E+00,1.00000000E+00,1.00000000E+00,
9.00000000E+00,-2.45000E-03,-5.85000E-03,-5.60000E-02,-1.10000E-01,-5.50000E-01,-
5.60000E-02,2.33000E+01,2.37000E+01,2.48000E+01,2.64000E+01,0.00000000E+00,
0.00000000E+00,0.00000000E+00,0.00000000E+00,0.00000000E+00,0.00000000E+00,
1.00000000E+01,1.05000E-04,-6.35000E-03,-5.65000E-02,-1.11000E-01,-5.50000E-01,-
5.65000E-02,1.06000E+01,1.39000E+01,1.58000E+01,1.28000E+01,0.00000000E+00,
0.00000000E+00,0.00000000E+00,0.00000000E+00,1.00000000E+00,0.00000000E+00,

```

Appendix 4 Binary File Size Calculation

(Byte units)

File size = Header size + Data size

Header size = Text header size + Binary header size

Text header size = $512 \times (4 + \text{no. of analog channels} \times 2 + \text{no. of pulse channels} \times 2 + \text{no. of alarm channels} \times 28)$

Binary header size = $512 \times (5 + \text{no. of analog channels} + \text{no. of pulse channels} + \text{no. of alarm channels})$

Data size = $\text{no. of analog channels} \times 2 + \text{no. of pulse channels} \times 4 + \text{no. of alarm channels} \times 2$

You can check an estimate of the remaining time available on the attached CF card/ USB flash drive on the **[Setting]** screen.

(About 90% of the time calculated using the above formulas is displayed as the **[Available save time]** on the **[Setting]** screen, reflecting the fact that file and other information apart from actual data is also stored on the media.)

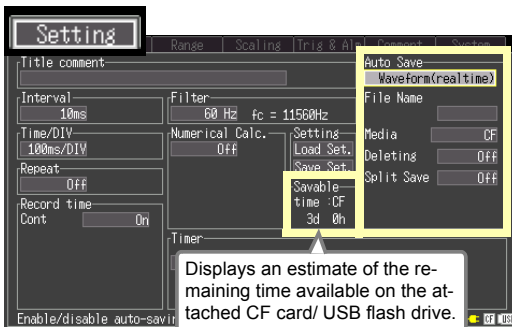

Appendix 5 List of Default Settings

When shipped from the factory or initialized to factory defaults, the settings are as follows.

Screen	Setting Item	Default Setting
Setting	Interval	10ms
	Filter	60 Hz
	Time/DIV	100ms/div
	Cont	On
	Repeat	Off
	Numerical Calc.	Off
	Calc1	Off
	Calc2	Off
	Calc3	Off
	Calc4	Off
	Timer	Off
	Auto Save	Off
	CH	On/Off
Input		CH1 to 10: Voltage, P1 to 4: Count
Range		100mV
Thermo couple		K
Burn Out		Off
RJC		Int
Count Mode		Add
Pulse/Rev		1
Slope		↑
Disp Span		Position
Zoom		Voltage and Revolve: x1, Tc: x20
0 pos		Voltage: 50%, Tc and Revolve: 0%
Upper		Voltage: 0.05, Temperature: 100, Count and Revolve: 5000
Lower		Voltage: -0.05, Tc, Count and Revolve: 0
Scaling		Off
Start Trig.		Off
Stop Trig.		Off
Alarm	Off	

Screen	Setting Item	Default Setting
Trig& Alm	Trig Func	Off
	Timing	Start
	Trig Source	
	Start	OR
	Stop	OR
	Ext Trig	
	Start	Off
	Stop	Off
	Pre-Trig	0d 0h 0m 0s
	Alarm	Off
	Source	OR
System	Start Backup	Off
	Backlight Saver	Off
	Backlight Brightness	100%
	Display Color	Black
	Beep Sound	On
	External Trig In	Trigger
	Time Disp	Time
	Language	English
	SAVE Key Operation	Select & Save
	Decimal Mark	Dot
	Separator	Comma
	USB memory mode	USB Memory

Appendix 6 Maximum Recordable Time

When saving waveform files in the form of binary data to either the instrument's internal memory or the CF card or USB flash drive, maximum recording times are as follows.

The indicated times apply when recording all channels. Maximum recording time is inversely proportional to the number of recording channels.

Because the header portion of waveform files is not included in these calculations, actual times should be expected to be about 90% of the listed values.

Day values beyond 365 are not shown in the table.

When saving data in text format (CSV), the maximum recording time is reduced to 1/10 of the value indicated in the table or less.

(d: days/ h: hours/ min: minutes/ s: seconds)

Interval	Recording capacity				
	LR8431-20 internal memory (7MB)	9727 (256MB)	9728 (512MB)	9729 (1GB)	9830 (2GB)
10ms	32min	19h 37min	1d 15h 14min	3d 6h 29min	6d 12h 58min
20ms	1h 4min	1d 15h 14min	3d 6h 29min	6d 12h 58min	13d 1h 57min
50ms	2h 40min	4d 2h 6min	8d 4h 13min	16d 8h 26min	32d 16h 53min
100ms	5h 21min	8d 4h 13min	16d 8h 26min	32d 16h 53min	65d 9h 47min
200ms	10h 43min	16d 8h 26min	32d 16h 53min	65d 9h 47min	130d 19h 35min
500ms	1d 2h 49min	40d 21h 7min	81d 18h 14min	163d 12h 29min	327d 59min
1s	2d 5h 39min	81d 18h 14min	163d 12h 29min	327d 59min	–
2s	4d 11h 18min	163d 12h 29min	327d 59min	–	–
5s	11d 4h 16min	–	–	–	–
10s	22d 8h 33min	–	–	–	–
20s	44d 17h 6min	–	–	–	–
30s	67d 1h 39min	–	–	–	–
1min	134d 3h 18min	–	–	–	–
2min	268d 6h 36min	–	–	–	–
5min or more	–	–	–	–	–

$$\text{Maximum Recordable Time} = \frac{\text{Recording capacity}^{*1} \times \text{Recording interval (s)}}{\text{No. of recording channels}^{*2} \times 2}$$

*1. Recording capacity: 7 x 1024 x 1024 (for internal memory)

*2. No. of recording channels = (no. of analog channels) + (no. of pulse channels x 2) + (alarm channel)

Appendix 7 Reference

LR8431-20 Measurement Values

Model LR8431-20	16 bits				
	0	1	8000	FFFE	FFFF
100 mV	-OVER	-163.835 mV	0.000 mV	163.830 mV	OVER
1 V	-OVER	-1.63835 V	0.00000 V	1.63830 V	OVER
10 V	-OVER	-16.3835 V	0.0000 V	16.3830 V	OVER
20 V	-OVER	-32.7670 V	0.0000 V	32.7660 V	OVER
100 V	-OVER	-163.835 V	0.0000 V	163.830 V	OVER
Thermocouple	-OVER	-3276.7°C	0.0°C	3276.6°C	OVER

Model LR8431-20	32 bits			
	0	1	3FFFFFFE	3FFFFFFF
Integration	0 c	1 c	1073741822 c	OVER
Revolution	0 r/s	1 r/s	1073741822 r/s	OVER

Appendix 8 Concerning Noise Countermeasures

Mechanism of Noise Introduction into Thermocouple Temperature Measurements

What are the sources of noise?

Within a factory, power is provided by large current flows at 50/60Hz. The main loads are primarily L loads, such as motors and solenoids; in addition, large current pulses are produced by capacitor input-type switching power supplies for device such as inverters and high-frequency induction furnaces. Basic wave component leak current, harmonic wave current, and other types of noise become mixed into the flow from each ground point to ground lines.

What are the paths of noise propagation?

- Common mode voltage introduced between the ground points of the device being tested and the instrument leaks to the input signal lines
- AC magnetic fields produced by current in power lines couple into loops in the input signal lines
- Coupling due to electrostatic capacitance between input signal lines and power supply lines

What is common mode noise?

Noise that is generated between ground and the "+" and "-" input terminals of the instrument.

What is normal mode noise?

Inter-line noise that is generated between the "+" and "-" input terminals of the instrument.

Example of Connections Where Noise Can Affect Measurements

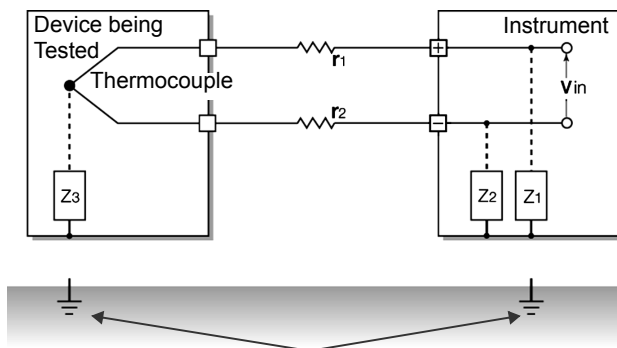

When using a thermocouple to measure temperature, noise can affect measurements unless both the device being tested and the instrument are grounded. Although there is no problem if the instrument is running on battery power, the instrument must be connected to ground if an AC adapter is being used.

Equivalent Circuit of Noise Introduction Path

Measurements are directly affected by normal mode voltages from electromagnetically induced noise resulting from electromagnetic coupling into looped instrument input lines by AC magnetic fields produced by inverters and commercial power lines, as well as the capacitive coupling that results from interline capacitance.

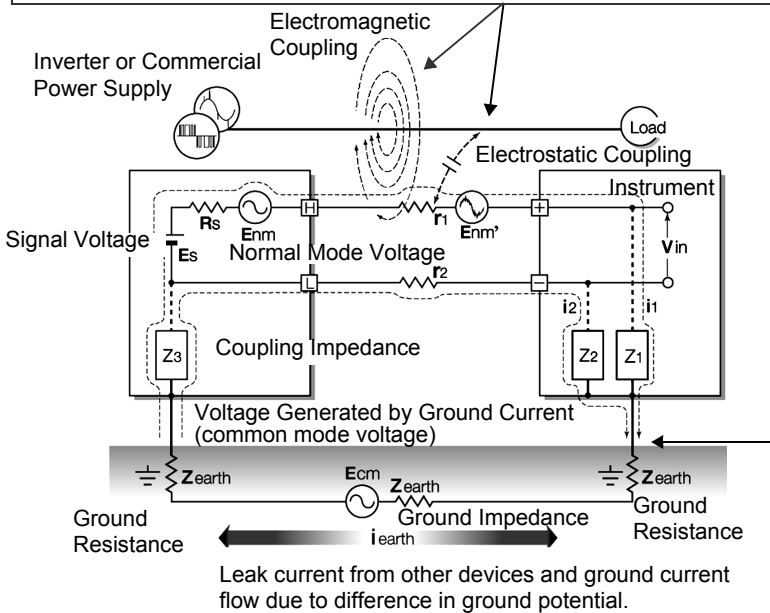

Common mode noise results from the interposition of ground impedance between the ground point of the device being tested and the ground point of the instrument, and from capacitor coupling between the ground wire and noise source. Common mode noise is converted to normal mode voltage (E_{nm}) that is added to the "+" and "-" input terminals of the instrument as a result of the noise current (i_1) and (i_2) that flows to the coupling impedance (Z_1) and (Z_2) between the "+" and "-" input terminals of the instrument and ground. Because common mode noise is generated between the input pins, it has a direct effect on the measurements.

The Importance of Device Grounding

Ground the instruments (Model LR8431-20) securely

The LR8431-20 is designed so that the chassis is grounded when the three-prong power cord from the adapter is plugged directly into a grounded, three-prong receptacle.

If a three-prong-to-two-prong adapter must be used on the AC adapter power cord and therefore the instrument is not grounded, the instrument can still be grounded by connecting a grounded wire to the GND terminal (a pushbutton terminal) located on the side of the LR8431-20.

Securely ground the chassis of the device being tested.

Securely connect the chassis of the device being tested to a good ground.

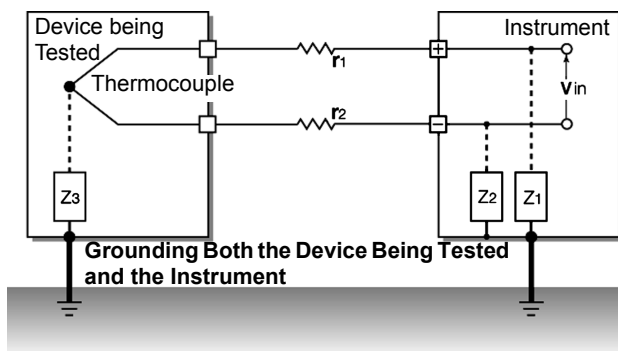

Connecting the chassis GND on the signal side to the instrument chassis

When connecting the chassis ground of the LR8431-20 to the chassis ground of the device being tested and then to ground, use a wire that is as short and as thick as possible to bring both pieces of device to equal potential.

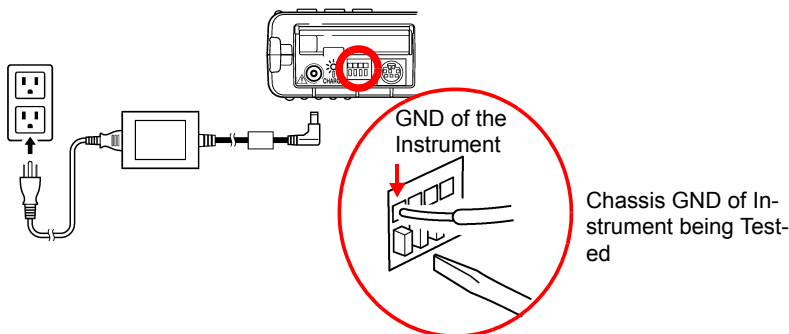

Running the instrument (Model LR8431-20) on battery power

When the instrument is being powered by batteries and the AC adapter is not connected, the ground current loop is eliminated, making it possible to reduce the effects of common mode noise.

For measurements of short duration, powering the LR8431-20 with batteries is an effective method for eliminating noise.

Common Mode Noise Countermeasures

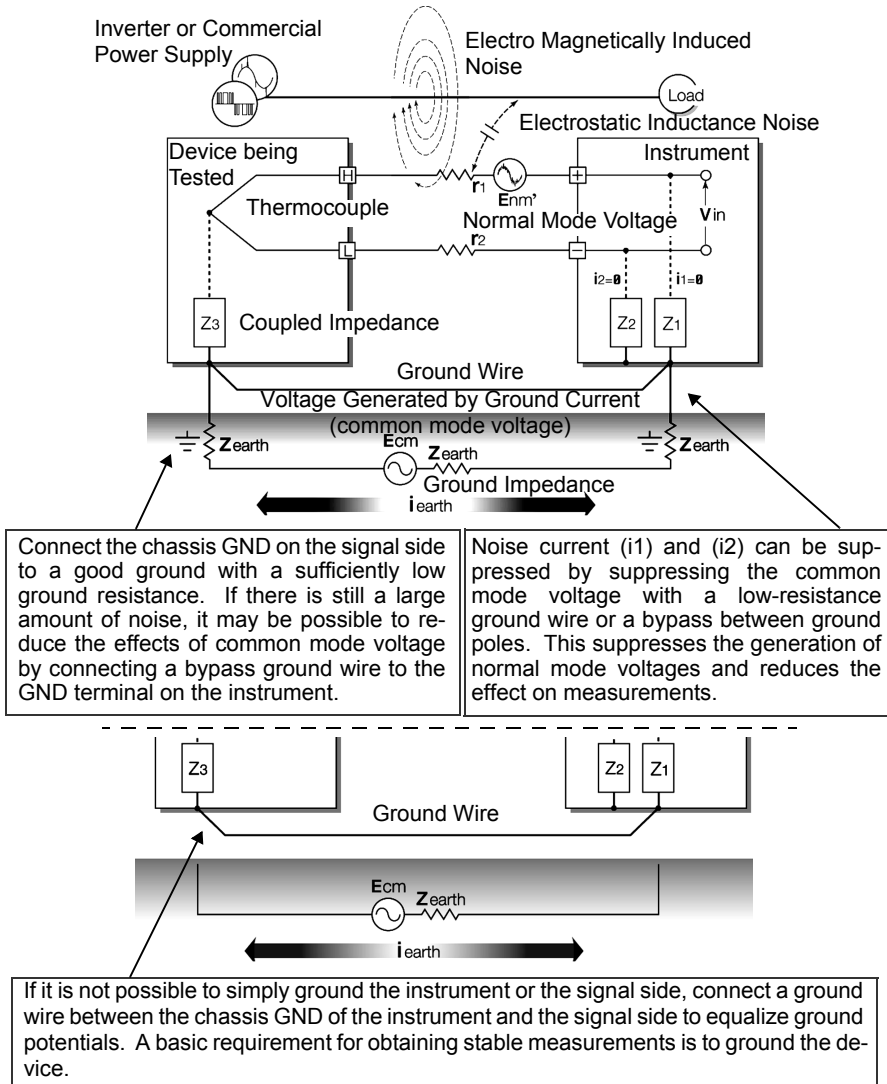

Blocking Noise from External Sources

Keep signal lines away from noise sources

Keep input signal lines (of the thermocouple) away from wiring that is a noise source (such as power lines, etc.), and make any permanent installation with as much separation as possible; for example, by running wires through a separate duct.

Use shielded twisted pair wiring

It is effective to use shielded twisted pairs for the input signal lines (of the thermocouple). Twisted pairs are effective for preventing electromagnetic induction, and shielded wires are effective for preventing electrostatic induction.

The shielded wires should basically be grounded on the signal source side. If it is not possible to connect the signal source to ground, connect it to the chassis GND on the LR8431-20. Note that doing so has no effect if the LR8431-20 is not itself connected to ground through the three-prong power cord, etc.

Shielded twisted pair wires for the thermocouple can be obtained from thermocouple manufacturers.

Normal Mode Noise Countermeasures

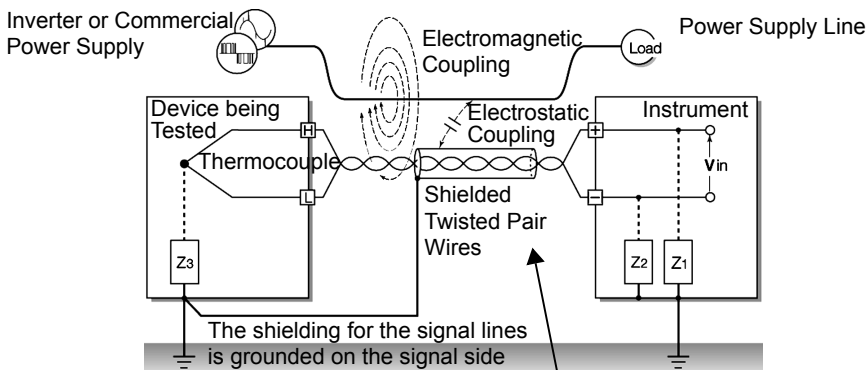

Keep the signal lines (of the thermocouple) away from wiring that is a noise source (such as power lines, etc.). It is also possible to shield the signal lines from electrostatic coupling and to block noise by grounding the shield.

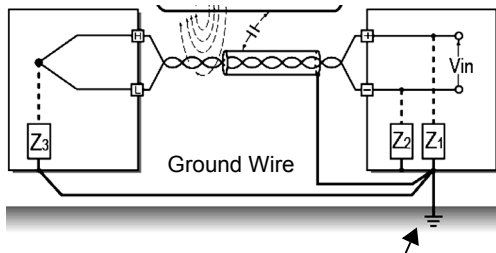

If the signal side is not grounded or if it is grounded inadequately, connect the instrument to ground. Also ground the shielding for the signal wires on the instrument side securely.

Insulation from noise sources (temperature measurement by thermocouple)

The analog input channels are insulated from the chassis and each other. Therefore, the instrument allows you to attach the thermocouple directly to a conductor with a potential to measure it, provided that the voltage to ground does not exceed the maximum rating. If noise is likely to affect measurement, wrap heat-resistant tape around the thermocouple for insulation, or use an ungrounded thermocouple and electrically insulate the input line.

Setting the Digital Filter

To remove noise from input signals, the digital filter can be set for the analog channels.

The longer the recording interval is, the larger the noise reduction effect becomes; this ensures highly accurate measurement with little scatter.

See: For recording interval and cutoff frequency (p.141)

For example, assuming that the digital filter is set to 60Hz, noise reduction in the supply frequency is maximized at a recording interval from 2 sec. to 1 hr.

Inserting a Capacitor in the Signal Line

When noise affects the signal source directly or when measuring high-frequency pulses, it is effective to insert a capacitor between the "+" and "-" input terminals so that the noise does not enter the LR8431-20. When inserting a capacitor, use one with a rated voltage that is equal to or exceeds the input voltage.

When a capacitor is inserted between the "+" and "-" input terminals, there are no restrictions on the recording interval because the filter is applied before the channel scan operation.

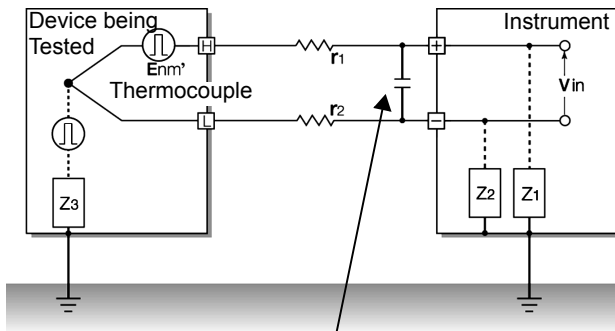

The capacitance of the capacitor should range from several μF to several thousand μF . Insert the capacitor between the "+" and "-" input terminals.

Appendix 9 Using the Application Program

The following features are available when using the supplied computer application program.

Display on the computer screen waveform files that were saved to CF card or USB flash drive on the Memory HiLogger. Convert binary data to CSV format for importing to spreadsheet programs on the computer.

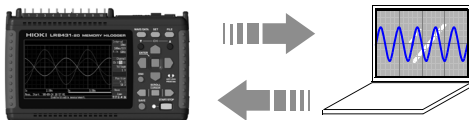

Configure Memory HiLogger settings on the computer, and transfer to the Memory HiLogger.

Search event marks and measurement data using various criteria such as maxima and fluctuation values.

Acquire batch measurement data in real time from up to five HiLoggers on one computer using USB connections. Monitor waveforms, numerical values and alarm output status in real time while measuring.

The Logger Utility application program needs to be installed on the computer before use. A USB driver also needs to be installed on the computer to enable communications with the Memory HiLogger. The application program can be installed from the supplied CD, or you can download the latest version from the Hioki web site.

Use the following procedure to install the software on the computer. Verify operating environment compatibility before installing. For details such as application program operating instructions, read the instruction manual (PDF file) provided on the CD.

Operating Environment

- OS: Windows XP (32-bit)
Windows Vista® (32-bit/64-bit)
Windows 7 (32-bit/64-bit)
Windows 8 (32-bit/64-bit)
Windows 10 (32-bit/64-bit)
- CPU: 1 GHz or faster x86 or 64-bit processor
- Monitor Resolution: 1024 x 768 dots or better 65536 colors or more
- Memory: 1 GB or more RAM (32-bit), 2 GB or more RAM (64-bit)
- Interface: USB
- Hard disk: 3.0 GB or more of available space

- 1** Set the CD into the drive of the computer.
- 2** Install Logger Utility (p. A20).
- 3** Install the USB driver (p. A23).
- 4** Connect the AC adapter to the instrument and turn on the power.
- 5** Set the USB mode to [USB Communication] on the [System] screen.
- 6** Connect the instrument and computer with the USB cable (p. A26).

NOTE

Because the USB mode on the [System] screen must be set to [USB Communication], it is not possible to record data to or load data from a USB flash drive while using the Logger Utility application software. The [USB Memory], [USB Communication], and [USB Drive] USB mode settings are exclusive and cannot be used simultaneously.

Installing Logger Utility

Follow the procedure below to install Logger Utility. This explanation is for installing the software on Windows XP. The messages displayed may differ slightly depending on other operation system or settings you are using.

Important

If you are running software such as antivirus software, be sure to end the software before you start the installation. The installation may not be performed properly if antivirus software is running.

1 Start up Windows® .

Exit all running applications.

2 Insert the included CD into the computer's CD-ROM drive, the installer run automatically.

If the installer do not start, execute "setup.exe" from the CD-ROM drive.

If the installer do not start, execute "setup.exe" from the CD-ROM drive.

In Windows Vista®/Windows 7/Windows 8/Windows 10, Although the dialog which ask for installation permission of application, click [Allow].

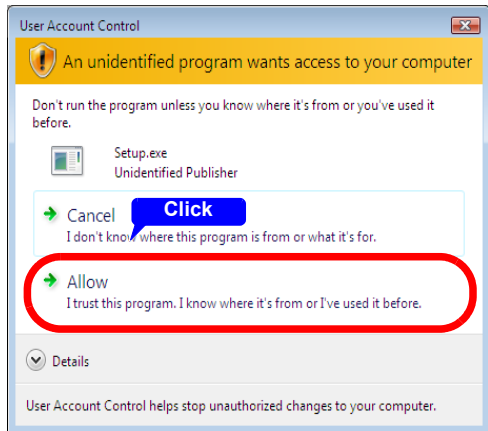

- 3 In the installer, click **[Next]** and confirm the installation destination.

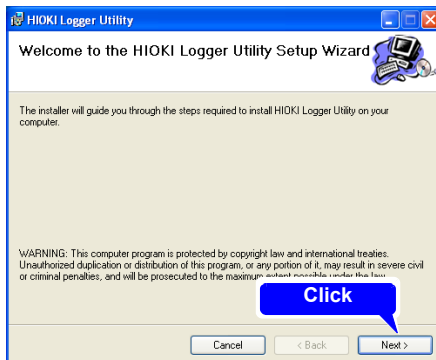

The end user license agreement is displayed. Read the EULA, then select **[Agree]**, and click **[Next]**.



The installation destination folder can be changed on this screen.

If you are not changing the installation destination, click **[Next]**.

To change the installation destination, click **[Browse]** to select another folder.

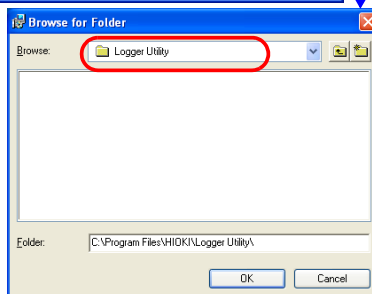
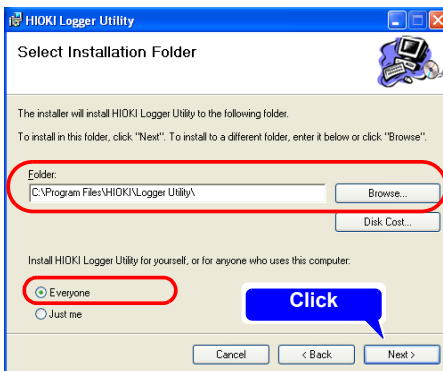

Appendix 9 Using the Application Program

4 Click **[Next]** to start installing.

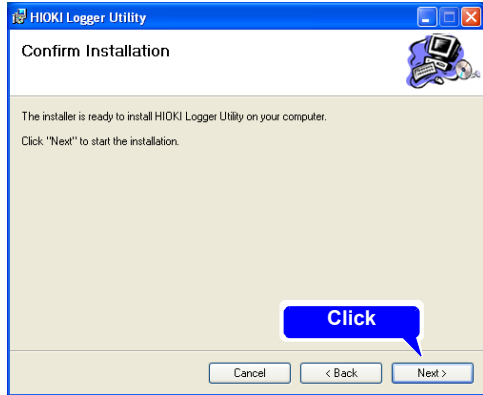

Installation starts.

Progress is displayed during installation.

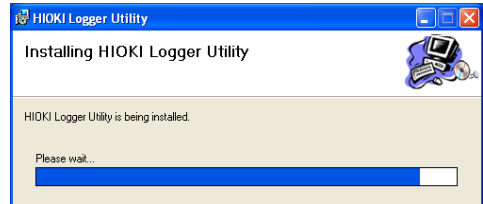

To interrupt installation in progress, click **[Cancel]**.

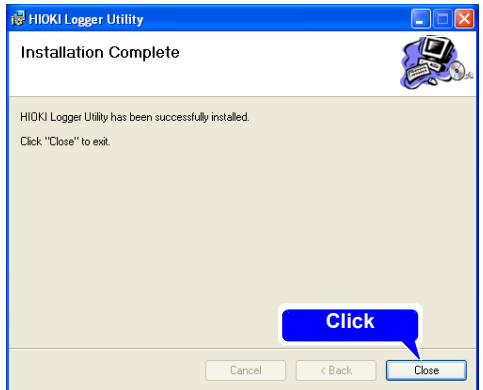

Installation finished

Installing the USB Driver

Install the USB driver before you use the instrument with a USB connection.

1 (Insert the CD found in the package into the CD-ROM drive.)

Install the driver.

- Run [SetupDriver32.msi] in the CD.
If [Logger Utility] is already installed, run the CD from the following location.
[c:\Program Files\HIOKI\LoggerUtility\Driver\SetupDriver32.msi]

If you are using the Windows Vista® /Windows 7/Windows 8/Windows 10 64bit version:

- Run [SetupDriver64.msi] in the CD.
If [Logger Utility] is already installed, run the CD from the following location.
[c:\Program Files(x86)\HIOKI\LoggerUtility\Driver\SetupDriver64.msi]

Depending on the environment, the dialog box may take some time to appear so please wait till it does so.

2 Click [Next].



3 Check [Next].

When you want to change the installation destination, click [Browse...] to change the folder to install into. To change, there is no need to change.

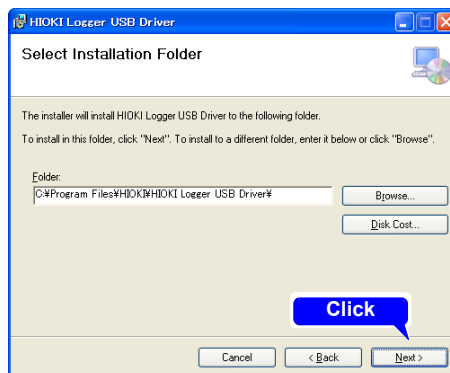

4 Click [Next].

Start installing.

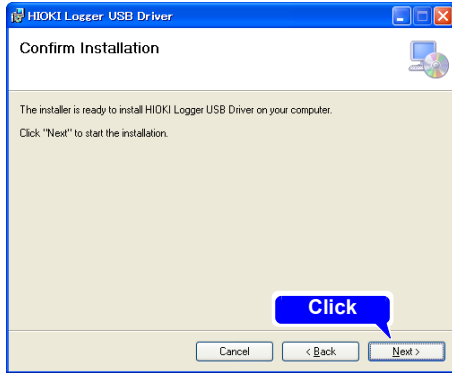

Installing.



For Windows XP

During the installation, a message saying that the software has not passed Windows® Logo testing will appear a few times, click [Continue Anyway] to continue installing.



For Windows Vista®/Windows 7/Windows 8/Windows 10

When a dialog box requesting your permission to continue the program appears, click [Continue].

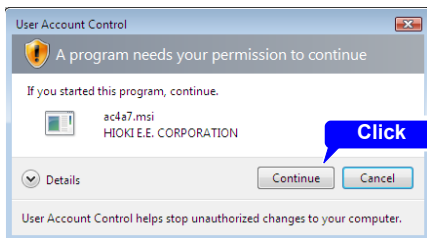

Sometimes another dialog box requesting your permission to install the software may appear. When it does, check “Always trust software from “HIOKI E.E. CORPORATION” and click [Install] to continue.

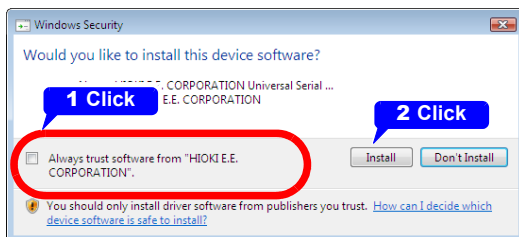

- 5** When installation is completed and the dialog box appears, click [Close] to exit.

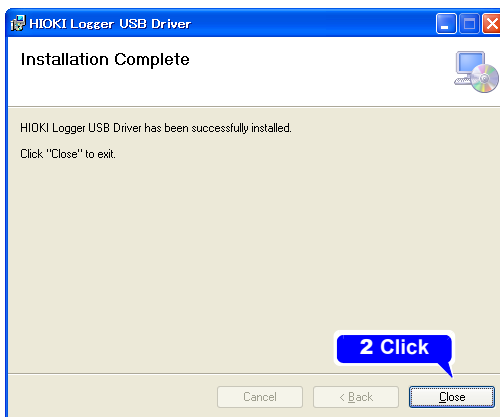

This completes the driver installation.

Connecting the Memory HiLogger to the Computer with a USB Cable

Install the USB driver before you use the instrument with a USB connection. (p. A23)



CAUTION

- Do not pull out the USB cable during data transfer. Doing so would prevent proper data transfer.
- The Memory HiLogger and computer should be connected to the same earth ground. If grounded separately, potential difference between the ground points can cause malfunctions or damage when connecting the USB cable.

Set the USB mode on the [System] screen to [USB Communication] before connecting the USB cable to the instrument. Connecting the USB cable without enabling USB Communication mode will prevent the instrument from being able to communicate with the Logger Utility.



- 1** Orient the USB cable plug properly, and insert it into the receptacle.

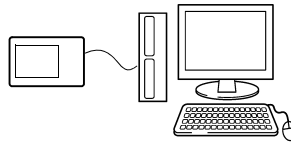

- 2** Connect the AC adapter to the instrument and turn on the power.
- 3** Connect the other end of the cable to a USB port on the computer.



Connecting with the HiLogger the first time

For Windows Vista®/Windows 7/Windows 8/Windows 10

The HiLogger will be recognized automatically and the device will be ready to use.

For Windows XP

A “[Found New Hardware Wizard](#)” dialog box will appear and the new hardware de-

The HiLogger is already recognized

Start the Logger Utility (p. A29)

Windows XP

1 Connect the instrument and computer with the USB cable.
After the "Found New Hardware" window appears, the [Found New Hardware Wizard] dialog box will appear.

2 Check "No, not this time" and click [Next].

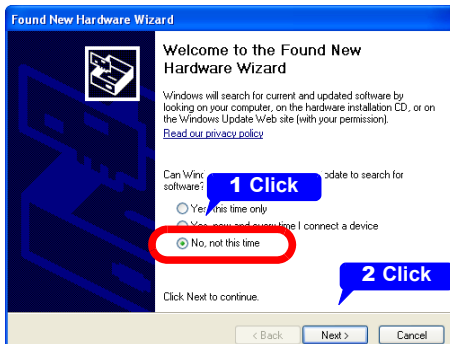

3 Check "Install the software automatically (Recommended)" and click [Next].

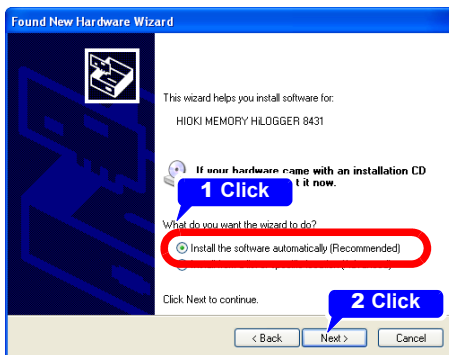

Please wait while the driver is being installed.

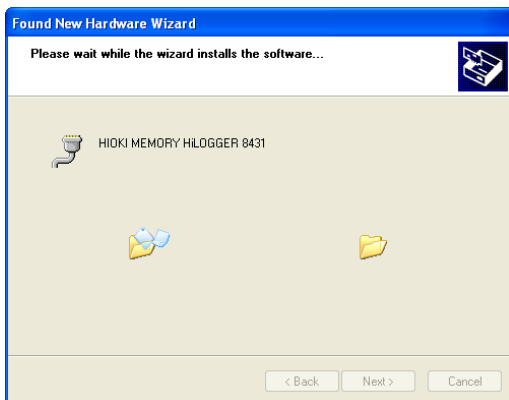

Appendix 9 Using the Application Program

4 A message saying that the software has not passed Windows Logo testing will appear a few times, click [\[Continue Anyway\]](#) to continue installing.



5 When installation is complete, the next dialog will appear. Click [\[Finish\]](#).

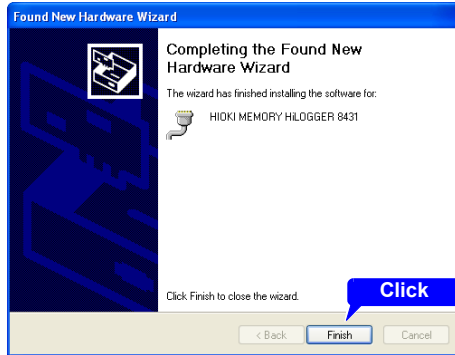

This completes the driver installation.

Starting and Ending Logger Utility

Starting Logger Utility

From the Start Menu of Windows®, click [All Programs] - [HIOKI] - [Logger Utility] - [Logger Utility].

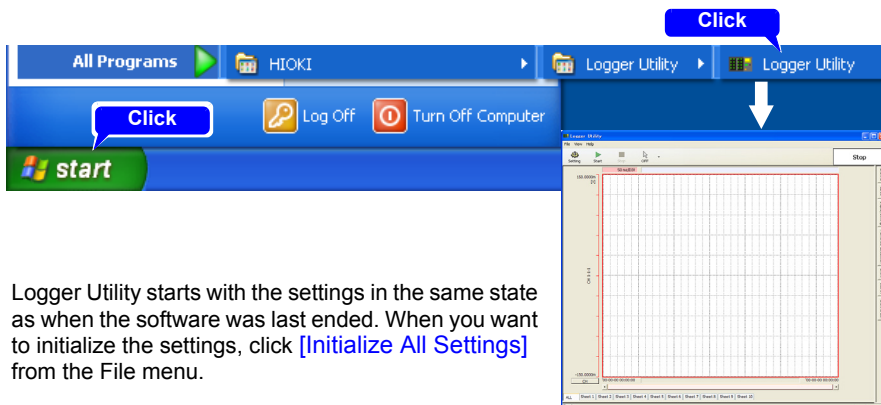

Logger Utility starts with the settings in the same state as when the software was last ended. When you want to initialize the settings, click [Initialize All Settings] from the File menu.

Ending Logger Utility

Click [Exit Application] from the File menu of the main screen. Alternatively, you can click the [x] close button at the top right of the main screen.

Uninstalling the Logger Utility

Use the following procedure to uninstall the program.

- 1 From the Windows® Start menu, select the [Control Panel], and double click [Add or Remove Programs].



The [Add or Remove Programs] screen appears.

- 2 From the list of installed programs, select [Logger Utility], and remove it. You are returned to the [Add or Remove Programs] screen. Settings files are not deleted during uninstall, so if no longer needed, delete them manually.

Appendix 10 Frequently Asked Questions

Here are some common questions and answers about the HiLogger.

Installation and Settings

Question	Remedial Action	Reference page
How to measure the temperature of an object having applied voltage?	The instrument provides this functionality. Since the maximum channel-to-channel and channel-to-ground voltage is 30 Vrms AC or 60 V DC, exercise caution not to exceed those levels. When exceeding them, take steps to prevent the voltage from being applied to the instrument, for example by using an ungrounded thermocouple.	Precautions in 2.3, "Connecting Measurement Cables to the Memory HiLogger" (p.31)
What is the maximum measuring time using the battery pack?	The maximum measuring time is about 2.5 hours (25°C reference value when saving data to a CF card). When using a USB flash drive, note that the amount of time that measurement can be performed with the battery pack may be shortened depending on the USB flash drive being used.	2.1, "Using the Battery Pack (Option)" (p.26)
What is the power consumption?	Normal consumption is about 3.5 VA, and maximum (while charging the battery with maximum LCD brightness) is 10 VA.	"Maximum rated power" (p.138)

Question	Remedial Action	Reference page
Can recording resume automatically after a power outage?	<p>Enable Auto Resume. Recording will automatically resume after a power outage.</p> <p>Because data measured before the outage is not retained in internal memory, we recommend enabling auto saving to removable storage. However, if the power goes out during real-time save operation, the data on the CF card may be corrupted. It is recommended to back up the power supply with the battery pack. However, data on the CF card may still be corrupted if the battery pack power supply fails during an extended power outage.</p> <p>High-end LR8400 series instruments use a built-in, high-capacity capacitor to perform file termination processing in the event of a power outage, allowing them to save data up to the time of the outage.</p>	"Using the Auto-Resume Function (Resume After Power Restoration)" (p.120)
If battery power fails while the instrument is being powered by the battery, will recording resume when AC power is restored?	<p>When battery power fails while the instrument is being powered by the battery, the instrument will not turn back on until the power switch is cycled from OFF to ON. A high-end LR8400 series instrument is recommended for applications requiring this type of operation.</p>	2.1, "Using the Battery Pack (Option)" (p.26)
How to minimize thermocouple measurement error when moving the HiLogger between places with much different temperatures?	<p>For thermocouple measurements, terminal temperature is measured by an internal sensor to provide reference junction compensation. When the ambient temperature changes abruptly, or when air blows directly on the terminals, errors occur due to thermal imbalance between the terminals and temperature sensor.</p> <p>When the HiLogger is moved to a location with significantly different ambient temperature, allow at least 30 minutes for thermal equalization before measuring.</p>	"Instrument Installation" (p.6)

Appendix 10 Frequently Asked Questions

Question	Remedial Action	Reference page
When connecting a thermocouple directly to the HiLogger, should reference junction compensation be set to external (EXT) or internal (INT)? How is accuracy affected?	Select INT when connecting a thermocouple (or compensating leads) directly to the HiLogger. Overall measurement accuracy is the sum of the accuracies of the thermocouple and the reference junction compensation (RJC). Example: When measuring a temperature from -100°C to 1,300°C with a K thermocouple The measurement accuracy is $\pm 1.5^\circ\text{C}$, obtained by adding the reference junction compensation accuracy of $\pm 0.5^\circ\text{C}$ to the temperature measurement accuracy of $\pm 1.0^\circ\text{C}$.	"Temperature Measurement Settings" (p.51)
How to display only CH1 to CH3?	Select only the channels to be used on the Input Channel Settings display. To acquire data without displaying it, select \times as the waveform display color.	3.4, "Setting Configuration 2 – Input Channel Settings" (p.49) "Selecting Waveform Display Color" (p.56)
I am measuring humidity with a converter that converts 0 to 100% RH to 1 to 5 V. How can I read humidity directly?	Set the scaling method to [2-pt], and enter the values. (1:1 conversion \rightarrow 0, 2:5 conversion \rightarrow 100, units: %RH)	"Converting Units (Scaling function)" (p.58)

Triggering

Question	Remedial Action	Reference page
Why does measurement not start when "Waiting for trigger" is displayed?	Triggering is enabled. To start recording immediately with the START key, disable all trigger criteria or the trigger function on the [Trig & Alm] screen.	4.3, "Confirming Trigger and Alarm Criteria Settings (List)" (p.75)
How to acquire data before a trigger?	Enable pre-triggering to acquire data before trigger events.	"Setting Criteria for Pre-Trigger Recording (Pre-Trig)" (p.72)

Appendix 10 Frequently Asked Questions

Question	Remedial Action	Reference page
How can I acquire data continuously starting on 1/4/2012, daily from 9:00 to 17:00, for one month?	Set as follows: Measurement Criteria [Interval]-[Cont]: Off, 8 hr 0 min 0 s [Repeat]: On Timer [Start]: On, 12 Year, 4 Mon, 1 Day, 9 Hour 0 Min 0 Sec [Stop]: On, 12 Year, 5 Mon, 1 Day, 9 Hour 0 Min 0 Sec [Interval]: On, 1 Day, 0 Hour 0 Min 0 Sec	3.3, "Setting Configuration 1 – Recording Settings" (p.42) 4.4, "Starting and Stopping Recording by Timer" (p.76)
Is it possible to measure on 20 channels using two synchronized HiLoggers?	Measurement start can be synchronized using an external trigger. Sampling cannot be synchronized.	9.5, "Synchronous Measurements with Multiple Instruments" (p.135)

Measuring

Question	Remedial Action	Reference page
What should I do about zero offset when the input is shorted?	Execute zero adjustment to compensate for offset when the inputs are shorted.	2.5, "Zero Adjustment" (p.35)
Even though a signal is only input on CH1, why do similar waveforms appear on unused channels?	An open-circuit input terminal can be affected by signals on other channels. By closing the input terminal circuit, normal measurement is possible. If this is impractical, disable unused measurement channels, or short the + and - terminals together.	
How to display numerical data values?	Press WAVE/DATA repeatedly to cycle through the Waveform (only), Waveform + Numerical Values, and Numerical Values (only) displays. Numerical values can be displayed in a large font on the enlarged numerical display. Numerical values at specific locations can be displayed using A/B cursors.	1.4, "Screen Configurations" (p.18) "Displaying Cursor Values" (p.84) "Viewing Input Signals as Numerical Values" (p.87)
What happens to pulse integration when there are more than one million pulses?	The counter saturates at 1,073,741,823 counts. If you expect to exceed this count, we recommend measuring with the Integration Mode ([Count]) set to Instantaneous ([Inst]), and summing later with a spreadsheet program.	"Integration (Count) Measurement Settings" (p.53)

Appendix 10 Frequently Asked Questions

Question	Remedial Action	Reference page
What is the timing difference between CH1 and CH2?	When the [Filter] is Off, the time difference between data on neighboring channels is about 780 μ s, regardless of recording interval. When the [Filter] is enabled (50 or 60 Hz), the time difference increases with longer recording intervals.	
How can I apply markers while measuring for easy searching later? How can I search for alarm event locations?	Event marks can be applied by the following methods. <ul style="list-style-type: none"> • Press the on-screen [Make Mark] button. • Apply a signal to the EXT.TRIG terminal 	5.3, "Inserting Event Marks (Search Function)" (p.88)

Data Saving

Question	Remedial Action	Reference page
Can after-market CF cards be used?	Operation cannot be guaranteed. Please use a Hioki-specified card to avoid problems.	6.2, "Using a CF Card/USB flash drive" (p.93)
Can after-market USB flash drives be used?	They can be used, although for real-time saving, we recommend using a Hioki-specified CF card option for data protection. Operation can only be guaranteed for Hioki CF card options. Also, USB flash drive security features such as fingerprint authentication are not supported. Use a USB flash drive whose continuous current consumption does not exceed 300 mA (peak 500 mA). (The peak value is displayed as "Max Power" under the USB flash drive self-test on the [System] screen.)	6.2, "Using a CF Card/USB flash drive" (p.93)
Can removable media be replaced while measuring?	Yes. Put the cursor on the [EJECT] button at the lower right of the screen, press ENTER, and remove the media following the displayed message.	"Replacing Removable Storage During Real-Time Saving" (p.48)
How much recording space is available?	It depends on setting conditions (number of channels and recording interval). About 327 days of recording is possible using 10 analog channels at 1 s recording interval to 1 GB media.	"Appendix 6 Maximum Recordable Time" (p. A11)

Appendix 10 Frequently Asked Questions

Question	Remedial Action	Reference page
How can I process acquired data later with a spreadsheet program?	Auto-saved files recorded in [Waveform(realtime)] mode to removable storage can be quickly and conveniently converted to a text (CSV) file with the Utility Logger program, which can then be loaded into a spreadsheet program. Auto-saved files recorded in [CSV(realtime)] mode can be directly loaded into a spreadsheet program, but note that the data cannot be reloaded into the HiLogger.	"Automatic Saving" (p.97)
How can I load data from a CF card onto the PC when it has no CF card slot?	Data can be transferred to a PC using the supplied USB cable and the USB Drive mode.	6.6, "Transferring Data to a Computer (USB Drive Mode)" (p.110)
How can I create files every hour, from 0:00 (ideal split time)?	Set auto-saving [Split Save] to Periodic ([Ref Time]).	"Automatic Save"(p.47)
What is the file limit when auto saving to removable storage?	Depending on file size and CF card capacity, more than 1,000 files can be saved in one folder, although only 1,000 can be displayed on the file screen. As the number of files increases, the time required to start and stop measurement also increases, so we recommend storing no more than 1,000 files, if possible. (When saving, a folder named "HIOKI_LR8431" is created, and files with different data types are saved in subfolders within it.)	6.1, "About Saving and Loading Data" (p.91)
Is data retained in internal memory when I turn the power off after measuring? I did not use auto saving to removable storage.	If the instrument is turned off with a 9780 Battery Pack with remaining power connected or the Z1005 AC Adapter connected, waveform data will be backed up to the instrument's internal memory. For the LR8431-20 with a fully charged 9780 Battery Pack, the waveform backup time is 100 hours.	"Waveform backup time function" (p.145)

Appendix 10 Frequently Asked Questions

Question	Remedial Action	Reference page
<p>If the power goes out while measurement is in progress, is the integrity of data being saved in real time to the CF card guaranteed?</p>	<p>If the power goes out during real-time save operation, the data on the CF card may be corrupted. It is recommended to back up the power supply with the battery pack. However, data on the CF card may still be corrupted if the battery pack power supply fails during an extended power outage.</p> <p>High-end LR8400 series instruments use a built-in, high-capacity capacitor to perform file termination processing in the event of a power outage, allowing them to save data up to the time of the outage.</p>	<p>2.1, "Using the Battery Pack (Option)" (p.26)</p>
<p>Why is only part of the data saved when saving to removable storage after measuring?</p>	<p>When a save range has been set with the A and B cursors, only the selected range is saved. Only data remaining in the instrument's internal memory (the last 3.5 M of data) will be saved after measurement.</p> <p>To save data in excess of that 3.5 M of data, enable the auto save (real-time) setting prior to measurement.</p>	<p>"Specifying a Waveform Time Span" (p.86) "Automatic Saving" (p.97)</p>
<p>After starting measurement with real-time auto saving, can I still acquire data if I neglected to insert removable storage media until later?</p>	<p>As long as storage media is inserted before internal memory overflows, data from the start of measurement will be saved to the removable storage.</p> <p>The instrument's internal memory can become full in as little as 32 minutes. However, since it takes time to save unsaved data to a CF card or USB flash drive inserted during measurement, it is best to use one-third of that 32-minute figure, or about 10 minutes, as a rough estimate of the length of data that can be saved once measurement starts.</p>	<p>"Replacing Removable Storage During Real-Time Saving" (p.48)</p>
<p>Why does "Saving" continue to be displayed and saving not finish when saving internal memory data as text after measurement?</p>	<p>To save all data from a full internal memory to removable media as text after measurement takes about one hour.</p> <p>To abort the saving process, press and hold STOP for some time.</p> <p>We recommend saving binary data, and later converting to text with the Logger Utility (which takes only a few seconds).</p>	<p>"7.1.1 Saving Measurement Data as Text," Logger Utility instruction manual</p>

Question	Remedial Action	Reference page
How to view data saved in binary format on a PC?	The Logger Utility PC application program is included on the supplied CD. Install it on the PC and use it to open the file. Double-clicking on a binary-format MEM file will not cause the file to be opened if the file has not been associated with the Logger Utility. Instead of double-clicking the file, MEM files can be opened with the Logger Utility by dragging and dropping them onto the Logger Utility. (Similarly, they can be opened by using the "Open Waveform File" command on the "File" menu.)	"Appendix 9 Using the Application Program" (p. A19)
When opened in Excel®, the time displayed is elapsed time from start. How can I display real time?	When saving data in CSV format on the HiLogger, the displayed time is determined by the [Time Disp] setting on the System screen. Select [Date] to display real time. When converting CSV format with the Logger Utility, set the [Time Axis Format] to [Absolute Time].	"Selecting the Horizontal (Time) Axis Display" (p.122) "7.1.1 Saving Measurement Data as Text," Logger Utility instruction manual
What are the files with .MEM and .LUW extensions?	MEM is the file extension for HiLogger waveform data, and LUW is the file extension for Logger Utility waveform data. LUW files cannot be loaded into the HiLogger.	6.1, "About Saving and Loading Data" (p.91) Logger Utility instruction manual
How are event marks handled when converting data to text (CSV)?	When converting data to text with the HiLogger: Event numbers are included alongside measurement data. This is convenient when you need to later extract only marked data. When converting data to text with the Logger Utility: Event mark information is not included.	5.3, "Inserting Event Marks (Search Function)" (p.88)
Can't I use a USB flash drive? Or, warning 680 is displayed.	Set the USB mode on the LR8431-20's [System] screen to [USB Memory]. (However, when [USB Memory] is selected, USB communications with the Logger Utility cannot be used.)	"Switching the USB mode" (p.126)

Logger Utility

Question	Remedial Action	Reference page
<p>What kind of program is the Logger Utility?</p>	<p>Running on a PC connected to the HiLogger by USB cable, it provides real time data acquisition, display, and calculation; display and analysis of waveform (binary) data acquired by the HiLogger; conversion of binary data to text (CSV) data; and printing.</p>	<p>Logger Utility instruction manual</p>
<p>What is the method for converting data to a text (CSV) file with the Logger Utility?</p>	<ol style="list-style-type: none"> 1. In the menu bar, select [File]-[Save File in Text Format]. 2. Select a file for CSV conversion in the displayed dialog, and set [CSV (comma separated)] as the file type. 3. Make other settings as necessary, and click the [Save] button. 	<p>Logger Utility instruction manual</p>
<p>The Logger Utility cannot communicate with the LR8431-20. Or, warning 681 is displayed.</p>	<p>Set the USB mode setting on the LR8431-20's [System] screen to [USB Communication]. (However, when [USB Communication] is selected, USB flash drives cannot be used.) If the USB driver has not been installed, install it. If the above procedure cannot be used to establish communications, uninstall the USB driver by deleting "HIOKI 8423, 8430, LR8400 USB Driver" or "HIOKI Logger USB Driver" on the "Add or Remove Programs" screen under "Control Panels." Then reinstall the USB driver.</p>	<p>"Switching the USB mode" (p.126) "Installing the USB Driver"(p.A23)</p>

Appendix 11 Pulse Input Circuit Diagram

The following diagram illustrates an example connection to the instrument's pulse input circuit:

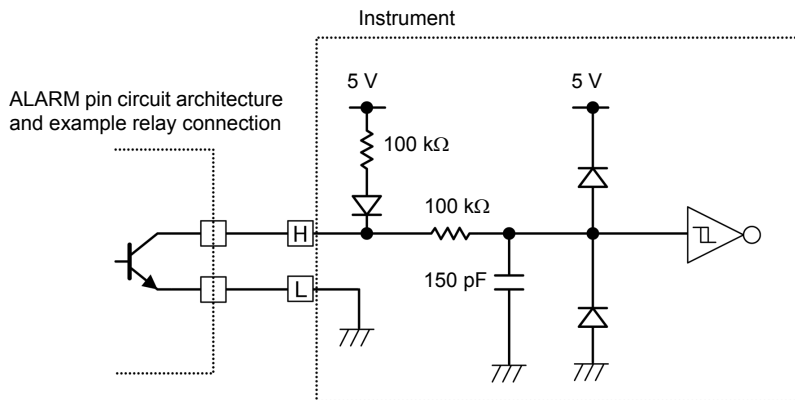

Index

Number

0 pos	56
4-20 mA	32

A

A/B cursors	85
Alarm	67, 73
Alarm Output	73, 134
Analog input terminal	31
AND	71
Auto Calculation	113, 114
Auto Save	47, 96, 97
Average value	113, 117

B

Backlight Brightness	120
Backlight Saver	121
Batch Proc	63, 64
Battery pack	26
Continuous battery-only operating time	28
Beep Sound	121
Binary	91
Burn Out	51

C

Calc(post meas.)	97
Calculation time span	116
CF card	93, 127
Copy	108
Delete	106
Folder	106
Format	95
Load	103
Load Set.	103
Rename	107
Sort	109
Clock Setting	124
Comment	60
Cont	44
Cursor	
Type	85

Cursor values	84
Cursors	
Move	85

D

Decimal Mark	123
Default setting	A 10
Deleting (for saving data)	47
Display Color	121
Display Range	56
Drive	105

E

Error Messages	A 1
Event mark	88
EXT.TRIG	129, 131, 132, 134
External control terminals	129
External Trigger	67, 129

F

File name	A 7
File screen	95, 105
Format (CF card)	95

G

Gauge	84
GND	129, A 15

H

Horizontal cursors	84
--------------------------	----

I

Initializing	64, 125
Installing	A 20
Integration	53

J

Jump	83
------------	----

Index 2

Index

K

Key	
Keys do not work	148
KEY LOCK	16, 23
KEY/LED	127

L

LCD	127
Length (Segment length)	47
Level	68, 69
Level Monitor	24
Level Trigger	68
Load	103, 104
Load Set.	103

M

Maximum value	113, 117
Measurement Configuration	
Setting screen	39
Waveform screen	41
Memory	102, 103
Minimum value	113, 117
Monitor Display	24

N

Noise	A 13
Noise suppression	45
Numerical calculation results	
Save	96
Numerical Calculations	113
Numerical values	87

O

Operating Keys	16
OR	71

P

Peak value	113
Pre-Trig	72

Q

Quick Save	96, 98
------------------	--------

R

Reference time	47
Repair	147

Before Returning for Repair	148
Repeat	45
Revolution Measurement	54
RJC	51
ROM/RAM	127

S

Save	
Auto Save	96
Calc Results	101
File Type	91
Numerical Calculation Results	101
Quick Save	96
Save Set.	102
Screen Image	100
Select & Save	96
Waveform Data	99
SAVE Key Operation	98
Scaling	58
Scrolling	82
Select & Save	96, 98
Self-Test	127
Separator	123
Slope	54
Specifications	137
Start Backup	120
Synchronous Measurements	135
System reset	125
System screen	119

T

Tc	51
Temperature Measurement	51
Time base (horizontal axis)	43
Time Disp	122
Timer	67, 76
Title	60
Trace	82
Trace cursors	84
TRIG.OUT	129
Trigger	67
In	68
Level	68
Out	68
Trigger Input	131
Trigger output	129, 132
Trigger source	71

U

Uninstalling	A 29
USB cable	111, A 26
USB Drive Mode	110
USB driver	A 19, A 23
USB flash driver	
Copy	108
USB mode	126

V

Values	21
Vertical cursors	84
Voltage Measurement	50

W

Waveform	99
Waveform + Calc	97
Waveform Display Color	56
Waveform screen	81
Waveform(realtime)	97
Window Trigger	68

Z

Zero Adjust	35
Zoom (vertical axis expansion/ compression)	56

Index 4

Index

HIOKI

<http://www.hioki.com>



**Our regional
contact
information**

HEADQUARTERS

81 Koizumi, Ueda, Nagano 386-1192 Japan

HIOKI USA CORPORATION

<http://www.hiokiusa.com/> hioki@hiokiusa.com

HIOKI (Shanghai) SALES & TRADING CO., LTD.

<http://www.hioki.cn/> info@hioki.com.cn

HIOKI SINGAPORE PTE.LTD.

www.hioki.com.sg/ info-sg@hioki.com.sg
info-indo@hioki.com.sg (Indonesia)
info-thai@hioki.com.sg (Thailand)
info-vn@hioki.com.sg (Vietnam)

HIOKI KOREA CO., LTD.

<http://www.hiokikorea.com/> info-kr@hioki.co.jp

HIOKI EUROPE GmbH

<http://www.hioki.com/> hioki@hioki.eu

Taiwan Representative Office

<http://www.hioki.com/> info-tw@hioki.com.tw

MEA Representative Office

<http://www.hioki.com/> hioki@hiokimea.ae

1804EN

Edited and published by HIOKI E.E. CORPORATION

Printed in Japan

- CE declarations of conformity can be downloaded from our website.
- Contents subject to change without notice.
- This document contains copyrighted content.
- It is prohibited to copy, reproduce, or modify the content of this document without permission.
- Company names, product names, etc. mentioned in this document are trademarks or registered trademarks of their respective companies.