

ALDAS- α

Check for the latest edition and other language versions.



**Read carefully before use.
Keep for future reference.**

Safety Information ▶ p.10

Measurement Process ▶ p.15

Part Names and Functions ▶ p.18

Maintenance and Service ▶ p.115

Troubleshooting ▶ p.117

EN



Contents

Introduction.....	5
Inspecting Package Contents.....	6
Options (Sold Separately).....	7
Symbols and Abbreviations.....	8
Safety Information.....	10
Precautions for Use.....	12
Measurement Process.....	15

1 Overview 17

1.1 Product Overview and Features.....	17
1.2 Part Names and Functions.....	18
Sense Module.....	18
Source Module.....	20
1.3 System Architecture.....	22

2 Preparing for Measurement 23

2.1 Inspecting the Products Before Use.....	23
2.2 Preparing the PC Application.....	24
Setting the PC's IP Address.....	24
Installing the PC application.....	26
2.3 Connecting the Sense Cable (Voltage Input).....	30
2.4 Connecting the Current Sensor (Current Input).....	31
2.5 Connecting the Source Cable.....	33
2.6 Connecting LAN Cables.....	34
2.7 Connecting the Power Cords.....	35
2.8 Connecting to the Measurement Target.....	36
Measurement with external DC power supply for EC (or external load for FC).....	36
Measurement without an external DC power supply (or external load) (EC or FC).....	39
2.9 Supplying Power to the System.....	41
Turn on the system.....	41
Turn off the system.....	41
2.10 Performing Zero Adjustment and Degaussing (DMAG).....	42

3 Configuring the PC Application 43

USB dongle key.....	43
3.1 Launching the EA5700 ALDAS (PC Application).....	43
3.2 Creating a Measurement Project.....	44
3.3 Connecting to the System Instruments.....	46
3.4 Setting the Measurement Method.....	48
Setting the measurement target (DUT).....	48
Setting the measurement method.....	49
Setting the EIS Mode measurement method.....	50
Setting the Logging Mode (Fixed Frequency) measurement method.....	53
Setting the Logging Mode (Only DCMeasurements) measurement method.....	55
Configuring the Sense Module.....	57
Review measurement settings.....	58
3.5 Main Application Window Overview.....	59
3.6 Measurement Project Files and Folders.....	60

4 Making Measurements 61

4.1 Starting Measurement.....	61
4.2 Checking Conditions During Measurement.....	63
4.3 Stopping Measurement.....	64
4.4 Measuring continuously (When There Are Multiple Measurement Conditions).....	65

5 Checking Impedance Measurement Results 67

5.1 Viewing Data Files.....	67
5.2 Changing the Graph's Configuration Settings.....	71
5.3 Manipulating Data Filters.....	72

1

2

3

4

5

6

7

8

9

10

11

Index

6	I-V Graph Function	75	9	Specifications	103
6.1	Displaying I-V Data	75	9.1	EA5703 ALDAS- α	103
6.2	Changing the I-V Graph Settings	76		General specifications.....	103
6.3	Editing I-V Data.....	78		Functional specifications (PC application functionality)	104
	Editing Cell Information	78	9.2	EA5301 Sense Module.....	107
	Editing the I-V information	79		General specifications.....	107
6.4	Exporting the I-V Data to a File	81		Input, output, measurement specifications	108
7	PC application functions	83		Function specifications.....	111
				Interface specifications.....	111
7.1	Graph Common Operation.....	83	9.3	EA5503 Source Module.....	112
	Setting for Displaying or Hiding the Measurement Data Graph.....	83		General specifications.....	112
	Viewing Graphs	84		Input, output, measurement specifications	112
	Displaying the Data Details on Graphs	85		Interface specifications.....	113
	Setting the Graph Color and Marker Shape	86		Accessories specifications	113
7.2	Manipulating Measurement Conditions Files	87	9.4	L1100 Sense Cable.....	114
	Adding, deleting, sorting, and previewing the measurement conditions	87		General specifications.....	114
	Change the existing measurement conditions	88			
	Adding the existing measurement conditions	89			
	Changing the name of measurement conditions	90			
7.3	Manipulating Data Files.....	91			
	Loading a data file	91			
	Changing a data file's name	93			
	Removing a data file from the list.....	94			
	Exporting data files	96			
7.4	Checking the System Connection Status and Reconnection	98			
7.5	Manipulating Project Files	99			
8	Ending Measurement	101	10	Maintenance and Service	115
8.1	Exiting the PC application	101			
8.2	Turn off the system instruments	101	10.1	Repairs, Inspections, and Cleaning .	115
8.3	Disconnect the cables and current sensor from the measurement target	101		Calibration	115
				Replaceable parts and service life	116
				Cleaning	116
			10.2	Troubleshooting	117
			10.3	Error Messages	118
			10.4	Disposal of the Products	120
			11	Appendix	121
				Impedance measurement during DC operation	121
				Methods for Stabilizing Measurement.....	124
			Index	125	
			Warranty Certificate		

Introduction

Thank you for choosing the Hioki Active Line Device Analysis System (ALDAS).

To ensure your ability to get the most out of this system over the long term, please read this manual carefully and keep it available for future reference.

Information on download site

For details on the product application, the update file for the instrument, and the instruction manual, please check Hioki's website:

<https://cloud.gennect.net/dl>



Website for use within China.

<https://gennect.cn/dl>



Request for product user registration

Please register this product so that you can receive important information regarding the product.

<https://www.hioki.com/global/support/myhioki/registration/>



The following documentation is available for reference according to your application:

Names of the instruction manuals	Contents	Form of supply
Instruction Manual (this manual)	Product overview, operating instructions, function descriptions, and specifications for this system.	Hard copy
Operating Precautions	This document contains information for the safe use of this system. Please read Operating Precautions carefully, before using this system.	Hard copy

Target audience

This manual has been written for use by individuals who use the product or provide information about how to use the product.

In explaining how to use the product, it assumes electrical knowledge (equivalent of the knowledge possessed by a graduate of an electrical program at a technical high school).



Trademarks

- Microsoft Edge and Windows are trademarks of the Microsoft group of companies.
- Adobe and Adobe Acrobat Reader are either trademarks or registered trademarks of Adobe in the United States and other countries.
- Intel is a trademark of Intel Corporation or its subsidiaries in the United States and/or other countries.

Inspecting Package Contents

Upon receiving the products, inspect them for any damage or anomalies. If you discover any damage or find that the product does not perform as indicated in the specifications, please contact your authorized Hioki distributor or reseller.

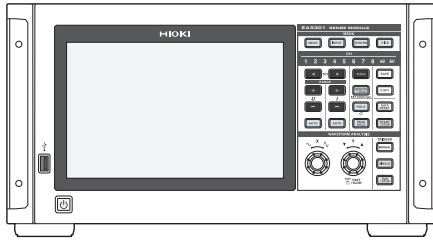
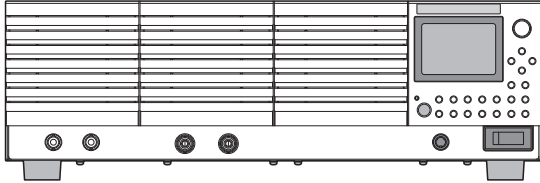
Confirm the package contents.

Product name	Accessories
<p>EA5301 Sense Module "EA5301 Sense Module model number" (p.6)</p> 	<ul style="list-style-type: none"> • Power cord ×1 • Operating Precautions (0990A905) ×1 • Download Guide ×1
<p>EA5503 Source Module</p> 	<ul style="list-style-type: none"> • Power cord × 1 (for main power supply) • AC adapter ×1 (including power cord, for LAN hub) • PBZ20-20 standard accessories (excluding power cord) • Source Cable ×1 Length: 1.2 m Rated current: 20 A • Download Guide ×1 • LAN hub ×1 • LAN cable ×3 Length: 1.0 m
<p>EA5703 ALDAS-α (PC application)</p>  <p>The latest version of the firmware is available for download from Hioki's website.</p>	<ul style="list-style-type: none"> • Z4006 USB Drive ×1 (PC application installer, Instruction Manual*¹) • USB dongle key (license key) ×1 • Instruction Manual ×1 <p>*1. Please visit Hioki's website to check for versions in other languages.</p>

EA5301 Sense Module model number

The branch part of the model number indicates the number of input channels.

Model number (order code)	Number of channels
EA5301-01	1
EA5301-02	2
EA5301-03	3
EA5301-04	4
EA5301-05	5
EA5301-06	6
EA5301-07	7
EA5301-08	8

Options (Sold Separately)



The optional equipment listed below is available for the system. To purchase any optional equipment, please contact your authorized Hioki distributor or reseller. Please note that optional equipment offerings are subject to change without advance notice. For the latest information, check Hioki's website.

Cable for voltage measurement

L1100	Sense Cable (Maximum input voltage: 60 V DC, Cable length: Approx. 2.2 m, banana plug to banana plug, alligator clips included)	
-------	--	---

Products for current measurement

For details, refer to the instruction manual that came with the current sensor.

CT6830	AC/DC Current Probe (2 A)	
CT6831	AC/DC Current Probe (20 A)	
CT6841A	AC/DC Current Probe (20 A)	
CT6872	AC/DC Current Sensor (50 A)	







Replacement Parts

Z1008	AC adapter	AC adapter for LAN hub
Z7038	LAN cable	
Z7043	Source Cable	
Z7051	LAN hub	









Symbols and Abbreviations

Safety

This manual classifies the seriousness of risks and hazard levels as described below.

 DANGER	Indicates an imminently hazardous situation that, if not avoided, will result in death or serious injury.
 WARNING	Indicates a potentially hazardous situation that, if not avoided, could result in death or serious injury.
 CAUTION	Indicates a potentially hazardous situation that, if not avoided, could result in minor or moderate injury or potential risks of damage to the supported product (or to other property).
IMPORTANT	Indicates information or content particularly important from the standpoint of operating or maintaining the product.
	Indicates a high-voltage hazard. Failure to verify safety or improper handling of the product will result in an electric shock, a burn, or injury, potentially leading to death.
	Indicates a prohibited action.
	Indicates the action which must be performed.

Symbols on the product

	Indicates the presence of a potential hazard. For more information about locations where this symbol appears on products' components, see "Precautions for Use" (p. 12) and warning messages listed at the beginning of operating instructions. In addition, see the accompanying document entitled "Operating Precautions" and "Current Sensor".
	Indicates the on position of the power switch.
	Indicates the off position of the power switch.
	Indicates the push-button switch that can turn on and off the product.
	Indicates the grounding terminal.
	Indicates the chassis terminal. The terminal is connected to the enclosure of the product.
	Indicates that touching the part directly could result in a burn.
	Indicates that the product can be used to measure alternating current (AC) voltage/current or can be powered by utility AC power.

Symbols for various standards

	Indicates that the product is subject to the Directive on Waste Electrical and Electronic Equipment (WEEE) in EU member nations. Dispose of the product in accordance with local regulations.
	Indicates that the product complies with standards imposed by EU directives.
	Indicates that the product complies with Korean regulations. EA5301 SENSE MODULE Declarer: HIOKI KOREA CO., LTD. http://www.rra.go.kr/selform/HKO-EA5301S
	EA5503 SOURCE MODULE Model/Device Name: PBZ20-20/Bipolar Power Supply Declarer: KIKUSUI ELECTRONICS CORPORATION
	Z7051 LAN HUB Model/Device Name: C1200-8T-D/Switch Declarer: CISCO SYSTEMS, INC.
	Z1008 AC ADPTER Model/Device Name: MPU16A-105/Switching Power Supply Declarer: Sinpro Electronics Co.,Ltd.

Others

*	Indicates that additional information is described below.
(p.)	Indicates the page number to reference.
START (Bold)	The letters and key names on the screen are highlighted in bold.
[]	The names of user interface elements on the screen are enclosed in brackets ([]).
Windows	Unless otherwise noted, the term Windows is generically used to refer to Windows 11.

Accuracy labeling

The accuracy of the measuring instrument is expressed by defining limit values for errors as a percentage of the reading and a percentage of the range.

Reading (display value)	Indicates the value displayed on the measuring instrument. Limit values for reading errors are expressed as a percentage of the reading (% of reading or % rdg).
Range	Indicates the measurement range of the measuring instrument. Limit values for range errors are expressed as a percentage of the range (% of range or % rng).

Safety Information

The products included in this system has been designed in accordance with the international standard IEC 61010 and has undergone rigorous safety testing prior to shipment. However, using the system in a way not specified in this manual may compromise its safety features. Carefully read the following safety notes before use.

DANGER



- **Familiarize yourself with the contents of this manual before use.**

Failure to follow this guidance will result in misuse, leading to serious bodily injury or damage to the products.

WARNING



- **If you have not previously used electrical measuring instruments, ensure adequate supervision by a technician with experience in electrical measurement.**

Failure to follow this guidance could result in electric shock. It could also cause serious incidents, such as heat generation, fire, or arc flash due to a short-circuit.

Measurement categories

IEC 61010 defines measurement categories to ensure the safe use of measuring instruments. Test and measurement circuits are classified into three categories based on the type of mains they are intended to be connected to. A measuring instrument that does not have a measurement category cannot be used to measure a main power supply circuit.

DANGER

- Do not use a measuring instrument to measure a main power supply circuit whose category exceeds the instrument's rated measurement category.



- Do not use a measuring instrument that does not have a rated measurement category to measure a main power supply circuit.

Doing so may result in serious bodily injury or damage to the instrument or other equipment.

No measurement category (O)	Applicable to the measurement of other circuits that are not directly connected to the main power supply. EXAMPLE: Measurement on the secondary-side equipment from the socket outlet of fixed installation through a transformer, etc.
Measurement category II (CAT II)	Applicable to test and measuring circuits connected directly to utilization points (socket outlets and similar points) of a low-voltage mains installation. EXAMPLE: Measurements on household appliances, portable tools, and similar equipment, and on the consumer side only of socket outlets in the fixed installation.
Measurement category III (CAT III)	Applicable to test and measuring circuits connected to the distribution part of a building's low-voltage mains installation. EXAMPLE: Measurements on distribution boards (including secondary meters), photovoltaic panels, circuit breakers, wiring, including cables, bus-bars, junction boxes, switches, and socket outlets in a fixed installation, as well as equipment for industrial use and some other equipment such as stationary motors with permanent connection to the fixed installation.
Measurement category IV (CAT IV)	Applicable to test and measuring circuits connected at the source of the a building's low-voltage mains installation. EXAMPLE: Measurements on devices installed before the main fuse or circuit breaker in the building installation.

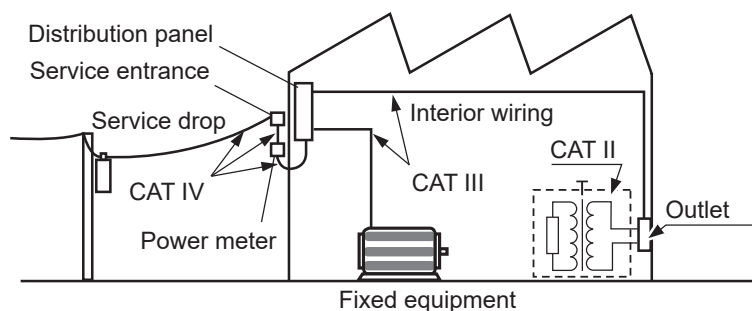

Precautions for Use

Be sure to follow the precautions listed below in order to use the system safely and in a manner that allows it to function effectively.

Use of the system should conform not only to its specifications, but also to the specifications of all accessories, options, and other equipment in use.

Installing the system

WARNING

Do not install the system in the following locations:

- Locations with direct sunlight exposure or high temperatures
- Locations where corrosive or explosive gases are generated
- Locations with powerful electromagnetic radiation exposure or electrostatic charges
- Close to inductive heating devices (high-frequency inductive heating devices, IH cooktops, etc.)
- Places where there is a lot of mechanical vibration
- Locations exposed to water, oil, chemicals, or solvents
- Places with high humidity or condensation
- Locations with an excessive amount of dust
- Locations with an unstable or inclined position



Doing so could damage the system or cause it to malfunction, resulting in bodily injury.

- **Place the Source Module, leaving enough space around it to facilitate unplugging the power cord.**



If there is not enough space left around, the power cannot be shut off immediately in an emergency.

Failure to follow this guidance could result in bodily injury, fire, or damage to the system.

CAUTION

- **When placing the Sense Module on top of the Source Module, take measures to prevent them from tipping over or falling, such as securing them with Velcro belts.**



If not secured properly, the Sense Module could tip over or fall, causing damage.

- Leave the specified distance of space from the modules to prevent their temperature from rising.
Sense Module: At least 30 mm (all surfaces except bottom) and at least 15 mm (height of support legs) above surface on which installed
Source Module: Provide enough spacing for ventilation and cable connections.
- Place with its bottom side facing downward.
- Do not block vent openings.

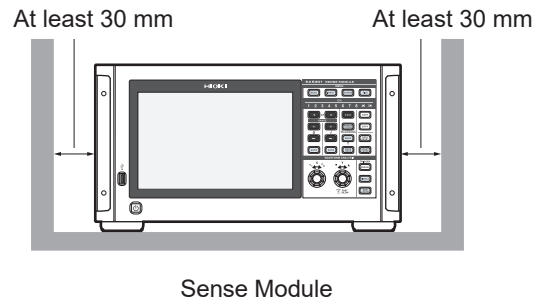

The modules are classified as a Class A device under the EN 61326 standard. Use of them in a residential setting such as a neighborhood could interfere with reception of radio and television broadcasts. If this occurs, take appropriate steps to counteract the issue.

Cautions for measurement

DANGER



- **Do not use the system to measure circuits that exceed the ratings or specifications of the system.**

Doing so could cause damage to the system or overheating, resulting in serious bodily injury.

WARNING



- **Do not measure a voltage of 20 V DC or more.**
- **Do not touch the wires being measured.**
- **When connecting measurement cables, exercise care not to mistake voltage input terminals for current input terminals.**

The wires being measured could become hot, possibly resulting in burns.
Mistaking these cables could damage the system or cause the circuit under measurement to short-circuit, resulting in bodily injury.

Cautions for transporting the products

CAUTION



- Do not subject the products to vibration or mechanical shock while transporting or handling them.

- Do not drop the products.

Failure to follow this guidance could damage the products.



- At least two people are required to lift the Source Module, one holding the left side and another holding the right side.

Source Module weight: Approx. 22.0 kg

- Follow your company's safety guidelines, such as using anti-slip gloves and safety boots.

Failure to follow this guidance could cause bodily injury.

Shipping precautions

- When shipping the system, use the original boxes and packaging materials in which they were delivered. However, do not use the original boxes and packaging materials if they are damaged. If the original boxes and packaging materials cannot be used, contact your Hioki distributor. You will be sent suitable boxes and packaging materials.
- When packing the system, disconnect test leads and a USB flash drive.
- When transporting the system, exercise care to avoid dropping them or otherwise subjecting them to rough handling.

Warranty

- Please note that in the event the system is embedded in another system or sold to another owner, Hioki is not liable for any direct or indirect damage sustained by the end-user.
- The L1100 Sense Cable and Source Cable are not covered by the warranty.

Measurement Process

The basic measurement procedure is as follows:

1 Conduct a pre-measurement inspection

"2.1 Inspecting the Products Before Use" (p.23)

2 Prepare for measurement

"2.2 Preparing the PC Application" (p.24)
 "2.3 Connecting the Sense Cable (Voltage Input)" (p.30)
 "2.4 Connecting the Current Sensor (Current Input)" (p.31)
 "2.5 Connecting the Source Cable" (p.33)
 "2.6 Connecting LAN Cables" (p.34)
 "2.7 Connecting the Power Cords" (p.35)

3 Connect the measurement target

"2.8 Connecting to the Measurement Target" (p.36)
 "2.9 Supplying Power to the System" (p.41)
 To allow high-precision measurement, it is recommended to allow the system to warm-up for at least 30 min. between the time it is turned on and the start of measurement.
 "2.10 Performing Zero Adjustment and Degaussing (DMAG)" (p.42)

4 Configure the PC application

"3 Configuring the PC Application" (p.43)

5 Perform measurement

"4.1 Starting Measurement" (p.61)
 "4.3 Stopping Measurement" (p.64)

6 Check the measurement results

"5 Checking Impedance Measurement Results" (p.67)

7 Ending measurement (p.101)

1.1 Product Overview and Features

This product is an Active Line Device Analysis System (ALDAS) that can conduct electrochemical impedance spectroscopy (EIS) measurements and plot I-V graph characteristics simultaneously for electrolysis cell (EC) or fuel cell (FC) during its operation.

- **Impedance measurement with excellent reproducibility**

The system is capable of delivering accurate and consistent impedance measurements, even in environments with a lot of electrical noise, such as those from electrolysis devices in operation.

- **Simultaneous multichannel measurement**

The Sense Module can measure up to eight channels simultaneously.

- **Cole-Cole plots (Nyquist plots)**

The system can perform impedance measurement and generating Cole-Cole plots (Nyquist plots) based on user-defined frequency lists ranging from 0.01 Hz to 100 kHz.

- **Extended duration impedance measurement**

The system can measure impedance at a user-defined frequency and fixed interval, logging readings up to 180 days.

- **Parameter comparisons on the graph**

The measured data can be compared on a graph instantly to verify the measurement parameters of the experiment.

- **I-V graph**

The system plots the I-V graphs based on the DC current and DC voltage values acquired simultaneously with impedance measurements.

1.2 Part Names and Functions

Sense Module

Front side

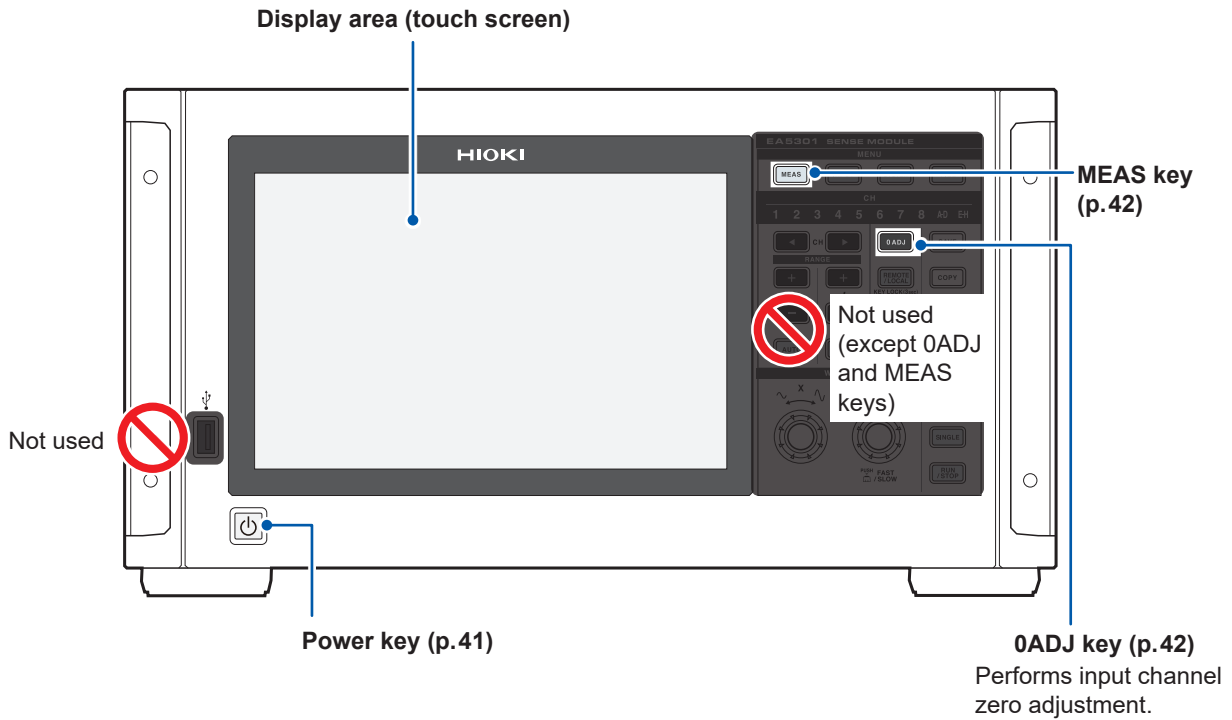

Handling the touch screen

CAUTION



- Do not press too hard on the touch screen.
 - Do not use hard or sharp objects to operate the touch screen.
- Failure to follow this guidance could damage the module.

Rear side

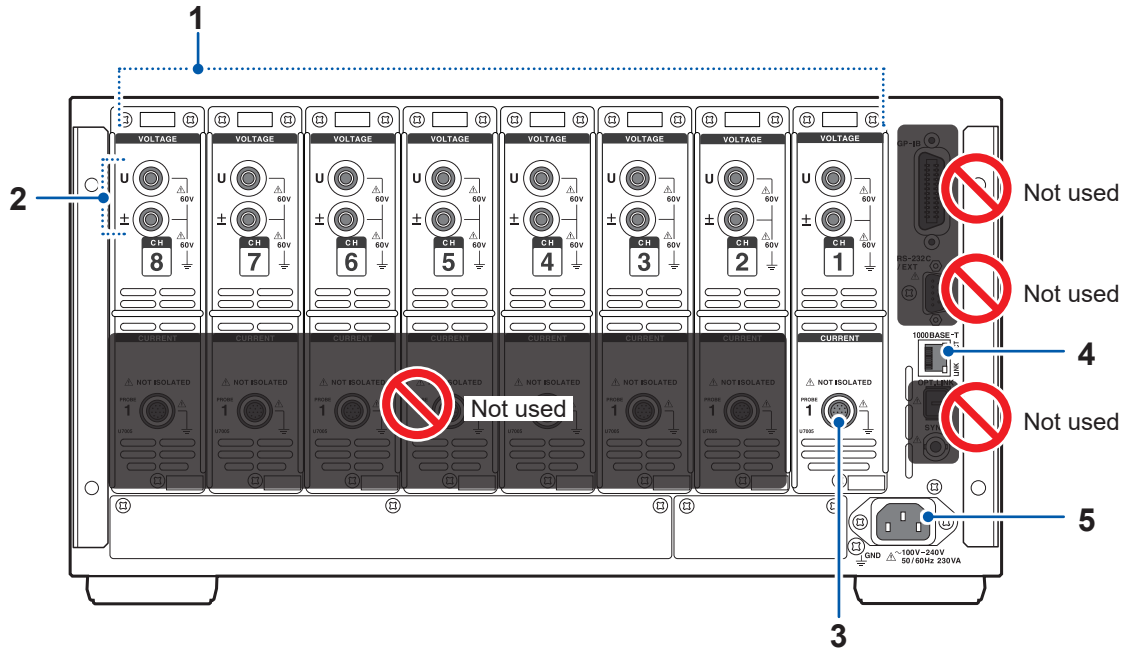

1	Input channels	The Sense Module accepts up to eight voltage input channels. (Specify the number of input channels when ordering.)	p.6
2	Voltage input terminals	Connect the L1100 Sense Cable.	p.30
3	Probe 1 terminals (For current sensors)	Connect Hioki's current sensors. The Sense Module automatically recognizes current sensors. It also supplies power to the current sensors.	p.31
4	RJ-45 connector (Gigabit Ethernet)	Connect the Sense Module with a LAN cable.	p.34
5	Power supply inlet	Connect the included power cord to the power supply.	p.35

Right side

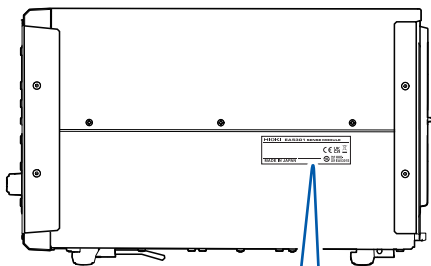

Left side

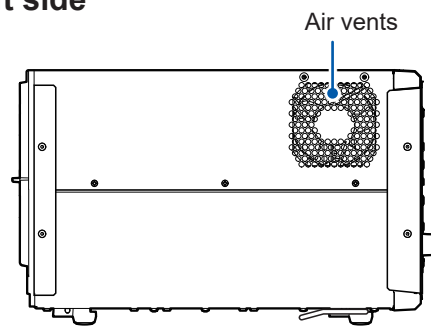

Label

Model number Serial number* MAC address

* Serial number
Please check Hioki's website for the latest information.
Do not remove this sticker. It contains important information required for future service and support.

Source Module

Front side

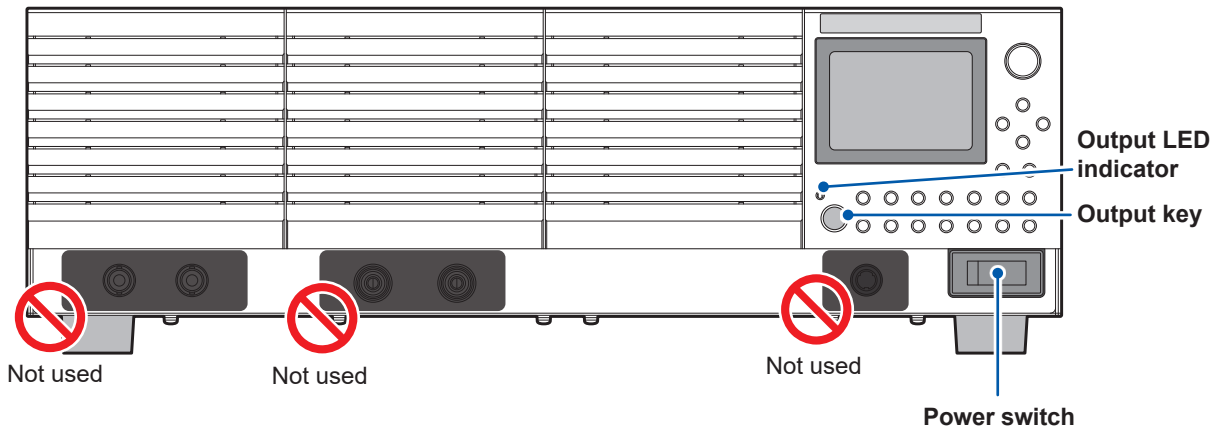

Rear side

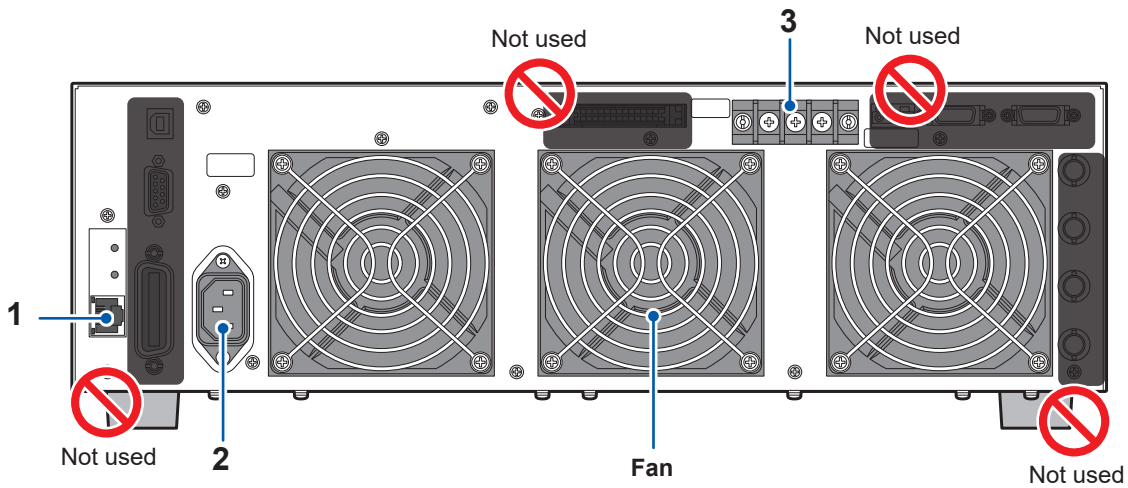

1	LAN	Ethernet port to control the Source Module remotely.	p.34
2	Power inlet	Connect the included power cord to the power supply.	p.35
3	OUTPUT terminal	Connect the ground (middle) to the green wire of the Source Cable. The COM and OUT terminal are connected to the black and white wire of Source Cable respectively.	p.33

Right side

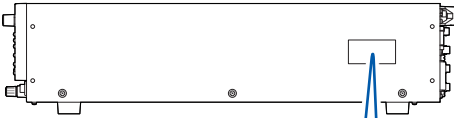

Left side

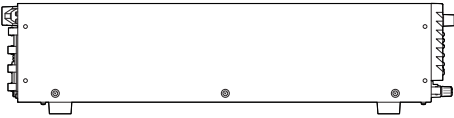

Label

*1 Serial number
For the latest information, check Hioki's website.
Do not remove this sticker because the number is required for product tracking.

Serial number*1 MAC address

A diagram of a label with the brand name 'HIOKI' at the top. Below the name is a solid horizontal line. Underneath this line, there is a dotted rectangular box. A blue line points from the text 'Serial number*1' to a dot on the left side of the dotted box. Another blue line points from the text 'MAC address' to a dot on the right side of the dotted box.

1.3 System Architecture

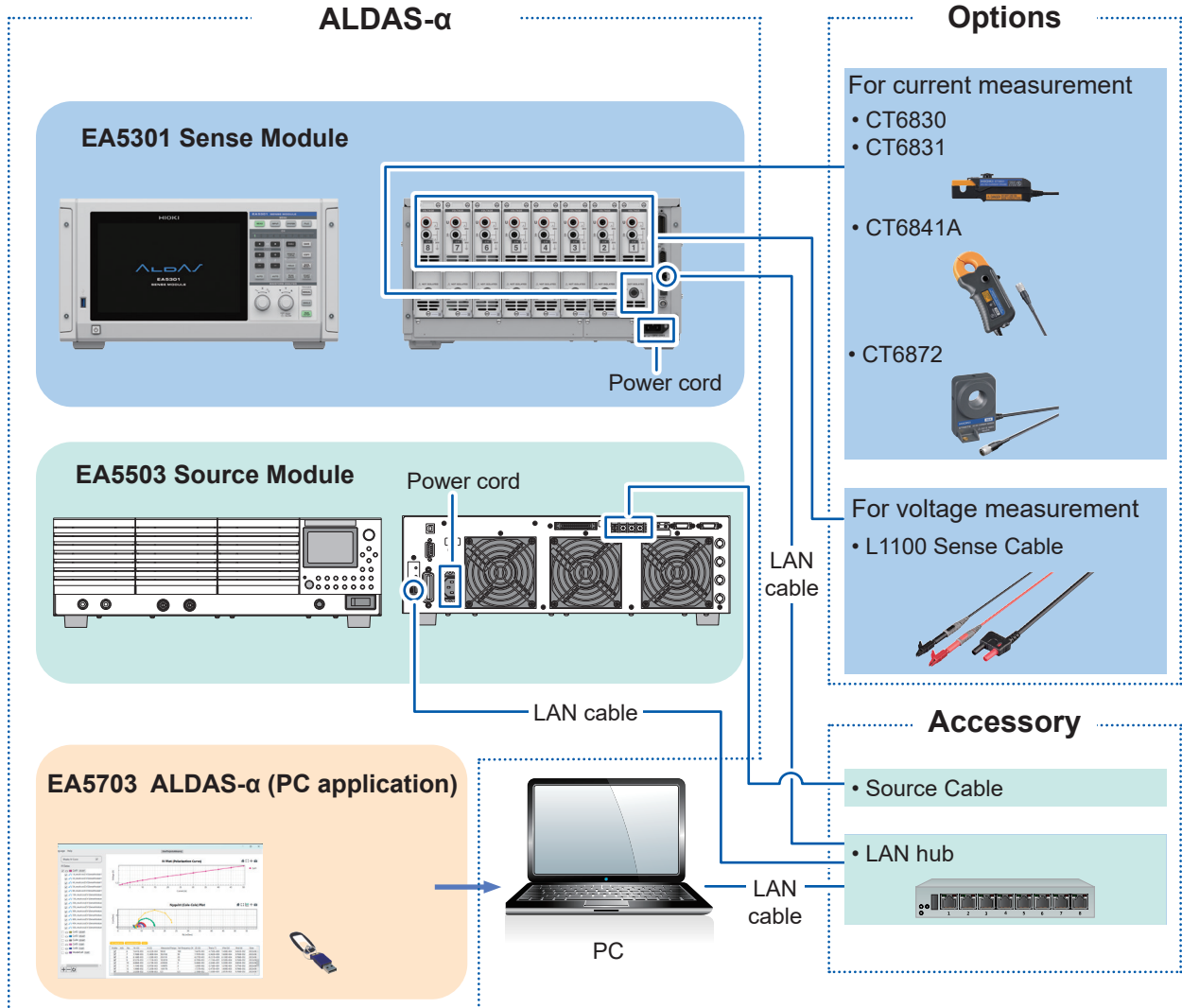

2

Preparing for Measurement

2.1 Inspecting the Products Before Use

Before starting measurement, inspect the system including the modules, accessories, and optional equipment.

DANGER



■ **Inspect the system and verify proper operation before use.**

Use of the system while it is malfunctioning could result in serious bodily injury. If you find any damage, contact your authorized Hioki distributor or reseller.

2

Inspecting accessories and optional equipment

Make sure that . . .	Action
Insulation of the power cords, Sense Cable, and Source Cable are not damaged. No metal is exposed.	Do not use damaged products with the system to avoid electric shock or short circuits. The system cannot perform measurements in this state. Contact your authorized Hioki distributor or reseller.
The current sensor's clamps are not cracked or damaged.	

Inspecting the system

Make sure that . . .	Action
The products are not damaged.	If damage is found, request repair.
The Sense Module displays [EA5301 SENSE MODULE] when turned on.	If [EA5301 SENSE MODULE] is not displayed, there could be damage to the power cord or a product malfunction. Please contact your authorized Hioki distributor or reseller.

2.2 Preparing the PC Application

For more information about system requirements, please see "(1) PC application operating environment" (p.103).

Setting the PC's IP Address

- 1 Press the Windows key and the R key at the same time.
The [Run] dialog box will be displayed.

- 2 Enter [ncpa.cpl] in the [Open] box and click [OK].

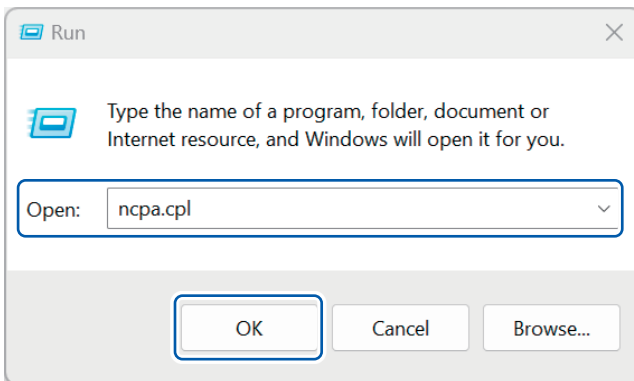

- 3 From the [Network Connections] window, double-click the selected Ethernet port for connecting the PC application with the system.

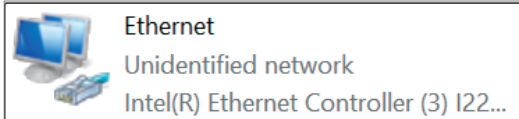

The [Ethernet Properties] dialog box will appear.

- 4 Select [Internet Protocol Version 4(TCP/IPv4)] and click [Properties].

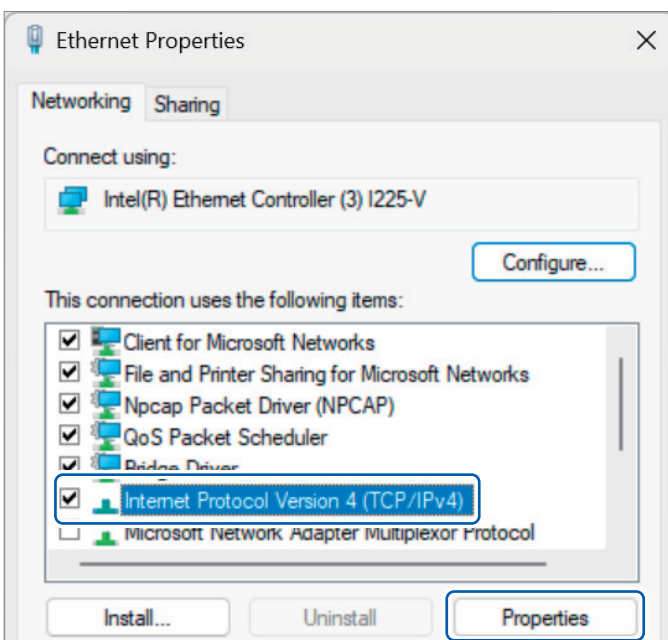

5 Set the [IP address] to 192.168.200.200.

The recommended setting range is from 192.168.200.5 to 192.168.200.255.

The following IP addresses cannot be used as they are reserved for the system's operation:

192.168.200.1 to 192.168.200.4

6 Set the [Subnet mask] setting to 255.255.0.0.

7 Leave the [Default gateway] setting blank.

8 Click [OK].

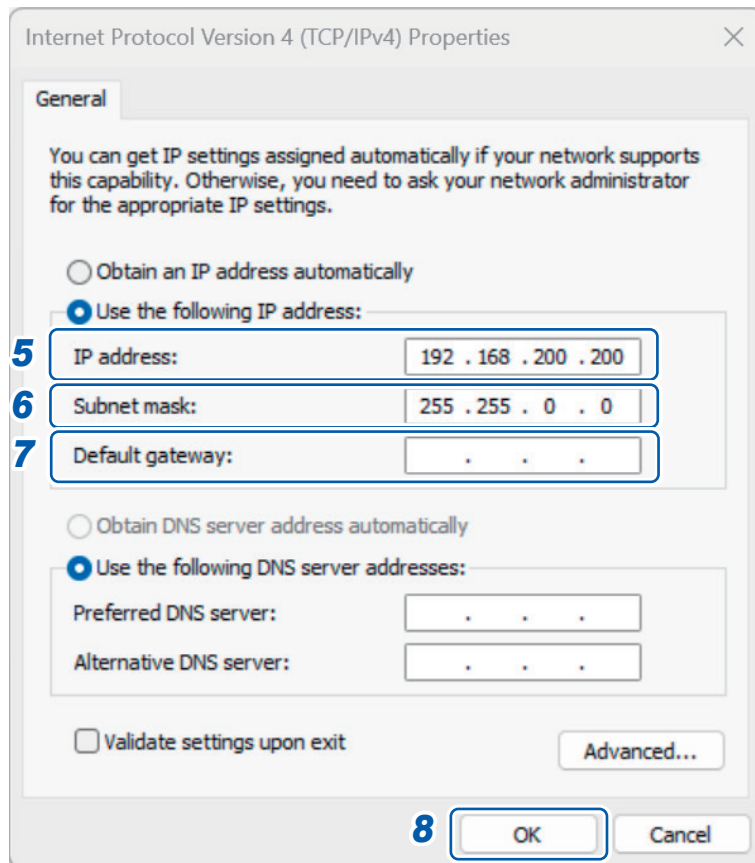

Installing the PC application

Procedures

- 1** Log in to the PC using an administrator account.
- 2** Exit all running applications on PC.
- 3** Insert the USB drive with EA5700 application software into the PC's USB port.
- 4** Double-click the installer `[setup_HIOKI EA5700 ALDAS_V (version number).exe]`.

When the installation mode selection screen appears:

Select **[Install for all users]**.

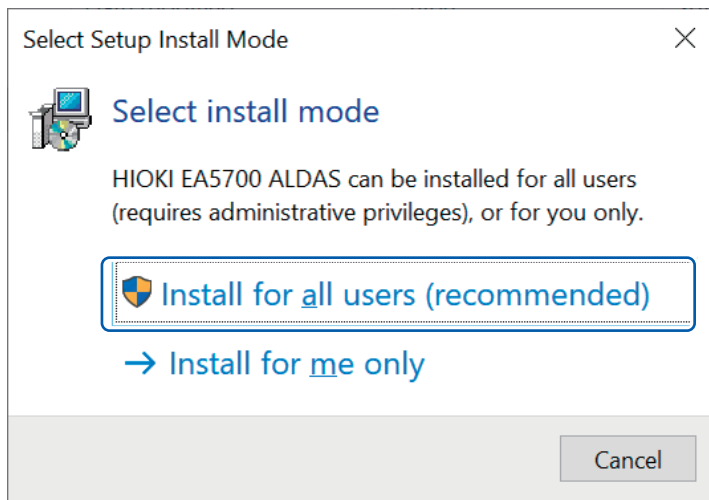

- 5** Select a language and click **[OK]**.

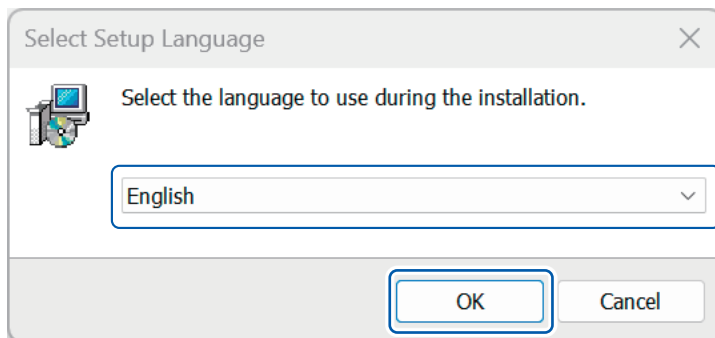

The **[Welcome to the HIOKI EA5700 ALDAS setup Wizard]** dialog box will be displayed.

6 Click **[Next]**.

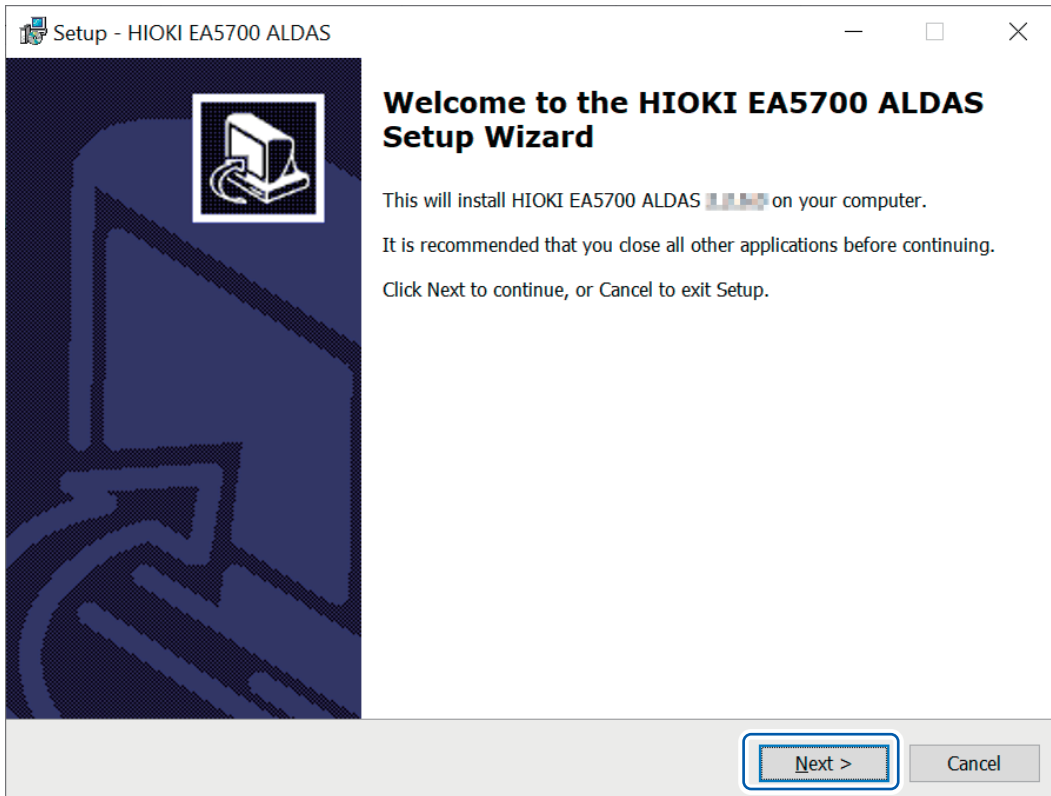

The **[License Agreement]** dialog box will be displayed.

7 Read the **[User's License Agreement]** and select the **[I accept the agreement]** option button. Click **[Next]**.

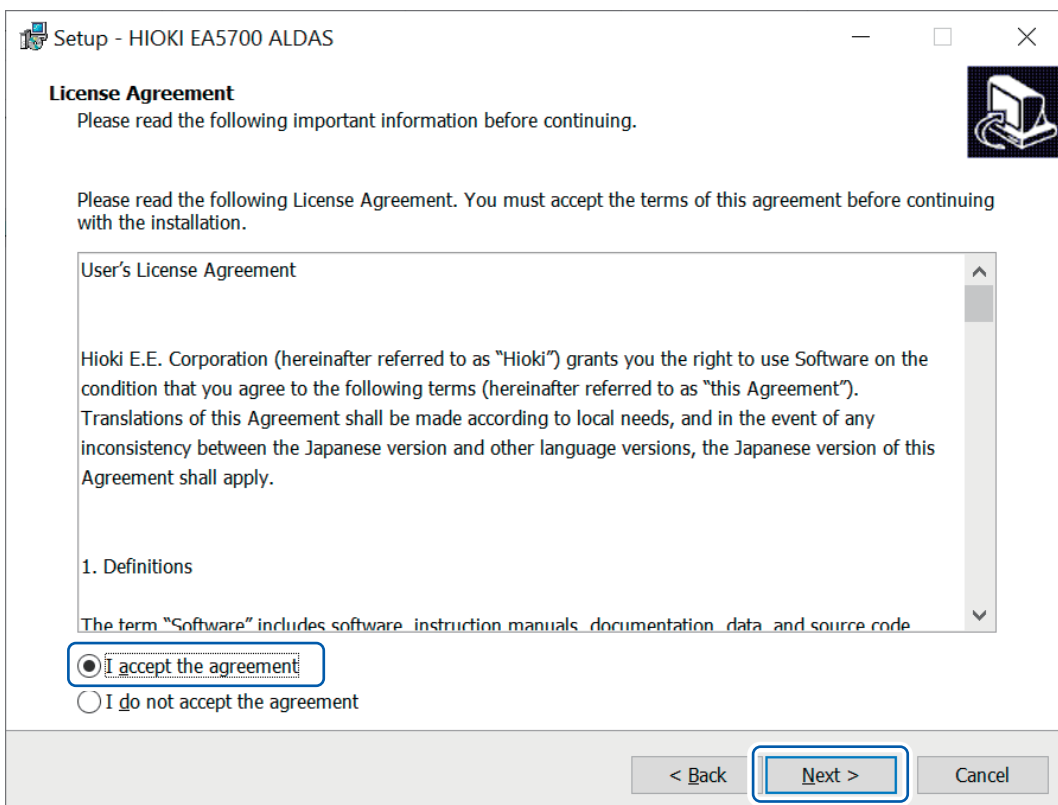

8 Confirm that the **[Create a desktop shortcut]** checkbox is selected and click **[Next]**.

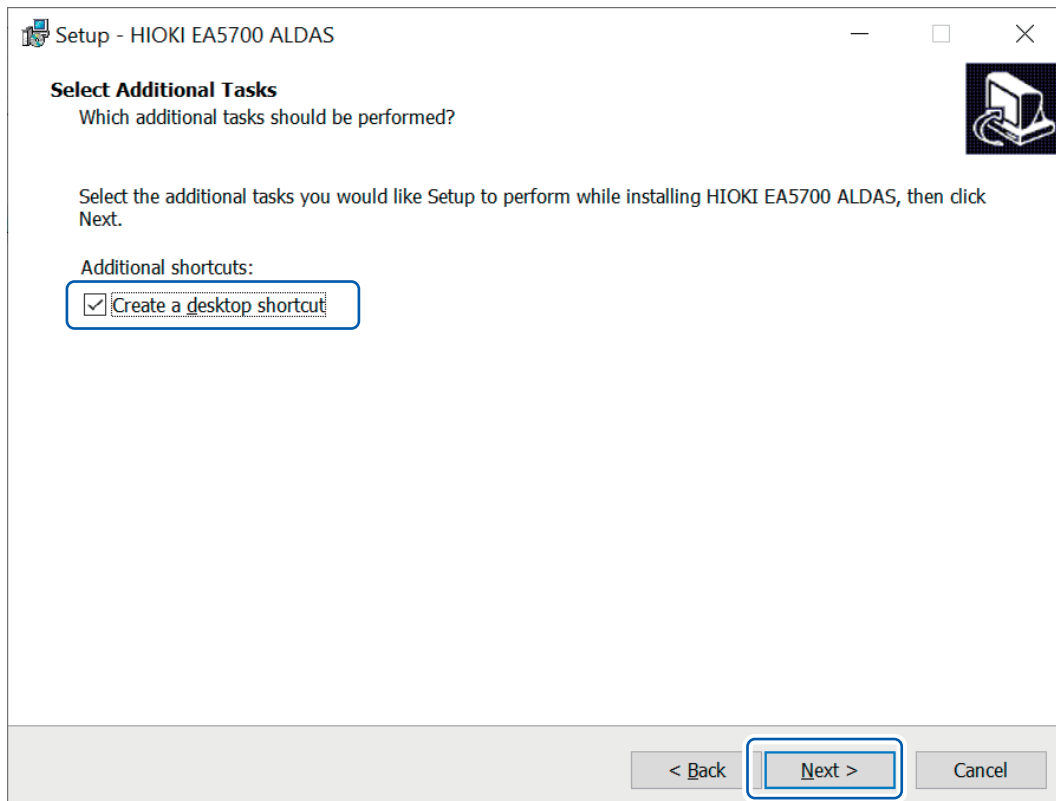

9 Review the information on the dialog box and click **[Install]**.

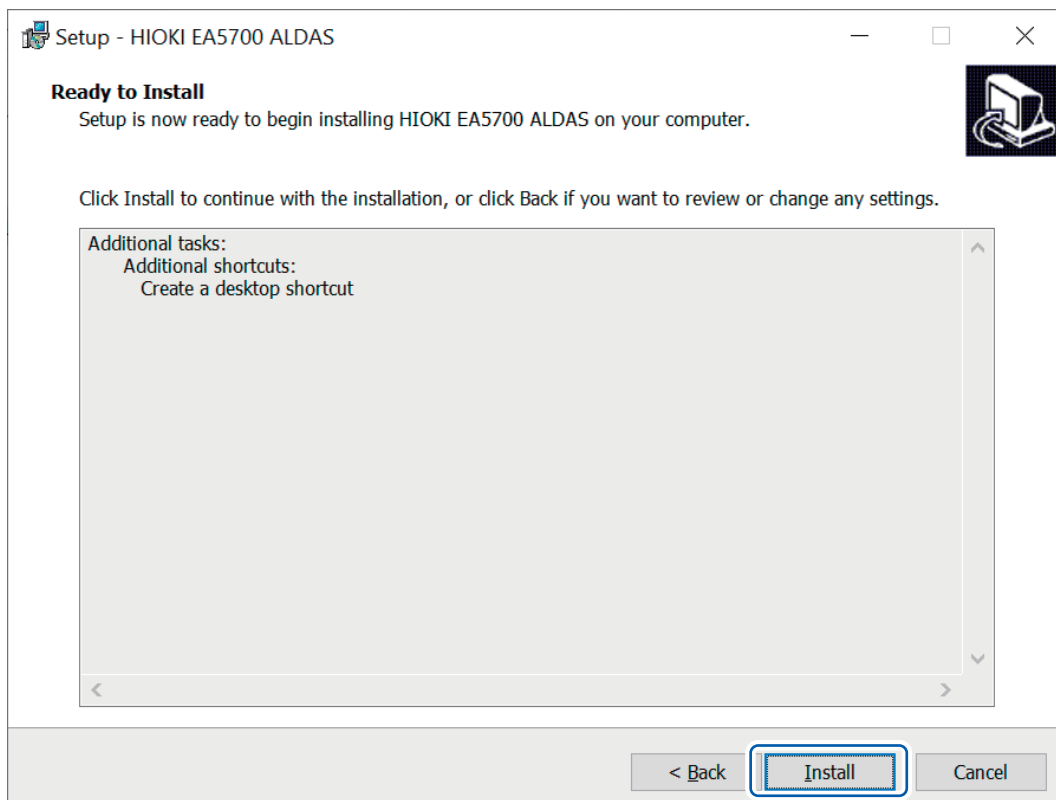

10 Once the installation has completed, click **[Finish]**.

If the **[Launch HIOKI EA5700 ALDAS]** checkbox is selected, the PC application will start.

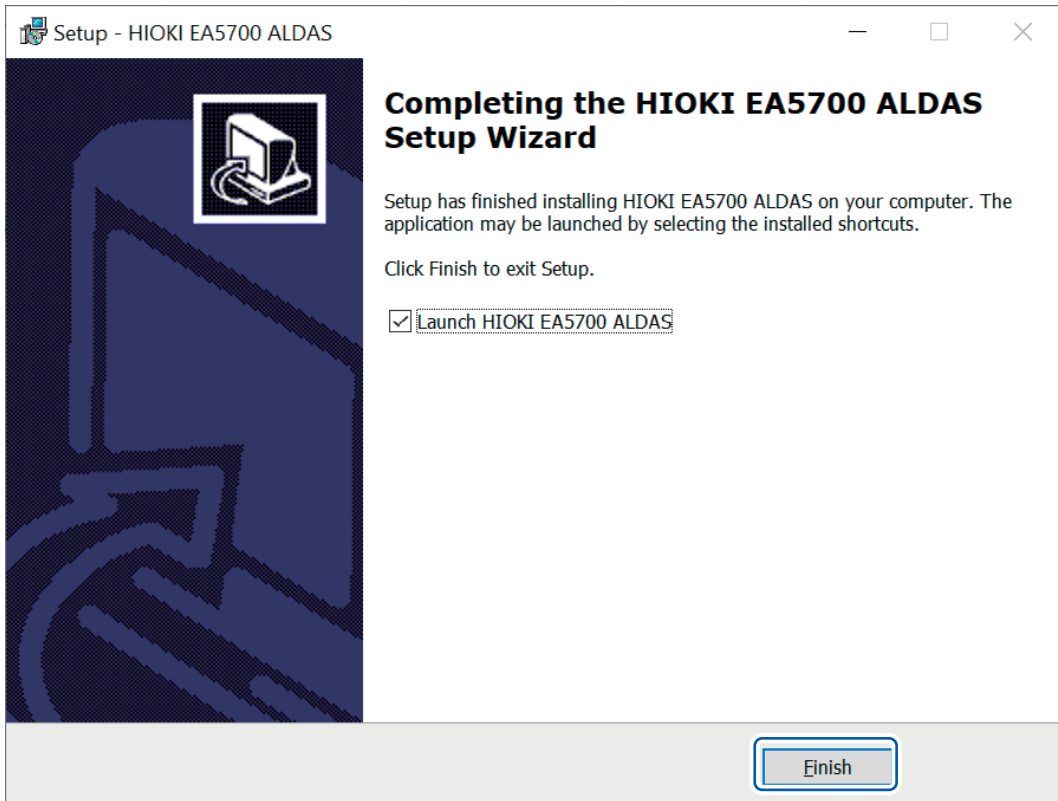

2.3 Connecting the Sense Cable (Voltage Input)

Connect the L1100 Sense Cable to the voltage input terminal on the back of the Sense Module. Connect the necessary number of Sense Cables depending on the number of channels available on the Sense Module and the number of cells to be measured.

⚠ WARNING



- Turn off the DC power source to the measurement target before connecting the cables.

Failure to do so could potentially damage the modules, resulting in bodily injury.

IMPORTANT

For accurate measurement, ensure the Sense Cable is firmly and fully inserted.

Rear panel of the Sense Module

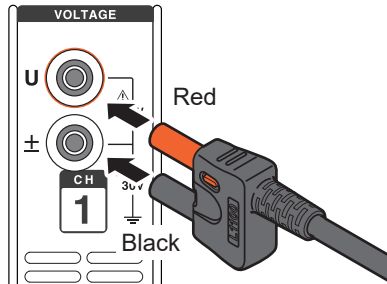

- 1 Turn off the Sense Module.

- 2 Insert the Sense Cable into the voltage input terminals.

Insert the red plug into the terminal labeled "U" and the black plug into the terminal labeled "±".

2.4 Connecting the Current Sensor (Current Input)

Connect the current sensor to the Probe 1 terminal on the Sense Module.

⚠ DANGER

- ⊘
 - **Do not use the current sensors to measure a circuit carrying a voltage greater than the maximum rated line-to-ground voltage.*¹**
 - **Do not use the current sensors for measuring bare conductors.**
Doing so could result in serious bodily injury or a short circuit.
*1 For details about the maximum rated line-to-ground voltage of the current sensor, refer to the instruction manual that came with the current sensor.
- !
 - **Connect the current sensor to the Probe 1 terminal only.**
Using a current sensor other than the option listed in this manual may result in serious personal injury.

⚠ CAUTION

- ⊘
 - **Do not connect or disconnect connectors while the modules have been turned on.**
Doing so could damage the sensor.

IMPORTANT

- Do not drop a current sensor onto a floor or other surface.
- Do not subject the current sensor to mechanical shocks.
Doing so could adversely affect the current sensor's measurement accuracy and the opening/closing mechanism.

For detailed specifications and instructions for the current sensors being used, refer to the instruction manual that came with the current sensors.

How to plug the connector

IMPORTANT

Always connect the current sensor to CH1 (Probe 1 terminal) only, even when measuring voltage on multiple channels.

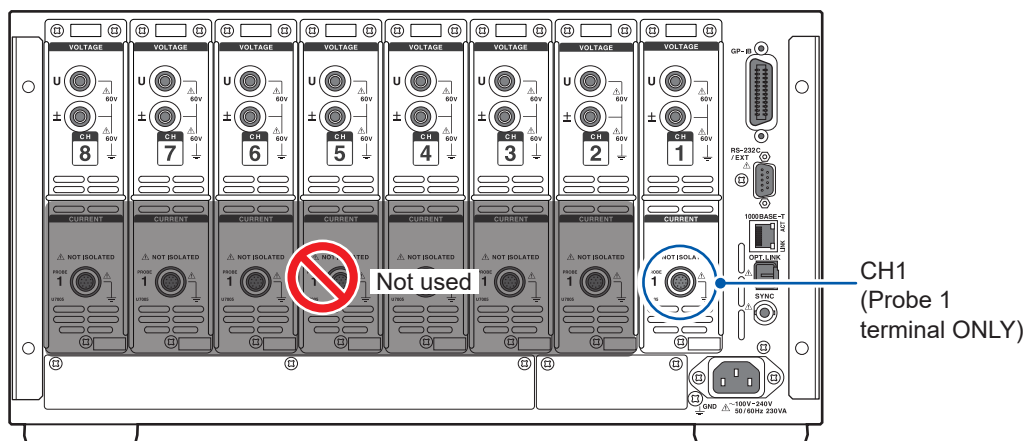

Connecting the Current Sensor (Current Input)

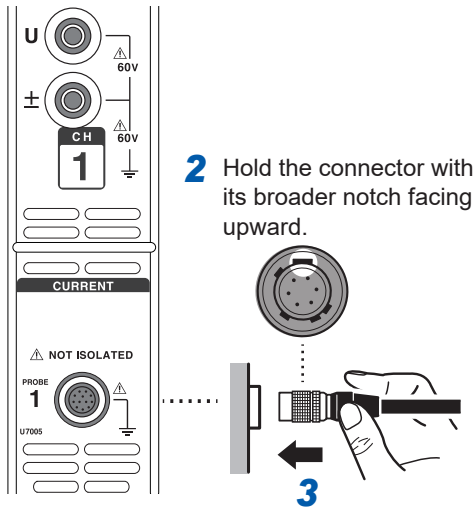

- 1 Turn off the Sense Module.
- 2 Align the positions of the connector guides of the Sense Module and the current sensor.
- 3 Hold the plastic part of the connector and insert it straight until it is locked.

The Sense Module automatically recognizes the type of current sensor when it is plugged in.

How to unplug the connector

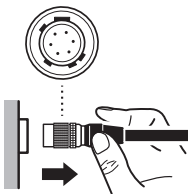

- 1 Hold the metallic part of the connector and slide it toward the cable side to unlock the connector.
- 2 Pull out the connector.

2.5 Connecting the Source Cable

Connect the Source Cable to the terminal on the back of the Source Module.

⚠ WARNING

- Turn off the DC power source to the measurement target before connecting the cords.

Failure to do so could potentially damage the modules, resulting in bodily injury.



- Turn off the power to the Source Module before disconnecting the Source Cable.

When disconnecting the Source Cable from the Source Module, keep all screws and the cable itself away from the fan. Loose items caught in the fan can damage the module and cause bodily injury.

IMPORTANT

For accurate measurement, ensure the Source Cable is firmly secured and attached to the Source Module terminal.

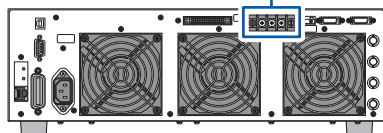
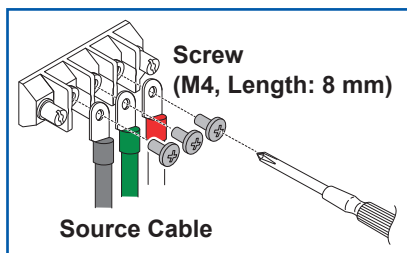

Source Module

- 1 Turn off the power switch for the Source Module.
- 2 Remove the terminal cover.
- 3 When connecting the Source Cable, it is recommended to first attach the green wire to the ground terminal of the Source Module to fix it before attaching other wires.
- 4 When performing measurements without an external DC power source (or external load), it is recommended to insert or clamp the current sensor before attaching the cable to the terminals.
- 5 It is recommended to twist the positive (white) and negative (black) wire as a countermeasure against external inductive noise.
- 6 Attach the positive (white) to OUT and negative (black) to the COM terminal.
- 7 After securing all three Source Cable wires, attach the terminal cover.

2.6 Connecting LAN Cables

Connect LAN cables to the RJ-45 (Gigabit Ethernet) connectors to the LAN hub.

! CAUTION



- **Do not unplug LAN cables while measurement is in progress.**
Doing so could damage the modules and the computer.



- **If routing LAN cables over more than 30 m, attach LAN surge protectors or other suitable protective devices.**
Failure to do so could cause damage to the system due to increased susceptibility to the effects of induced lightning.
- **Turn off the products and computer before connecting or disconnecting cables.**
Failure to do so could damage the modules and the computer being connected or cause them to malfunction.

- 1 Turn off the Source Module power.**
- 2 Connect the LAN cable from the Sense Module, Source Module and PC via the provided LAN hub.**

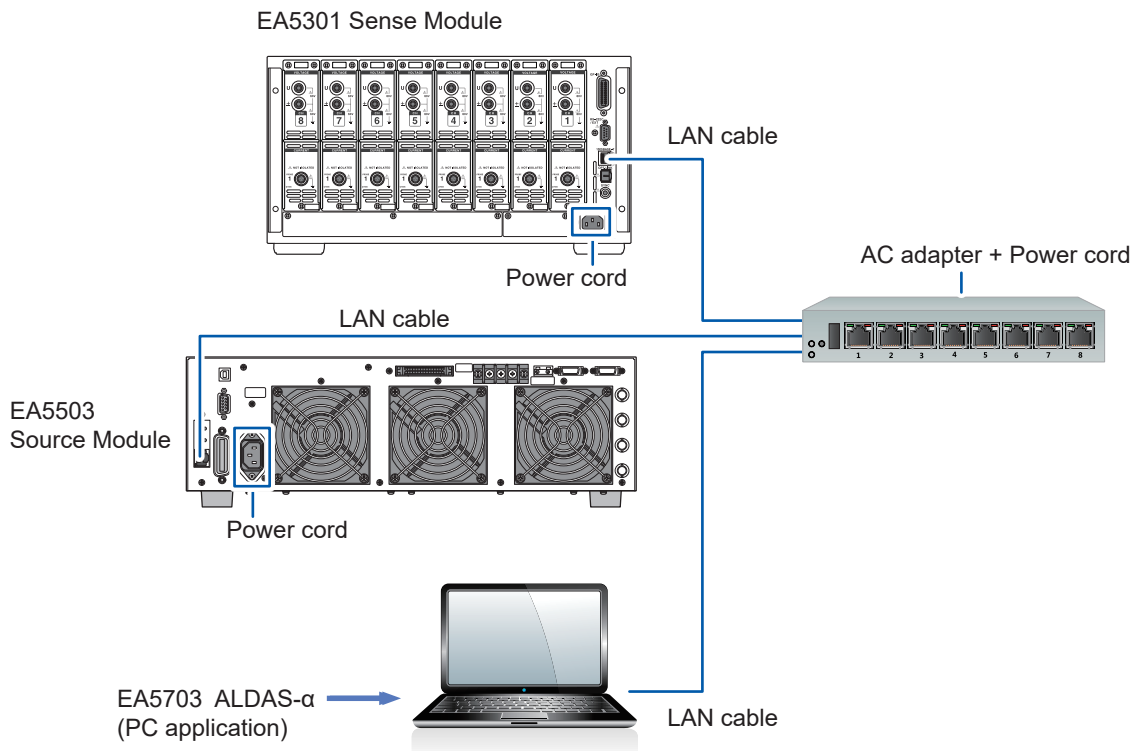

2.7 Connecting the Power Cords

⚠ DANGER



- **Use only the specified power cord to provide power to the modules.**

Using a power cord other than those specified could cause a fire, resulting in serious bodily injury.

⚠ CAUTION



- **Before connecting the power cords, verify that the your supply voltage falls within the supply voltage range noted on the AC inlets of the modules.**

Supplying a voltage that falls outside the specified range to the modules could damage them, causing bodily injury.

- **Ground the ground terminals of the modules and the equipment to be connected at a same location.**

Failure to do so could damage the modules and the devices being connected or cause them to malfunction.

- 1** Connect the included power cord to the Sense Module power inlet and its power cord plug to main power supply outlet.
- 2** Verify that the main power supply voltage falls within the rated range (100 to 240 V AC) and connect the included power cord (for the main power supply) to the Source Module's power inlet and connect the power cord to the main power supply outlet.
- 3** Connect the LAN hub's power cord plug to main power supply outlet.

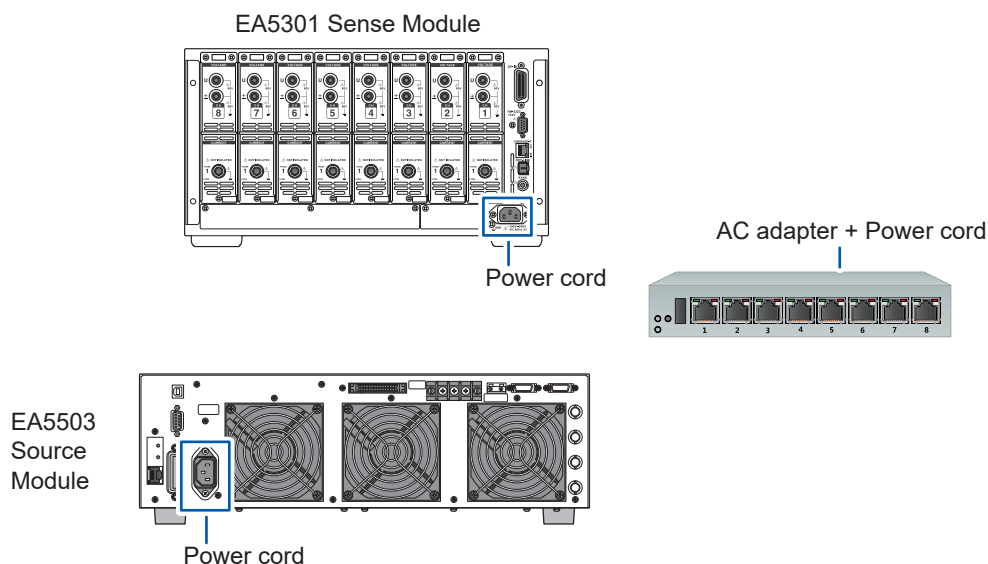

2.8 Connecting to the Measurement Target

Connect the Sense Cables, current sensor, and Source Cable to the measurement target.

DANGER

- **Do not connect to measurement target that exceed 20 V DC.**

Doing so could cause damage to the system or overheating, resulting in serious bodily injury.



- **Do not short the positive and negative measurement lines with the metal part of the Sense Cable clip.**

Doing so can cause arc flash, resulting in serious bodily injury or damage to the system or other equipment.

- **Never touch the metal areas on test leads or at the tips of voltage cords during measurement.**

Doing so could result in serious bodily injury or a short circuit.

WARNING



- **After turning off the measurement target's power and the modules, connect the Sense Cables, current sensor, and Source Cable.**

Doing so could damage the products, resulting in bodily injury.

CAUTION



- **Connect the white Source Cable to the positive terminal [high-potential] and the black cable to the negative terminal [low-potential].**

Connecting the cables with incorrect polarity can cause damage to the Source Module.

Measurement with external DC power supply for EC (or external load for FC)

- 1 Turn off the external DC power supply to the measurement target and verify that it is completely de-energized.
- 2 Make sure that the Sense and Source Module of the measurement system is off.
- 3 Connect the Source Cable (black, green, white) to the Source Module (COM, ground, OUT) terminals.

See "2.5 Connecting the Source Cable" (p.33).

- 4 Prepare **two relay cables** with same length to connect the positive and negative side of the measurement target (DUT) to the Source Cable (white and black).

The relay cable is not provided with this product. Please prepare a suitable relay cable in compliance with the measurement target's DC current specification.

Example of a relay cable:  Length: About 20 cm

- 5 Connect both the other end of the Source Cable (white and black) with the relay cables and cables connected to external DC power supply or load with nut and screw.

6 For a clamp-type sensor, proceed to the next step.

For a through-hole-type current sensors: Clamp the current sensor around the relay cable (positive or negative) and follow the current sensor's direction depending on the DUT below:

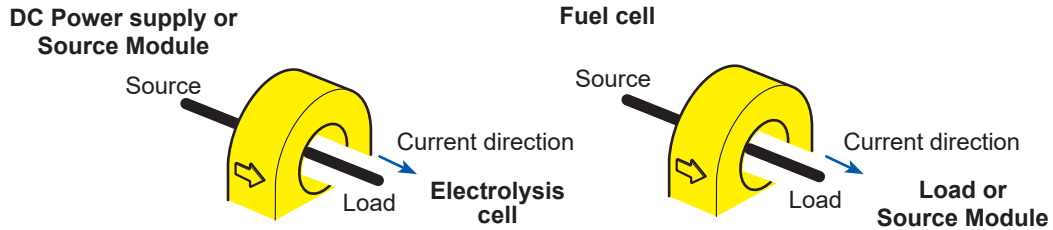

7 Then connect relay cable with current sensor on one side and without on the other side to the measurement target terminals (positive and negative) and secure it with nut and screw.

8 Finally, attach the Sense Cable for voltage measurement. It can be attached directly to the measurement target terminal. If the clamp-type current sensor is used, clamp the sensor around the relay cable following the same current sensor direction in step 6 and pay attention to the clamp precaution below.

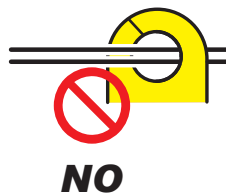
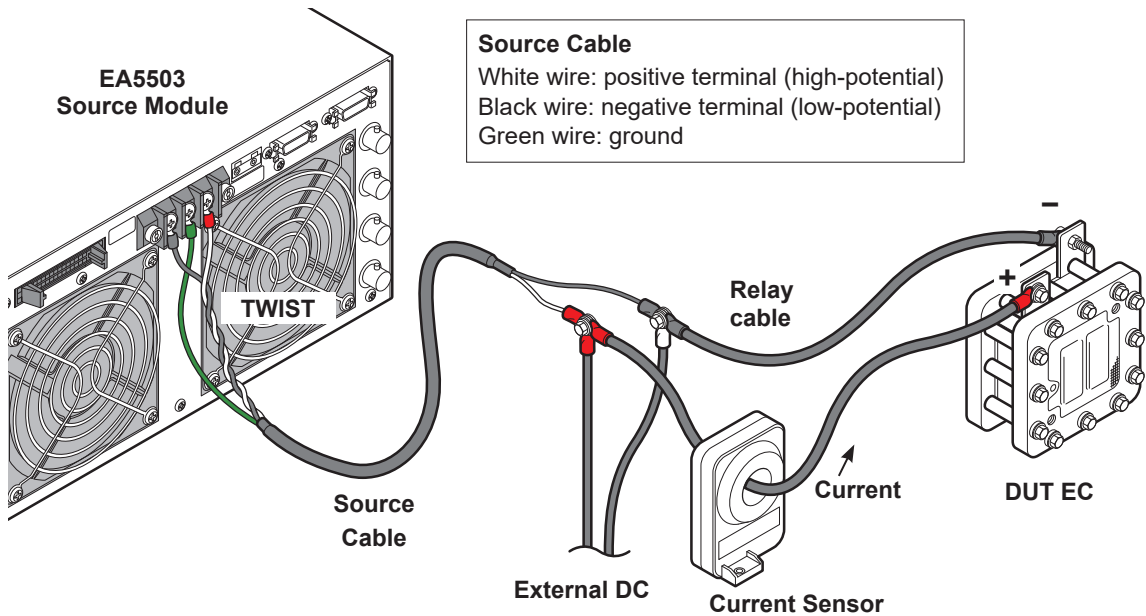

Do not clamp the sensor around two or more conductors.

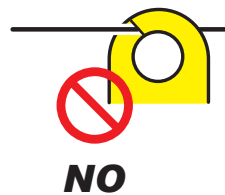

Do not pinch the conductor.

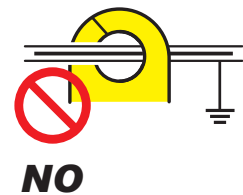

Do not clamp the sensor to a shielded wire.

Connection Diagram

(1) For a single cell

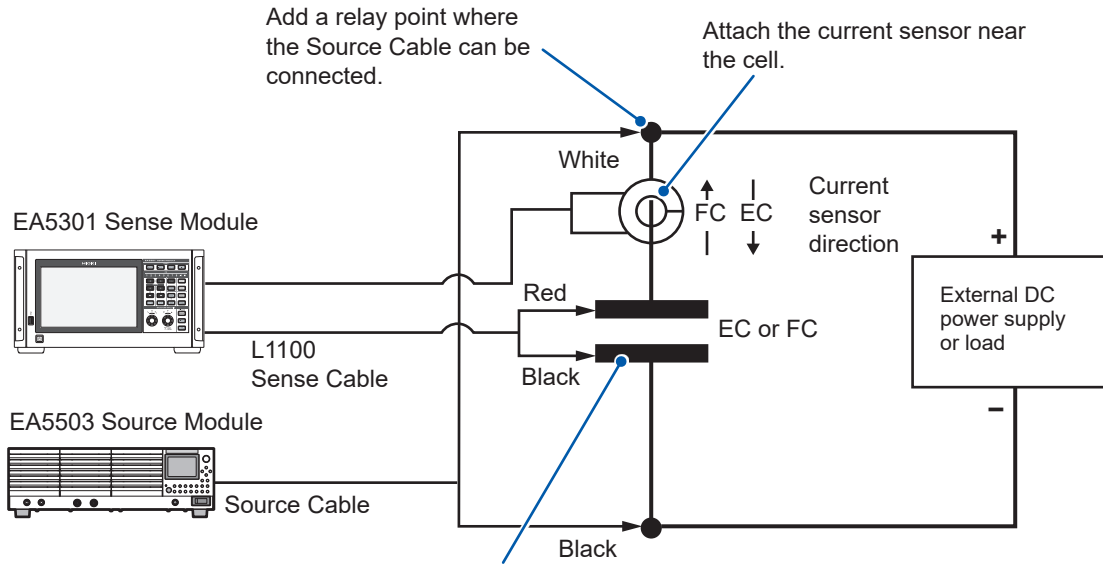

Connect the Sense Cable to the measurement target terminal where the voltage can be measured (e.g., current collector plate, cell separator).

(2) For multiple cells (stack)

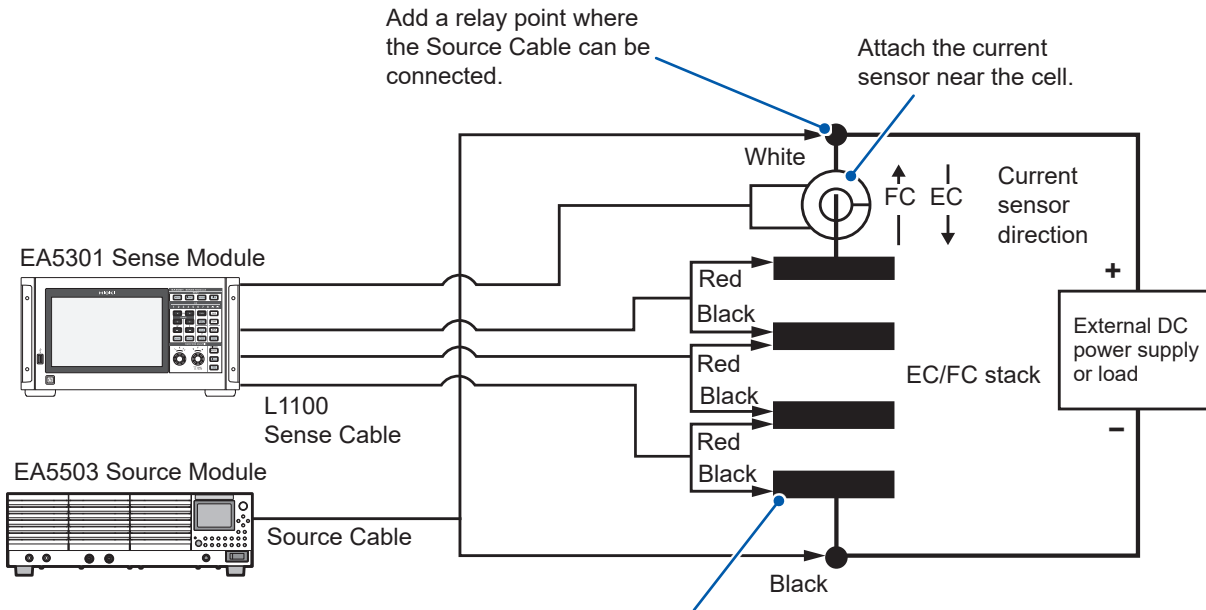

Connect the Sense Cable to the measurement target terminal where the voltage can be measured (e.g., current collector plate, cell separator).

Measurement without an external DC power supply (or external load) (EC or FC)

- 1** Make sure that the Sense and Source Module of the measurement system is off and verify that the measurement target is completely de-energized.
- 2** Attach the green wire to the ground terminal of the Source Module to fix it before attaching other wires.
See "2.5 Connecting the Source Cable" (p.33).
- 3** Insert or clamp the current sensor around one of the remaining Source Cable wires (white or black) and follow the current sensor's direction depending on the DUT below:

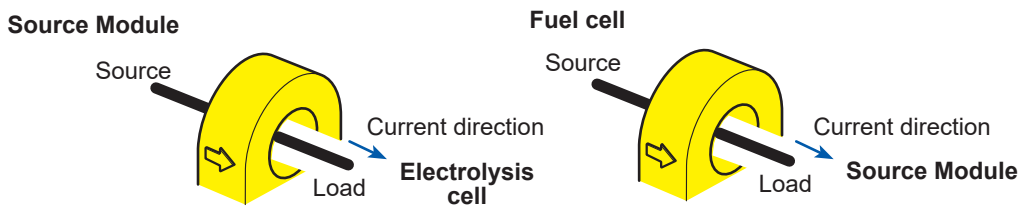

- 4** Then twist the Source Cable's white and black wires before securing it to the Source Module OUT and COM terminals. It is recommended to twist the wire as close as possible as a countermeasure against external inductive noise.
- 5** Connect the other end of Source Cable to the measurement target terminal as shown in figure below.
- 6** Finally, attach the Sense Cable for voltage measurement. It can be attached directly at the measurement target terminal.

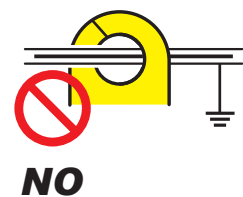
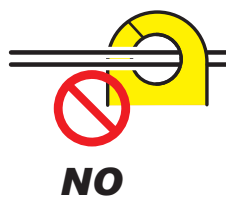
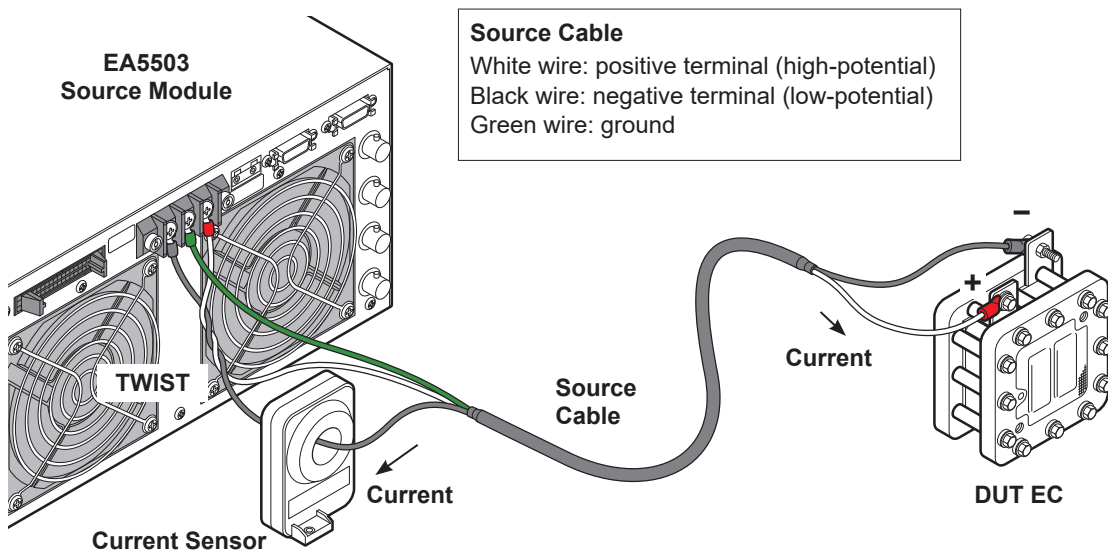

Do not clamp the sensor around two or more conductors.

Do not pinch the conductor.

Do not clamp the sensor to a shielded wire.

Connection diagram for measurement without an external DC power supply

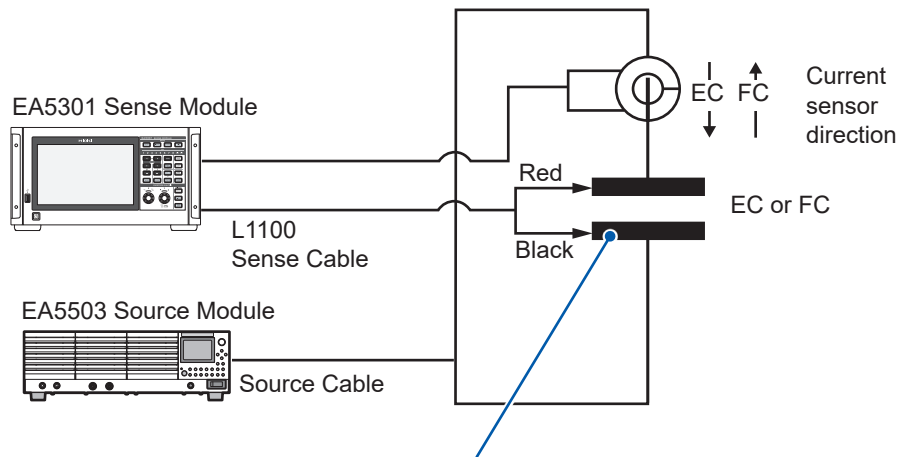

Connect the Sense Cable to the measurement target terminal where the voltage can be measured (e.g., current collector plate, cell separator).

2.9 Supplying Power to the System

Turn on the system

- 1 Switch on the Source Module power switch.**
The Source Module will start up.
- 2 Press the POWER button on the Sense Module.**
The Sense Module is turned on.
- 3 Let the system warm-up for at least 30 minutes before starting the measurement.**

Turn off the system

CAUTION



- **Ensure the measurement target's DC power supply is turned off and the system detects no voltage or current before shutting down the system.**

Failure to do so may result in system damage.

- 1 Turn off the external DC power supply if it is connected to the measurement target.**
Skip this step for measurements without an external DC power supply (or external load), or for FC.
- 2 Verify that there is no voltage or current detected from the measurement target by the Sense Module.**
- 3 Press the Power button on the Sense Module to switch it off.**
The Sense Module will turn off.
- 4 Switch off the Source Module power switch.**
The Source Module will turn off.

2.10 Performing Zero Adjustment and Degaussing (DMAG)

Zero adjustment is performed for all input channel ranges simultaneously. The current sensor will also be degaussed (DMAG) at the same time.

- 1 Verify that the measurement target is powered off and has no input detected for both voltage and current measurement.
- 2 Press the **MEAS** key (p.18).
- 3 Press the **0ADJ** key (p.18).
- 4 If a confirmation dialog is shown on the Sense Module's display, tap **[Yes]**.

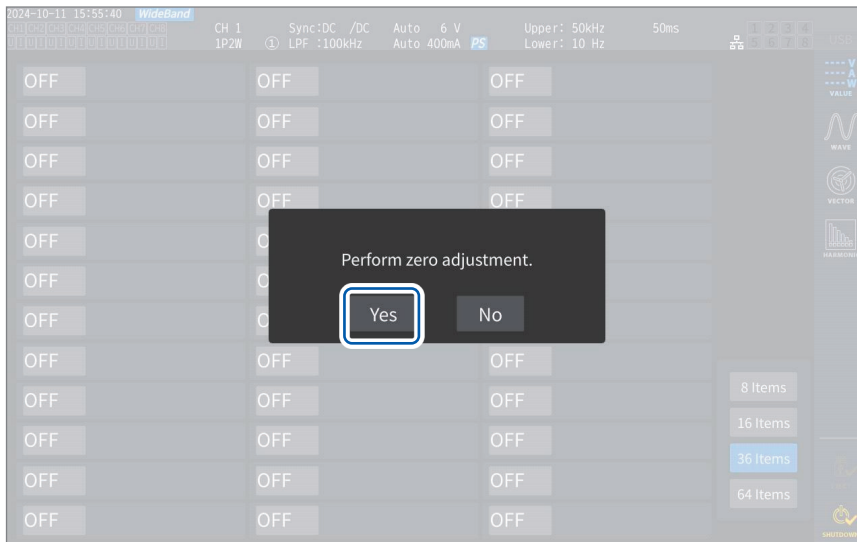

The message **[Performing zero adjustment...]** will be displayed, and zero adjustment will complete in about 30 seconds.

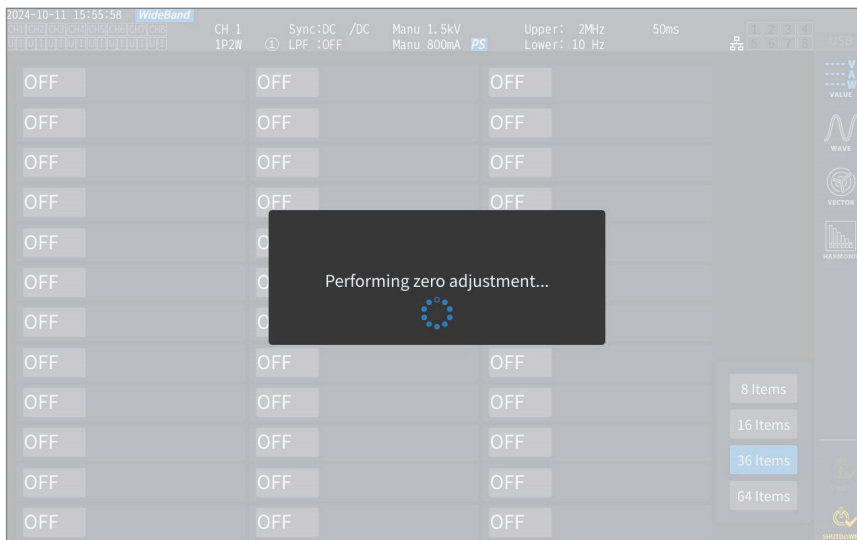

3

Configuring the PC Application

USB dongle key

CAUTION



- Take steps to ensure that static electricity is not applied to the USB dongle key.

Application of static electricity could damage the USB dongle key, or cause the system to malfunction. Additionally, the system could fail to start.

IMPORTANT

The EA5700 ALDAS will perform license authentication when it is launched and at the start of every measurement.

Do not remove the USB dongle key while the application is running.

Please make sure that the dongle matches the measurement software and hardware. Just insert only 1 dongle; do not put in multiple dongles to start the operation.

Insert the USB dongle key into the PC's USB port.

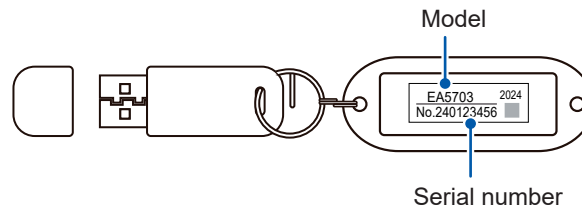

3

3.1 Launching the EA5700 ALDAS (PC Application)

- 1 Insert the USB dongle key into the USB port of the PC with the EA5700 ALDAS installed.
- 2 Double-click the  icon on the PC desktop to launch the EA5700 ALDAS after installing the PC application (p.26).

The EA5700 ALDAS window will open.

If the USB dongle key is not inserted when the EA5700 ALDAS is launched, a pop-up message shown below will be displayed.

Click **[OK]** to exit the application and then relaunch the application after inserting the USB dongle key.

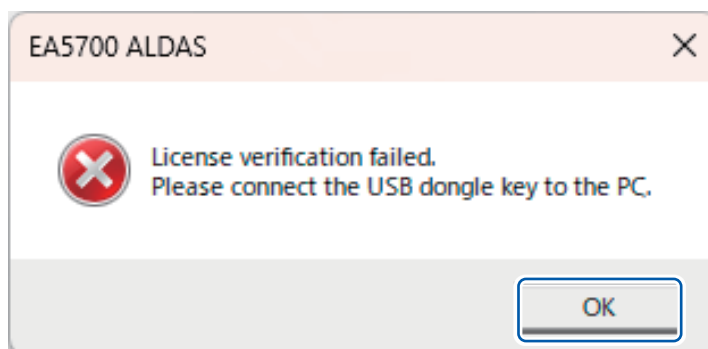

3.2 Creating a Measurement Project

A measurement project's file consists of measurement conditions, hardware information, measurement target information and measurement results. When a project file **[ProjectName.aldasproj]** is opened, information such as the previous measurement results and setting conditions can be restored and loaded. Follow the steps below to create a measurement project.

1 Click **[New]** in the **[HOME]** tab.

The **[Project Settings]** window will be displayed.

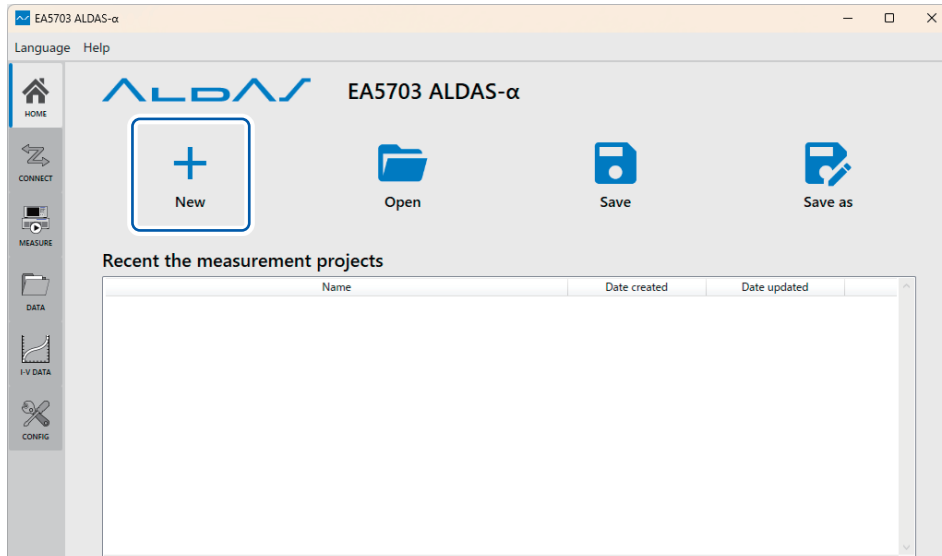

2 Click **[Browse]** to select the location to save the project file.

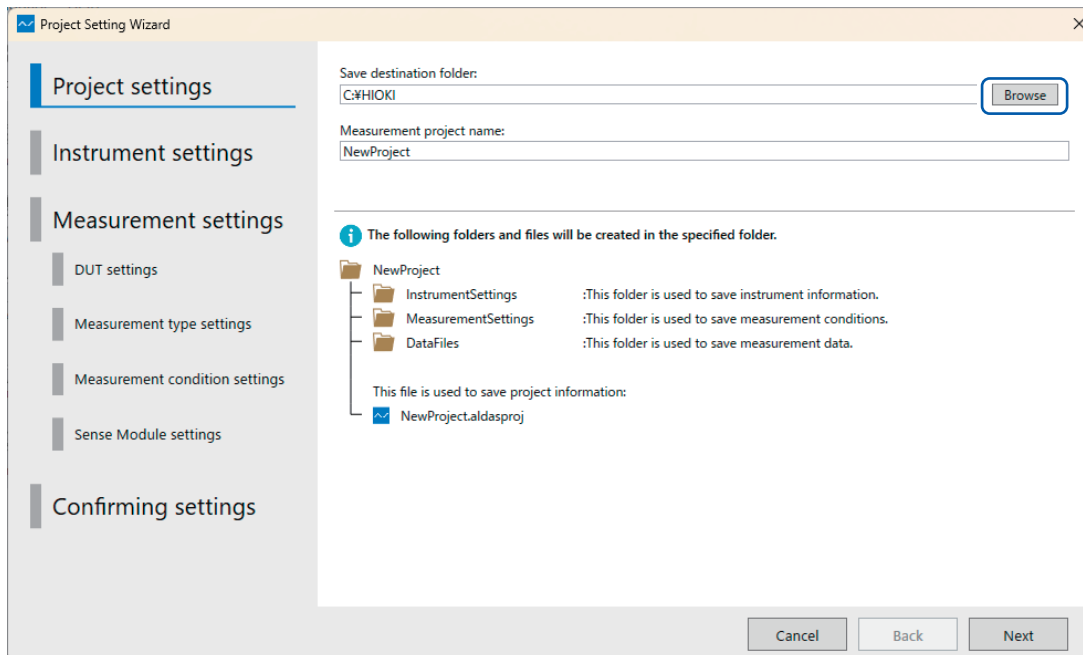

3 Click [Select Folder].

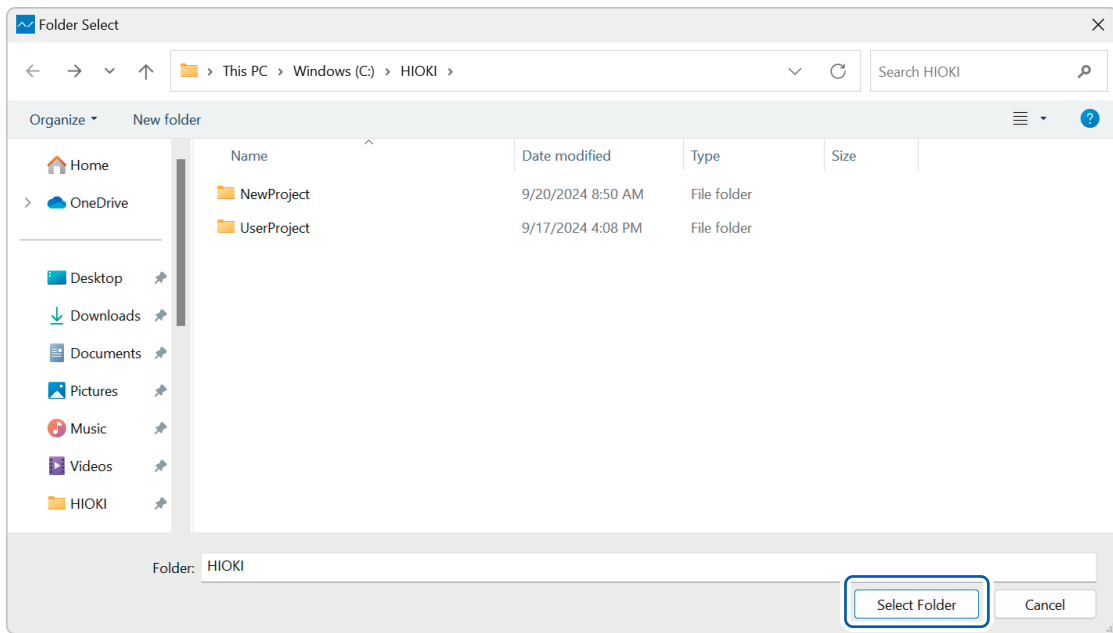

4 Specify the project name in the [Measurement project name] text box.

An error will be displayed if a project folder with the same name already exists in the specified directory. Specify a different name.

5 Click [Next].

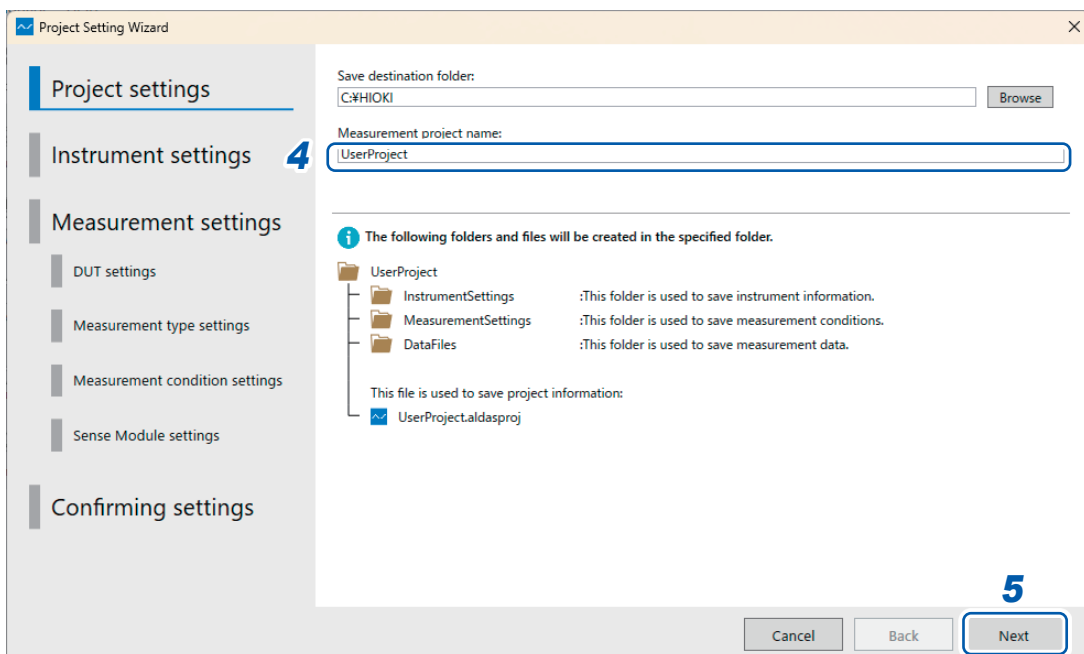

3.3 Connecting to the System Instruments

The PC environment needs to be set up to connect and communicate with the system instruments, which include the Sense Module (equipped with a current sensor and Sense Cables) and Source Module (equipped with a Source Cable, LAN hub, and LAN cables), that are involved in the measurement process.

If the initial configuration has been completed

A message indicating that the connection is successful will be displayed.

Click **[Next]** and proceed to “3.4 Setting the Measurement Method” (p.48).

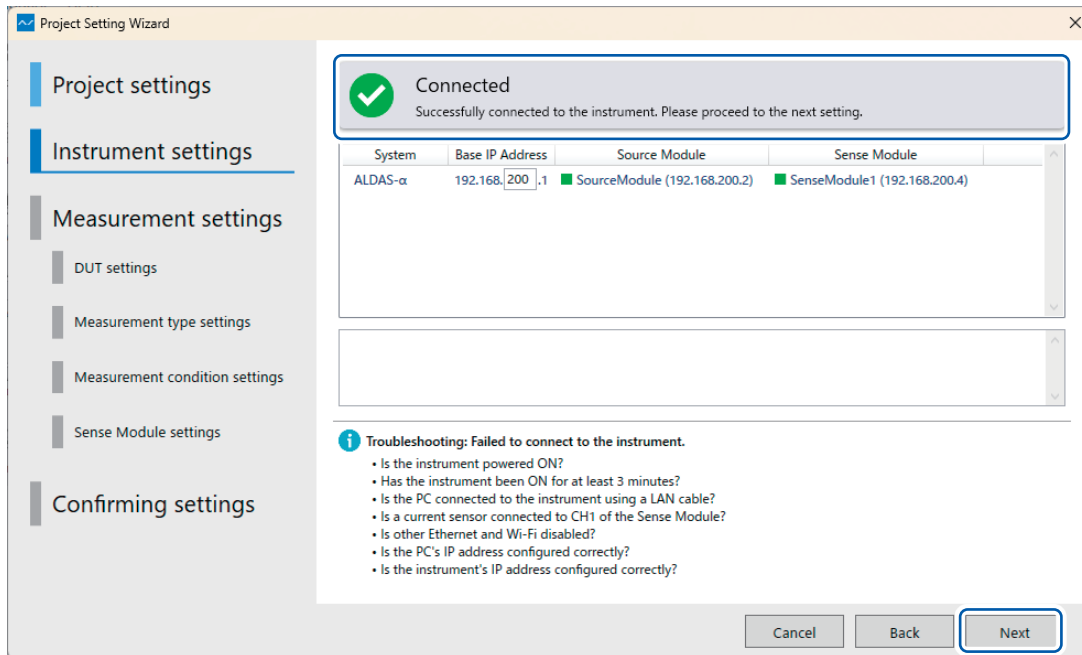

IMPORTANT

Please wait for at least 3 minutes after turning on the system to allow it to warm up before starting the measurement.

If the initial setup is incomplete

A message indicating that the PC application failed to connect to the measurement system will be displayed.

- 1 Check that both **Sense Module** and **Source Module** are turned on and connected to the PC via LAN cable. Then, click **[Not Connected]**.

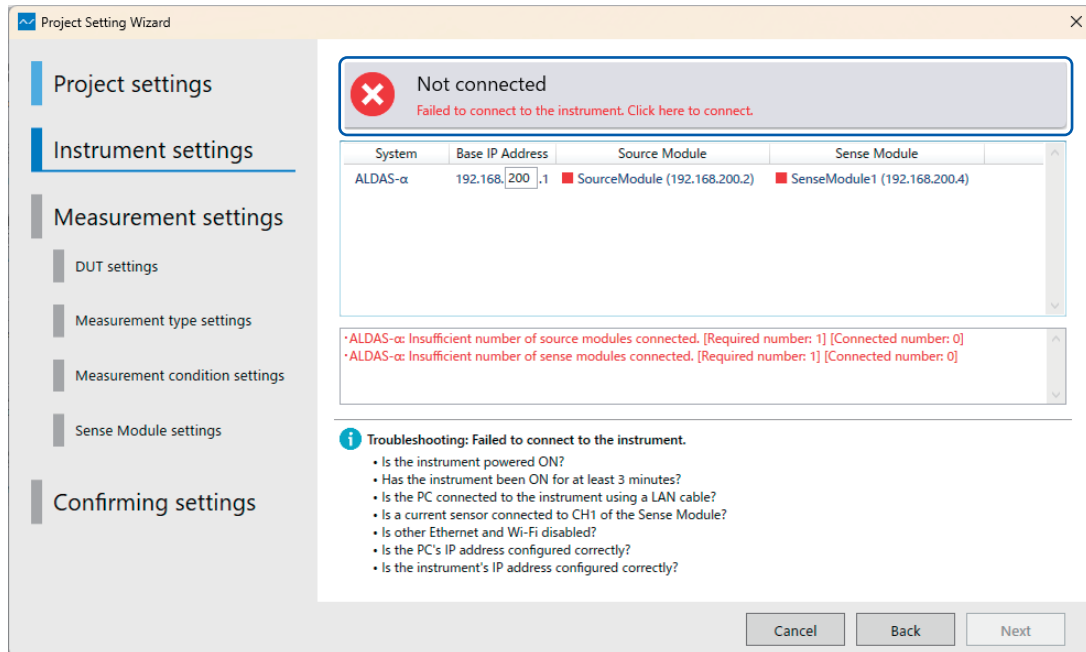

If the settings have been configured properly, a message indicating that the connection is successful will be displayed.

IMPORTANT

For trouble with the connections, please check the following troubleshooting points:

- Is the instrument powered ON?
- Has the instrument been ON for at least 3 minutes?
- Is the PC connected to the instrument using a LAN cable?
- Is a current sensor connected to CH1 of the Sense Module?
- Is the PC's IP address configured correctly?
- Is the instrument's IP address configured correctly?

3.4 Setting the Measurement Method

This section provides guidance on how to set types of measurements, measurement conditions, as well as settings for the Source and Sense Module.

Setting the measurement target (DUT)

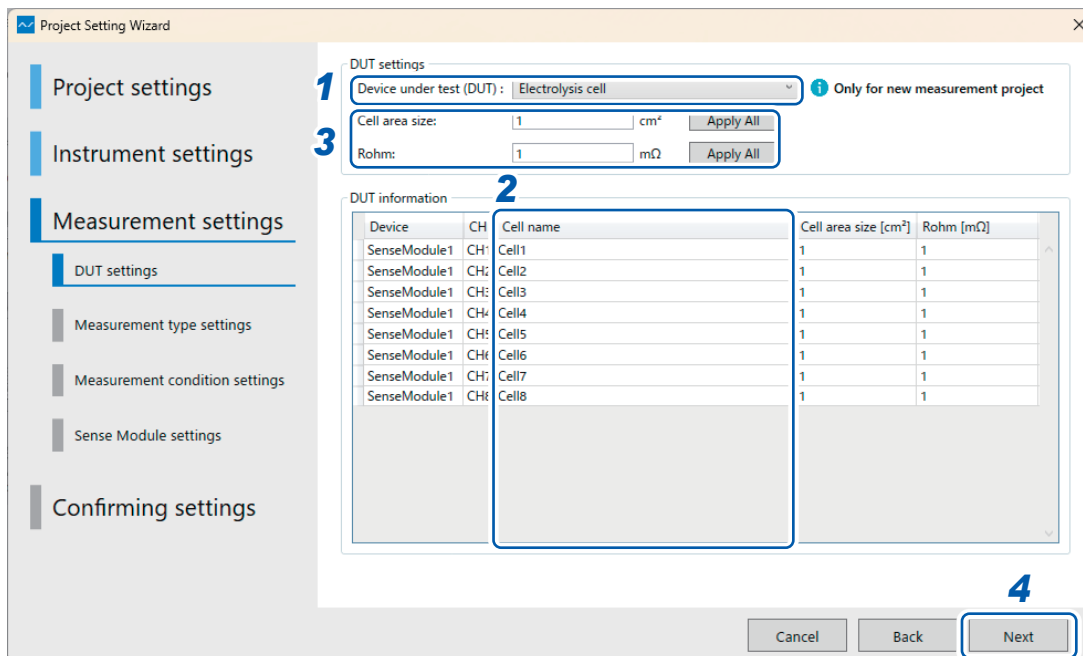

1 (When creating a new project file) Select **[Device under test (DUT)]**.

Electrolysis cell	EC: Electrolysis Cell
Fuel cell	FC: Fuel Cell

To change the measurement target (DUT), create a new project file.

2 Enter the name in **[Cell name]**.

The assigned name here will be shown in the graph legend. For the I-V graph, each cell name will have its own respective I-V plot. Multiple cells will result in multiple I-V curves on the same graph.

3 Enter values in **[Cell area size]** and **[Rohm]**.

Cell area size	By default, the cell size area size is set to “1”, but you can modify this value. The cell area size value is used to calculate the cell’s performance display in the I-V graph with current density. Specify “1”, which is the default value, in the following cases: <ul style="list-style-type: none"> • The current density display is not selected • The parameters are unknown • The parameter of the cell area size, etc. is not applicable to the measurement target
Rohm	Specifies the cell’s ohmic resistance. This value is used to calculate IRfree plots. If no value is specified, the default value is 1 mΩ.

4 Click **[Next]**.

The measurement method settings window will be displayed.

Setting the measurement method

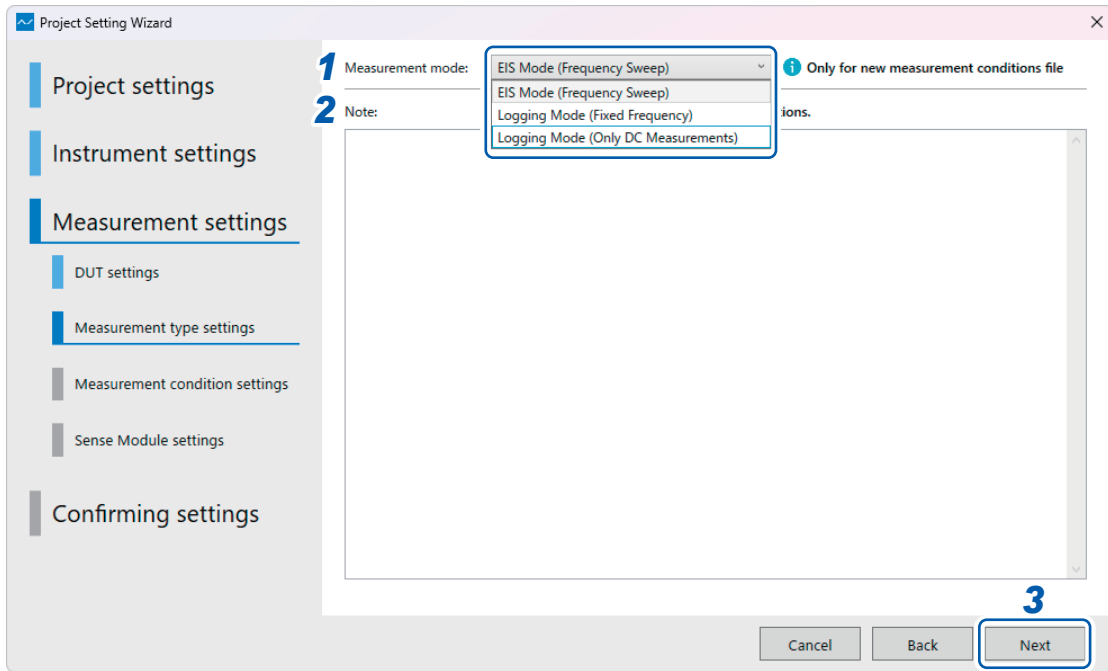

1 Select [Measurement mode].

IMPORTANT

If the PC goes into sleep mode during measurement, the measurement will stop. Please check your PC's power settings beforehand.

EIS Mode (Frequency Sweep)	Measures impedance while sweeping through a range of frequencies.
Logging Mode (Fixed Frequency)	Measures impedance continuously according to the specified frequency and measurement interval.
Logging Mode (Only DC Measurements)	Measures the DC voltage and current continuously according to the specified interval.

2 Enter any text in [Note].

You can enter and save the measurement conditions and other necessary notes as text and link them with the measurement data.

3 Click [Next].

The measurement conditions settings window will be displayed according to the measurement mode selected.

“Setting the EIS Mode measurement method” (p. 50)

“Setting the Logging Mode (Fixed Frequency) measurement method” (p. 53)

“Setting the Logging Mode (Only DC Measurements) measurement method” (p. 55)

Setting the EIS Mode measurement method

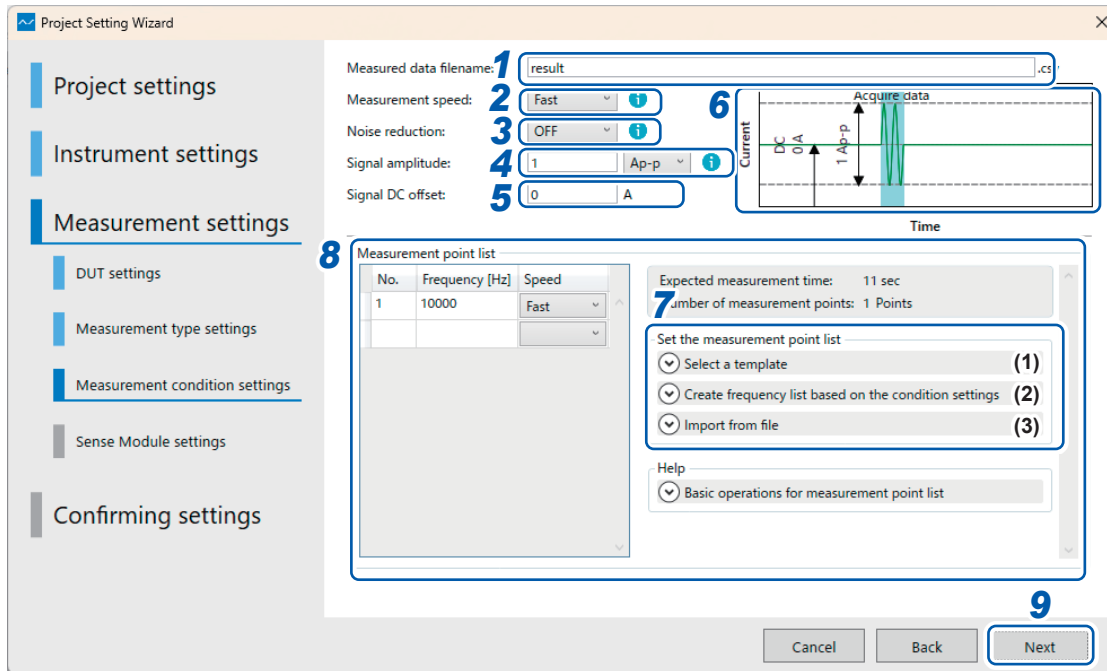

1 Specify the measurement results filename to save in the [Measured data filename] text box.

The results file will be saved in the [DataFiles] folder in the project folder. If a file with the same name already exists in the [DataFiles] folder, an incremented number will be appended to the end of the filename, for example [Filename_1.csv].

2 Select the measurement priority under [Measurement speed].

Fast	The measurement speed takes precedence over stability. This measurement speed yields the least stable results among all the others.
Medium	The measurement process ensures a balance between measurement speed and measurement stability.
Slow	Priority is given to the measurement stability when taking measurements. As the number of measurements increases, the measurement speed slows down compared to other modes.

3 Select the filter for suppressing noise under [Noise reduction].

OFF	Disables noise reduction.
ON	Reduces the noise generated at frequencies higher than the measurement signal frequency.

4 Specify the measurement signals' amplitude in the [Signal amplitude] text box.

The peak-to-peak or RMS current can be selected.

IMPORTANT

Set the measurement signal amplitude according to the measurement target specifications. Start with the amplitude value at around 5% of the measurement target DC current value. Setting the amplitude too small will result in an unstable impedance measurement. Setting the amplitude too large will cause the measurement target current to fluctuate significantly due to the applied measurement signal.

5 The DC offset setting depends on the type of DUT configuration:

EC or FC	To measure OCV, set to 0 A. Set the DC offset to the desired value between 0 and ± 20 A. The maximum ± 20 A also includes the peak value of the measurement signal I_{sig} . For EC, set the DC offset value to a value between 0 and +20 A. For FC, set the DC offset value to a value between -20 and 0 A.
EC + external DC power supply	Set the DC offset to 0 A. This value can be adjusted to apply a supplemental DC current to the DUT, in addition to the external DC power supply.
FC + external load	Set the DC offset to 0 A. This value can be adjusted to apply a supplemental load to the DUT, in addition to the external load.

6 The illustration shows the current measurement signal with the applied DC current.

The DC current arrow shows the position of the applied measurement signal to the DC current flow to the measurement target.

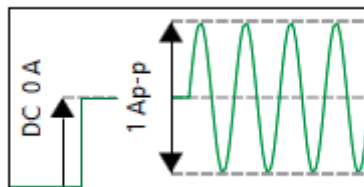

7 Select a method to generate the measurement signal's [Set the measurement point list] below:

(1) **[Select a template]**

Select frequency range template via drop down menu.
Conditions will be registered in the frequency list when they are selected from the combo box.

(2) **[Create frequency list based on condition settings]**

Generate the frequency list by specifying parameters such as start frequency, end frequency, and number of points. The conditions will be registered in the frequency list when the **[Create]** button is clicked after the settings have been configured.

(3) **[Import from file]**

Load the frequency list from a CSV file. When **[Browse]** is clicked and a file is selected, the measurement signal's frequencies will be loaded and registered in the frequency list. CSV files must satisfy the following conditions:

- Each frequency value must be separated by a newline codes.
- Frequency values must be within the range of 0.01 Hz to 100 kHz.
- Frequency values must have no more than two significant figures. (one significant figure for values between 0.01 and 0.1)

Example: 1200 Hz satisfies the conditions, but 1230 Hz does not.

If a value does not satisfy the conditions, it will be converted automatically to the nearest two significant figures value.

	A	B	C	D
1	10			
2	20			
3	30			
4	69			
5	80			
6	1000			

8 Edit [Measurement point list] (if necessary).

Perform measurement at the frequencies displayed in **[Measurement point list]**.
Double-click each number in the **[Frequency]** column to change the measurement signal frequency.
For more information about the resolution at which frequencies can be set, see “Impedance measurement frequency resolution” (p.104) in the specifications.
The **[Expected measurement time]** and **[Number of measurement points]** information will be displayed to the right of the list. Measurement time can vary depending on the measurement conditions. Use this information as a guide when creating conditions.
Noted that the maximum number of measurement points is 1000.

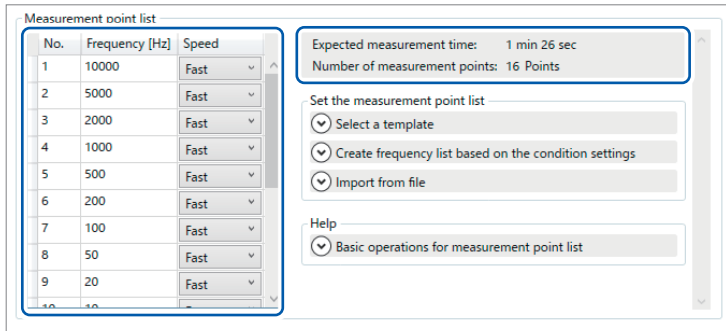

9 Click **[Next]**.

Proceed to “Configuring the Sense Module” (p.57).

Setting the Logging Mode (Fixed Frequency) measurement method

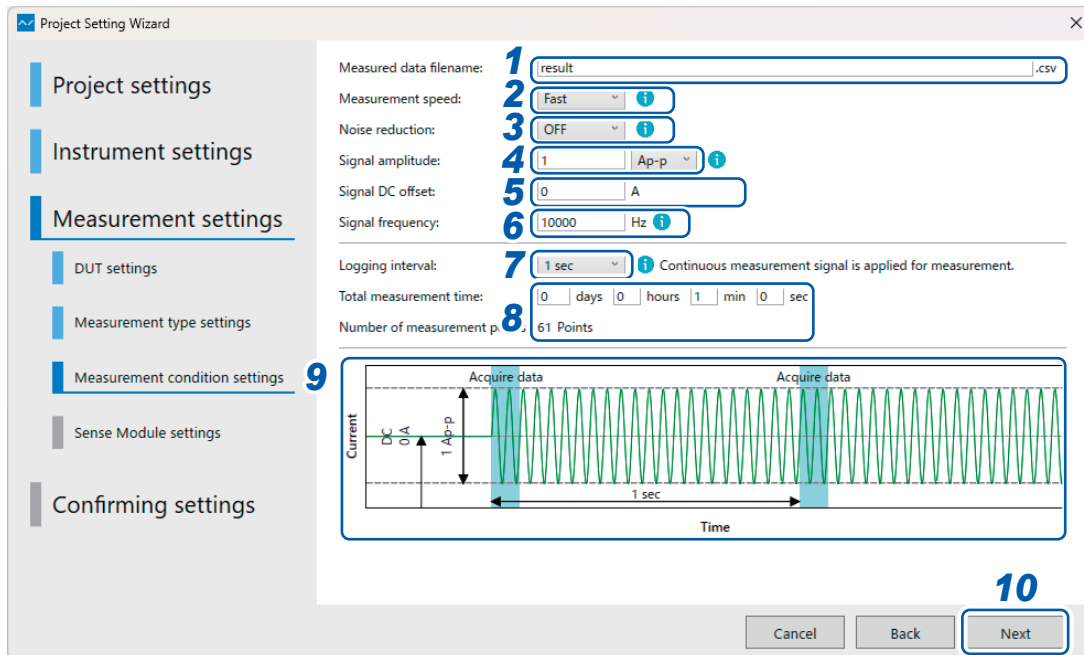

1 Specify the measurement results filename to save in the [Measured data filename] text box.

The results file will be saved in the [DataFiles] folder in the project folder. If a file with the same name already exists in the [DataFiles] folder, an incremented number will be appended to the end of the filename, for instance [Filename_1.csv].

2 Select measurement priority under [Measurement speed].

Fast	The measurement speed takes precedence over stability. This measurement speed yields the least stable results among all the others.
Medium	The measurement process ensures a balance between measurement speed and measurement stability.
Slow	Priority is given to the measurement stability when taking measurements. As the number of measurements increases, the measurement speed slows down compared to other modes.

3 Select the filter for suppressing noise under [Noise reduction].

OFF	Disables noise reduction.
ON	Reduces the noise generated at frequencies higher than the measurement signal frequency.

4 Specify the measurement signals' amplitude in the [Signal amplitude] text box.

The peak-to-peak or RMS current can be selected.

IMPORTANT

Set the measurement signal amplitude according to the measurement target specifications. Start with the amplitude value at around 5% of the measurement target DC current value. Setting the amplitude too small will result in an unstable impedance measurement. Setting the amplitude too large will cause the measurement target current to fluctuate significantly due to the applied measurement signal.

5 The DC offset setting depends on the type of DUT configuration:

EC or FC	To measure OCV, set to 0 A. Set the DC offset to the desired value between 0 and ± 20 A. The maximum ± 20 A also includes the peak value of the measurement signal I_{sig} . For EC, set the DC offset value to a value between 0 and +20 A. For FC, set the DC offset value to a value between -20 and 0 A.
EC + external DC power supply	Set the DC offset to 0 A. This value can be adjusted to apply a supplemental DC current to the DUT, in addition to the external DC power supply.
FC + external load	Set the DC offset to 0 A. This value can be adjusted to apply a supplemental load to the DUT, in addition to the external load.

6 Specify the measurement signal's frequency in the [Signal frequency] text box.

For more information about the resolution at which frequencies can be set, see "Impedance measurement frequency resolution" (p. 104) in the specifications.

7 Select the data acquisition interval under [Logging interval].

8 Specify the total time until measurement is stopped under [Total measurement time].

The [Number of measurement points] value during the interval will be automatically calculated from the [Logging interval] and the [Total measurement time] values. The maximum number of measurement points is 5000. Setting exceeding this value will be deemed invalid. Change the [Logging interval] or [Logging total time] setting so that the number of measurements is 5000 or less.

Total measurement time: days hours min sec
 Number of measurement points:

9 Check the measurement signal superposition with the DC waveform.

The illustration shows the measurement time sequence with time against current graph. The graph changes when the user inputs signal frequency, signal amplitude, logging interval, and speed. There are two ways the measurement signal can be applied: continuously or at discrete intervals. The system automatically selects the appropriate mode depending on the measurement parameters. The discrete measurement signal is applied when there is long intervals between measurement. The continuous measurement signal is applied when there is short intervals between the measurements. In this case, the DC voltage and DC current is recorded only at the beginning of the measurement.

10 Click [Next].

Proceed to "Configuring the Sense Module" (p.57).

Setting the Logging Mode (Only DC Measurements) measurement method

1 Specify the measurement results filename to save in the [Measured data filename] text box.

The results file will be saved in the [DataFiles] folder in the project folder. If a file with the same name already exists in the [DataFiles] folder, an incremented number will be appended to the end of the filename, for instance [Filename_1.csv].

2 Select measurement priority under [Measurement speed].

Fast	The measurement speed takes precedence over stability. This measurement speed yields the least stable results among all the others.
Medium	The measurement process ensures a balance between measurement speed and measurement stability.
Slow	Priority is given to the measurement stability when taking measurements. As the number of measurements increases, the measurement speed slows down compared to other modes.

3 Select the filter for suppressing noise under [Noise reduction].

OFF	Disables noise reduction.
ON	Reduces the noise generated at frequencies higher than the measurement signal frequency.

4 The DC offset setting depends on the type of DUT configuration:

EC or FC	To measure OCV, set to 0 A. Set the DC offset to the desired value between 0 and ± 20 A. The maximum ± 20 A also includes the peak value of the measurement signal I_{sig} . For EC, set the DC offset value to a value between 0 and +20 A. For FC, set the DC offset value to a value between -20 and 0 A.
EC + external DC power supply	Set the DC offset to 0 A. This value can be adjusted to apply a supplemental DC current to the DUT, in addition to the external DC power supply.
FC + external load	Set the DC offset to 0 A. This value can be adjusted to apply a supplemental load to the DUT, in addition to the external load.

5 Select the data acquisition interval under [Logging interval].

6 Specify the total time until measurement is stopped under [Total measurement time].

The [Number of measurement points] value during the interval will be automatically calculated from the [Logging interval] and the [Total measurement time] values.
The maximum number of measurement points is 5000. Setting exceeding this value will be deemed invalid.
Change the [Logging interval] or [Logging total time] setting so that the number of measurements is 5000 or less.

Total measurement time:	<input type="text" value="0"/> days	<input type="text" value="0"/> hours	<input type="text" value="1"/> min	<input type="text" value="0"/> sec
Number of measurement points	<input type="text" value="61 Points"/>			

7 Click [Next].

Proceed to “Configuring the Sense Module” (p.57).

Configuring the Sense Module

A Sense Module settings screen will be displayed according to the type of Sense Module model number.

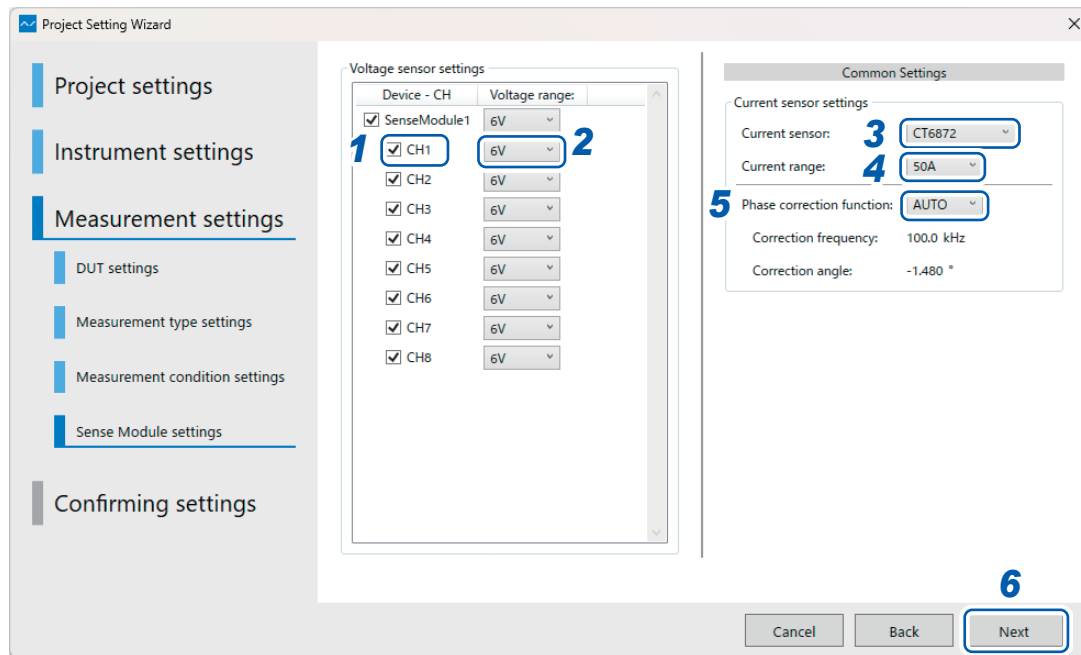

1 Select [Device - CH] checkboxes.

Select the desired channels for measurement. Only channels with a checked box will be included. The default setting selects all the check boxes. Please deselect the check box for the channels that are not used for measurement.

2 Set each channel's range under [Voltage range].

The voltage range must be set larger than the measurement target's load voltage.

3 Verify that the model name displayed in [Current Sensor] matches the model name of the connected current sensor.

See "2.4 Connecting the Current Sensor (Current Input)" (p.31).

4 Specify the current range of the current sensor used to measure impedance under [Current range].

The current range must be set larger than the measurement target's total current.

5 Select the phase correction function under [Phase correction function].

There are two types of phase correction functions:

AUTO	Performs phase correction using the correction values registered for each sensor.
OFF	Does not perform phase correction.

6 Click [Next].

Proceed to "Review measurement settings" (p.58).

Review measurement settings

Review the project, instrument, and measurement settings.

Click **[Complete]** to finish the measurement setup.

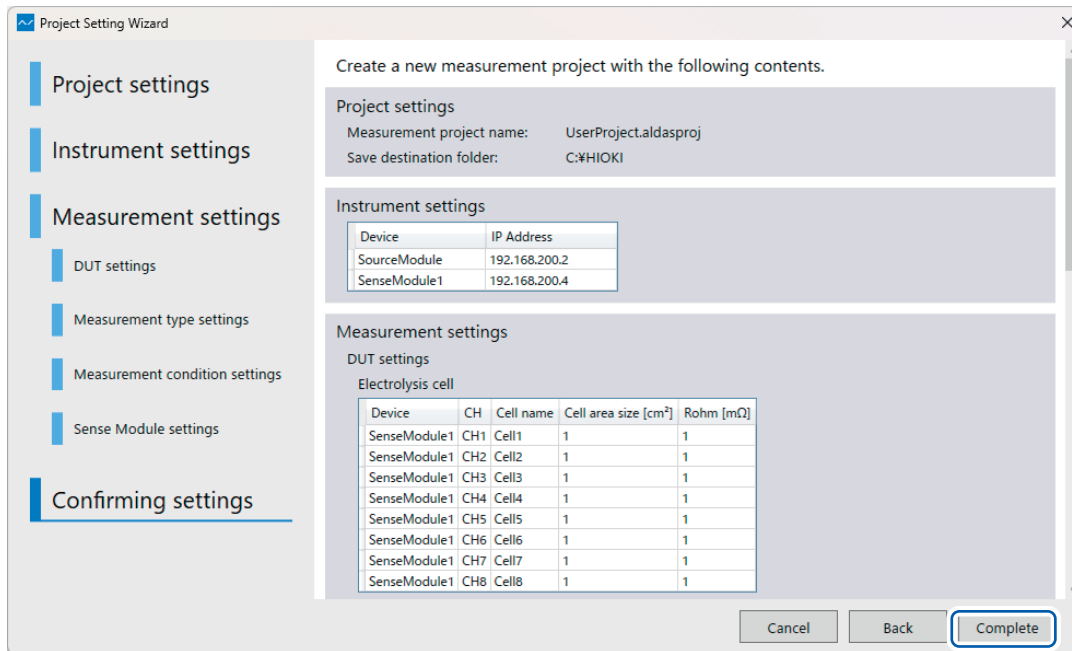





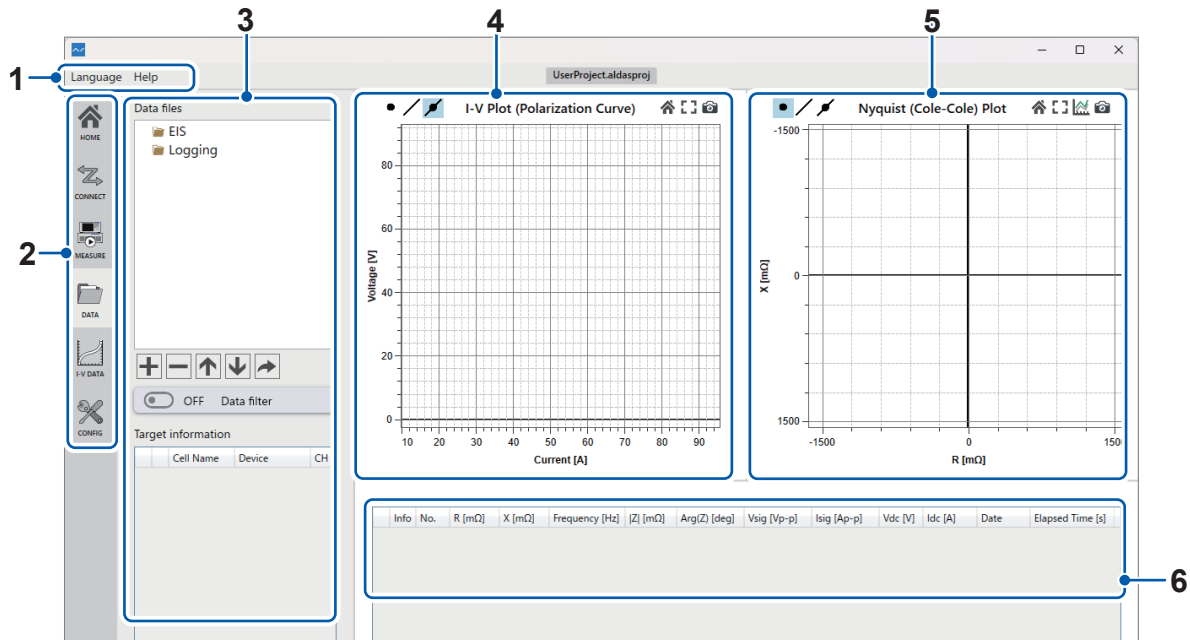

3.5 Main Application Window Overview

The main application window will be displayed after completing the measurement setup.



3

Configuring the PC Application

1	Menu bar	Language	The application language can be changed and selected here.	
		Help	The Help menu contains the application information and the instruction manual.	
2	Tab list		Home	Displays windows to create, save, and open project files.
			Connection settings	Displays a [Connection status] button.
			Measurement settings	Displays a list of measurement condition files, measurement start and stop buttons, and measurement progress.
			Measurement data	Displays a list of data files.
			I-V data	Displays a list of I-V data.
			Configuration settings	Display graph and data table settings.
3	Side menu	Displays settings for the function selected in the tab list.		
4	I-V graph	Displays the relationship between current (or current density) and voltage.		
5	Impedance graph	Displays impedance graph, either Nyquist (Cole-Cole) or Bode plot.		
6	Data table	Displays detailed measurement data from the selected file in a table.		

3.6 Measurement Project Files and Folders

Verify that the following folders and files have been generated in the directory specified in “3.2 Creating a Measurement Project” (p.44):

[Specified project name] directory

- [DataFiles] directory
- [InstrumentSettings] directory
- [MeasurementSettings] directory
- [Specified project name] ALDAS Project File

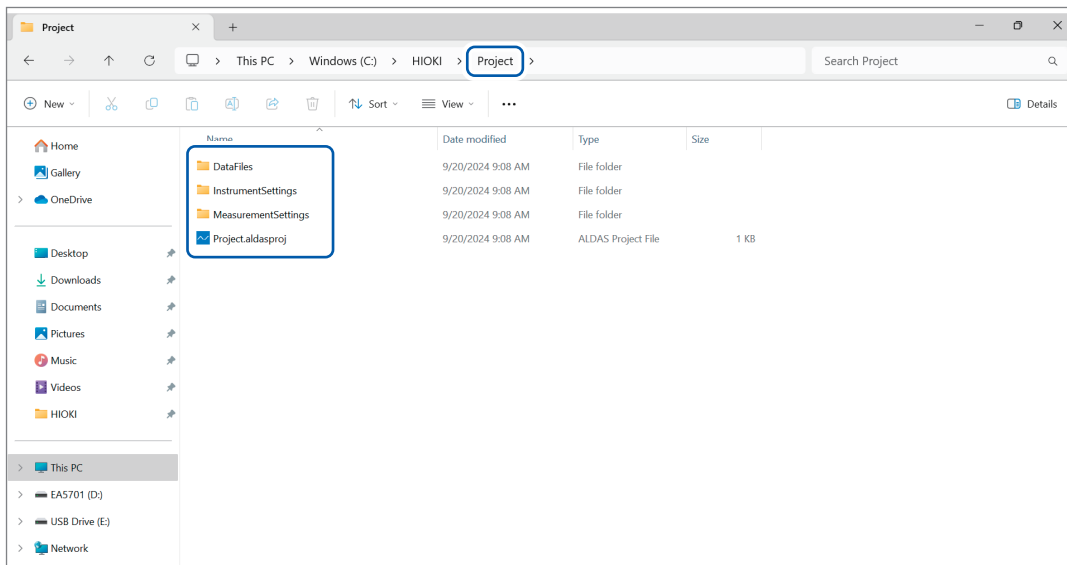

4 Making Measurements

4.1 Starting Measurement

- 1 Click the Measurement settings ([MEASURE]) tab.

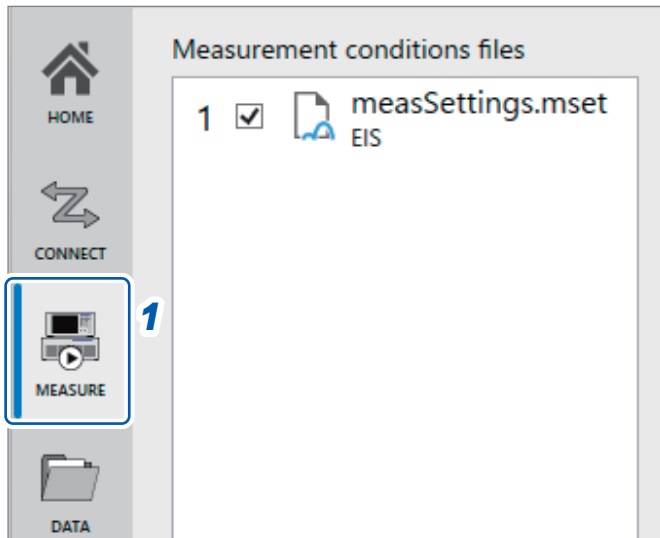

- 2 Click [Start].

Measurement will start using the set conditions.

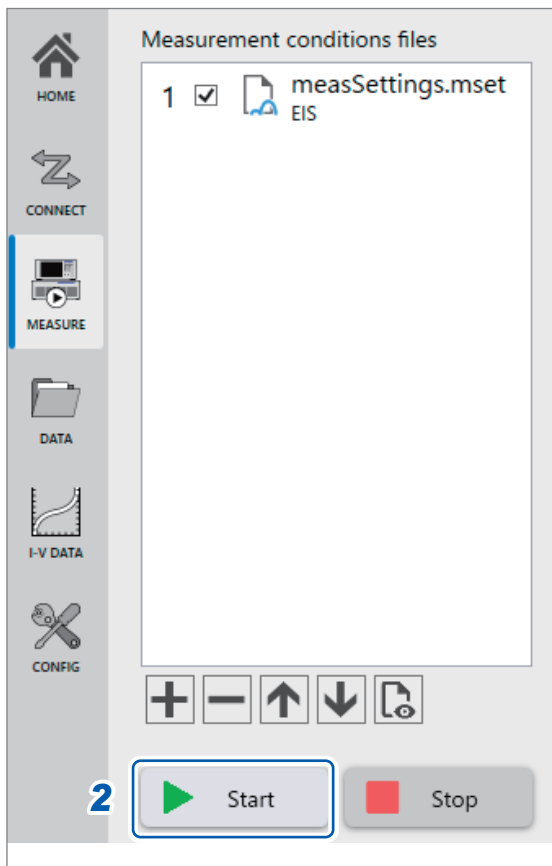

Starting Measurement

The main window will automatically switch to the Measurement data (**[DATA]**) tab. Measured data will automatically be added to the graph. In addition, measured data will be sequentially saved in CSV format in the **[DataFiles]** folder in the project folder. See “3.6 Measurement Project Files and Folders” (p.60) for more details.

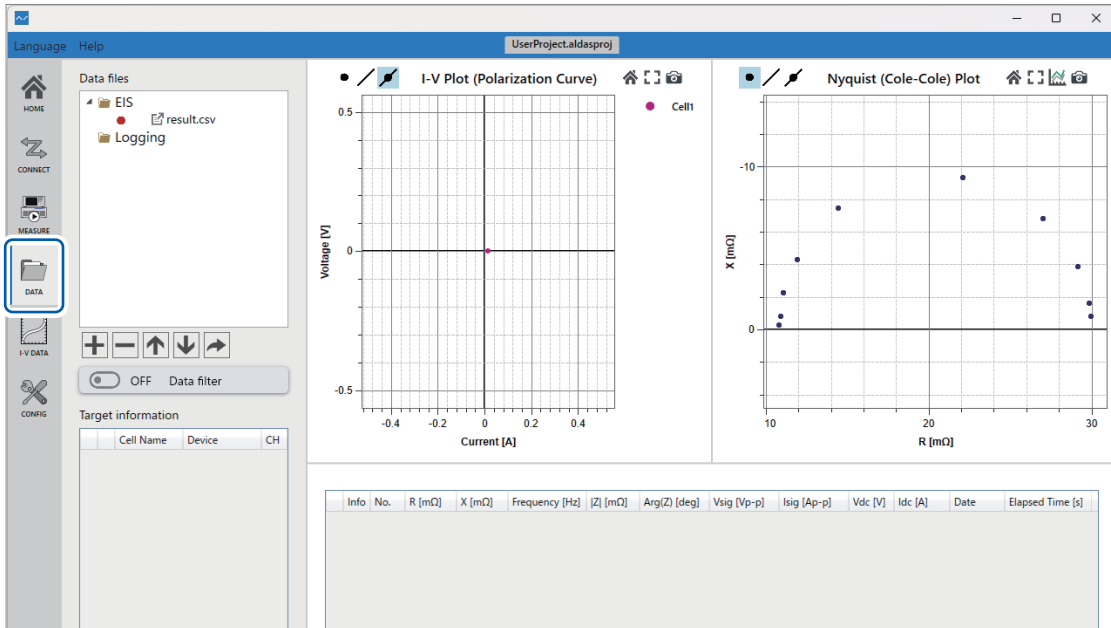

4.2 Checking Conditions During Measurement

To view the measurement progress, open the **[MEASURE]** tab and find it under **[Measurement status]** in the side menu.

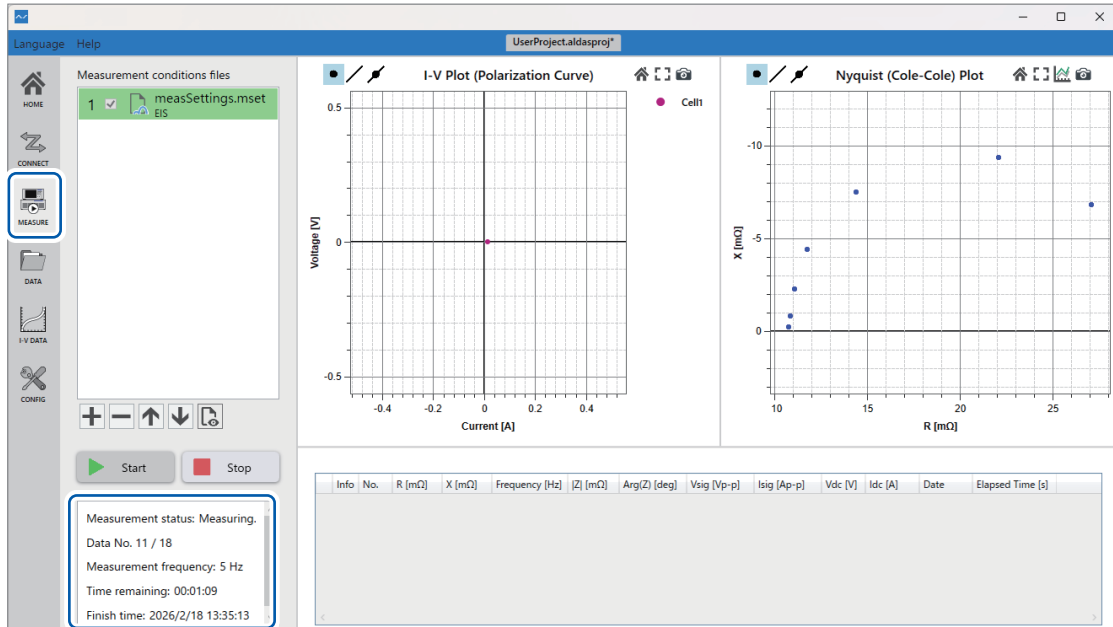

4.3 Stopping Measurement

Measurement will stop automatically once the final data point for the measurement condition file is acquired.

To stop the measurement in progress, follow the procedure below:

- 1 Click the Measurement settings ([MEASURE]) tab.
- 2 Click [Stop], and the top menu blue bar will disappear and restore to default view.

The screenshot shows the software interface with the 'MEASURE' tab selected in the left sidebar. The main area displays two plots: an 'I-V Plot (Polarization Curve)' and a 'Nyquist (Cole-Cole) Plot'. The 'Stop' button is highlighted with a red box and a blue '2'. The 'MEASURE' button in the sidebar is highlighted with a blue '1'. Below the plots, there is a table with the following columns:

Info	No.	R [mΩ]	X [mΩ]	Frequency [Hz]	Z [mΩ]	Arg(Z) [deg]	Vsig [Vp-p]	Isig [Ap-p]	Vdc [V]	Idc [A]	Date	Elapsed Time [s]

Below the table, the measurement status is displayed:

Measurement status: Measuring.
 Data No. 11 / 18
 Measurement frequency: 5 Hz
 Time remaining: 00:01:09
 Finish time: 2026/2/18 13:35:13

4.4 Measuring continuously (When There Are Multiple Measurement Conditions)

1 Click the Measurement settings ([MEASURE]) tab.

2 Edit the list of the [Measurement conditions files].

If multiple measurement conditions are listed in the [Measurement conditions files], the measurements are conducted in order from top to bottom for the conditions with checked boxes.

For more information about the use of the measurement condition files, see “7.2 Manipulating Measurement Conditions Files” (p.87).

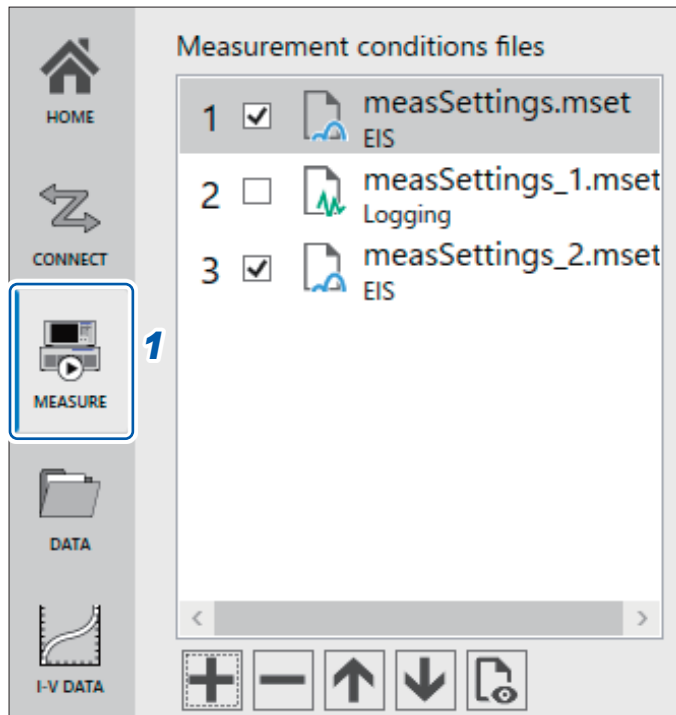

5

Checking Impedance Measurement Results

5.1 Viewing Data Files

1 Click the Measurement data ([DATA]) tab.

2 From the [Data files] list, select the desired data file.

There are two categories of data file: [EIS] and [Logging]. The impedance graph will change according to the types of data category file selected.

Information for each measured channels will be displayed under [Target information].

3 Select a target from [Target information].

Measurement data for the selected channel will be displayed in the data table at the bottom right of the window. Use the table to check impedance and other measured values for each frequency.

The next page displays the detailed information for each item in the data table.

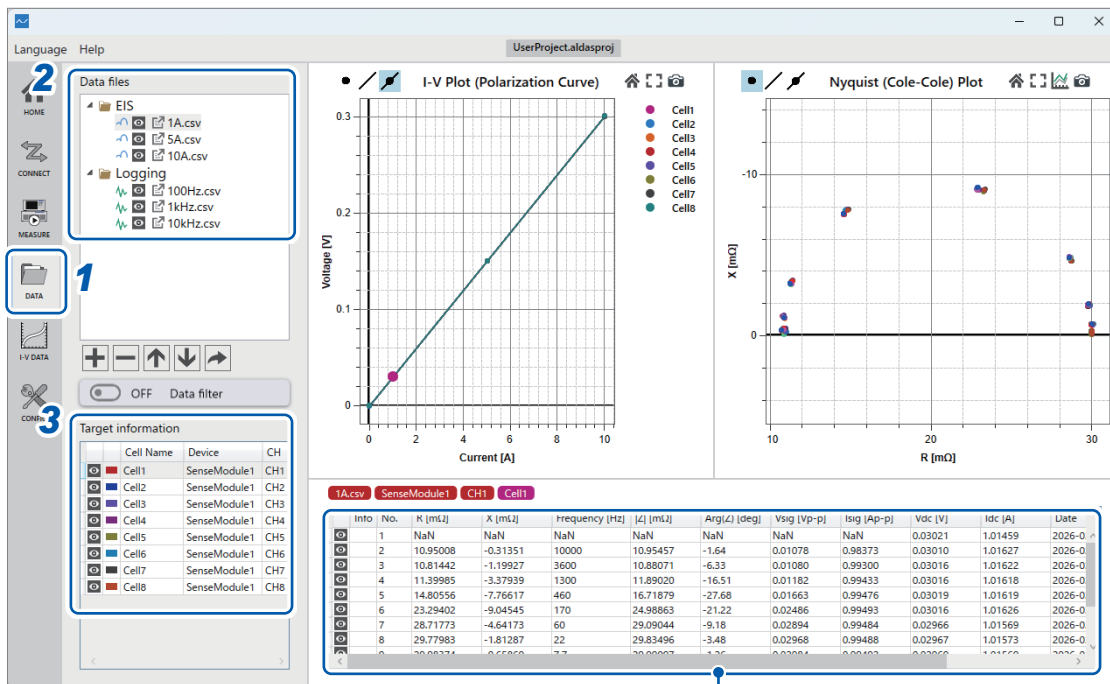

Data table

5

Data table explanation

1	2	3	4	5	6	7	8	9	10
Info	No.	R [mΩ]	X [mΩ]	Frequency [Hz]	Z [mΩ]	Arg(Z) [deg]	Vsig [Vp-p]	Isig [Ap-p]	
<input checked="" type="checkbox"/>	1	30.46791	-0.96405	10	30.48315	-1.81	0.30313	9.94423	
<input checked="" type="checkbox"/>	2	30.29769	-2.07850	22	30.36890	-3.92	0.30158	9.93047	
<input checked="" type="checkbox"/>	3	29.71325	-4.17966	46	30.00578	-8.01	0.29634	9.87605	
<input checked="" type="checkbox"/>	4	27.46922	-8.17431	100	28.65968	-16.57	0.27687	9.66078	

11	12	13	14
Date	Elapsed Time [s]	Vdc [V]	Idc [A]
2024-09-18 09:59:01	7.3	0.611	19.959
2024-09-18 09:59:08	14.5	0.611	19.958
2024-09-18 09:59:15	21.7	0.611	19.957
2024-09-18 09:59:23	25.1	0.611	19.957

No.	Item	Description
1		Selects whether to display the corresponding data in the graph. Data whose <input checked="" type="checkbox"/> mark is selected will be shown in the graph, while data whose <input type="checkbox"/> mark is not selected will not be shown in the graph.
2	Info	A warning icon will be displayed if the measured value is abnormal or if there is an error with the measurement conditions. Hover over the icon to see the reason. A warning example is listed below: <ul style="list-style-type: none"> • The measured value contains a non-numeric value (NaN). • The measured values contain infinity values (∞). • A small value of Vsig could lead to a significant measurement error. • Isig is very small compared to the set value. • The real part of the impedance has a negative value.
3	No.	This is the sequence number assigned to each data point as it is collected.
4	R [mΩ]	Real part of the impedance.
5	X [mΩ]	Imaginary part of the impedance.
6	Frequency [Hz]	Frequency at which impedance was measured.
7	Z [mΩ]	Absolute value of the impedance.
8	Arg(Z) [deg]	Phase angle of the impedance.
9	Vsig [Vp-p]	Peak-to-peak of signal's voltage amplitude at the impedance measurement frequency.
10	Isig [Ap-p]	Peak-to-peak of signal's current amplitude at the impedance measurement frequency.
11	Date	The time and date of data acquisition.
12	Elapsed Time [s]	Total time that has passed since the measurement begin.
13	Vdc [V]	Measured DC voltage.
14	Idc [A]	Measured DC current.

Access the measurement conditions for each data file by clicking the measurement condition button beside the file name.

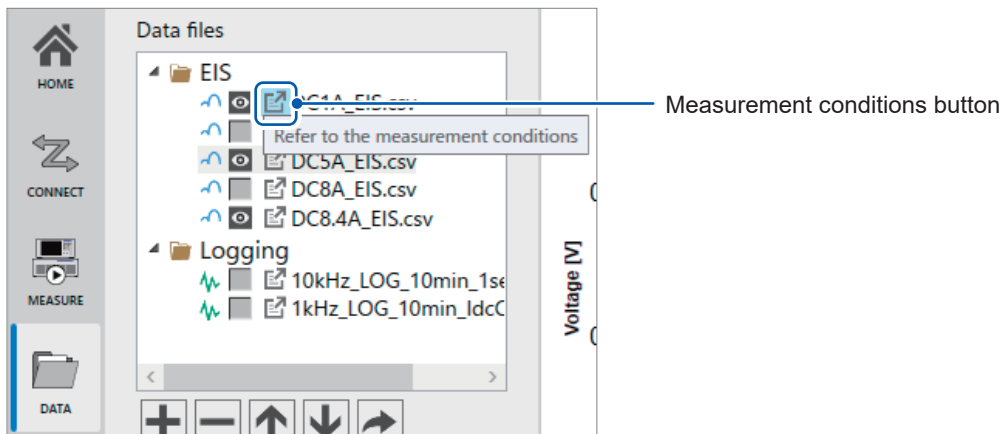

View each setting by clicking the tabs on the left. Please note that these conditions are view-only and cannot be edited.

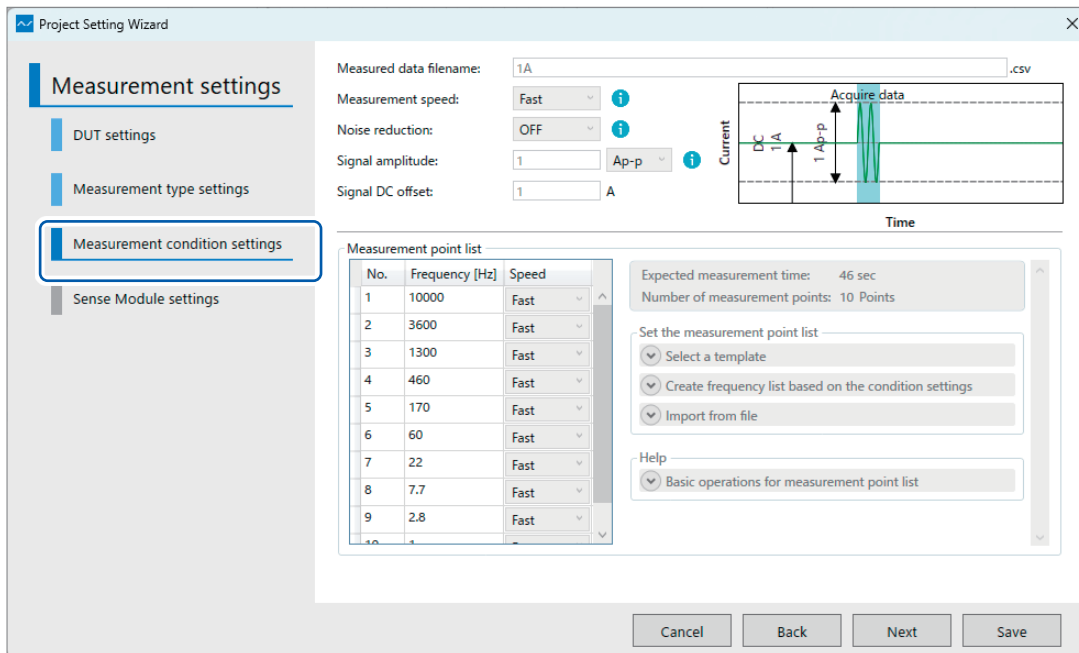

See “Setting the measurement target (DUT)” (p.48), “Setting the EIS Mode measurement method” (p.50), “Setting the Logging Mode (Fixed Frequency) measurement method” (p.53), “Configuring the Sense Module” (p.57), and “Review measurement settings” (p.58).

Clicking on the **[Measurement type settings]** tab displays a screen that includes a measurement condition memo text box.

Enter a memo during measurement here. The memo will be saved together with the measurement data file.

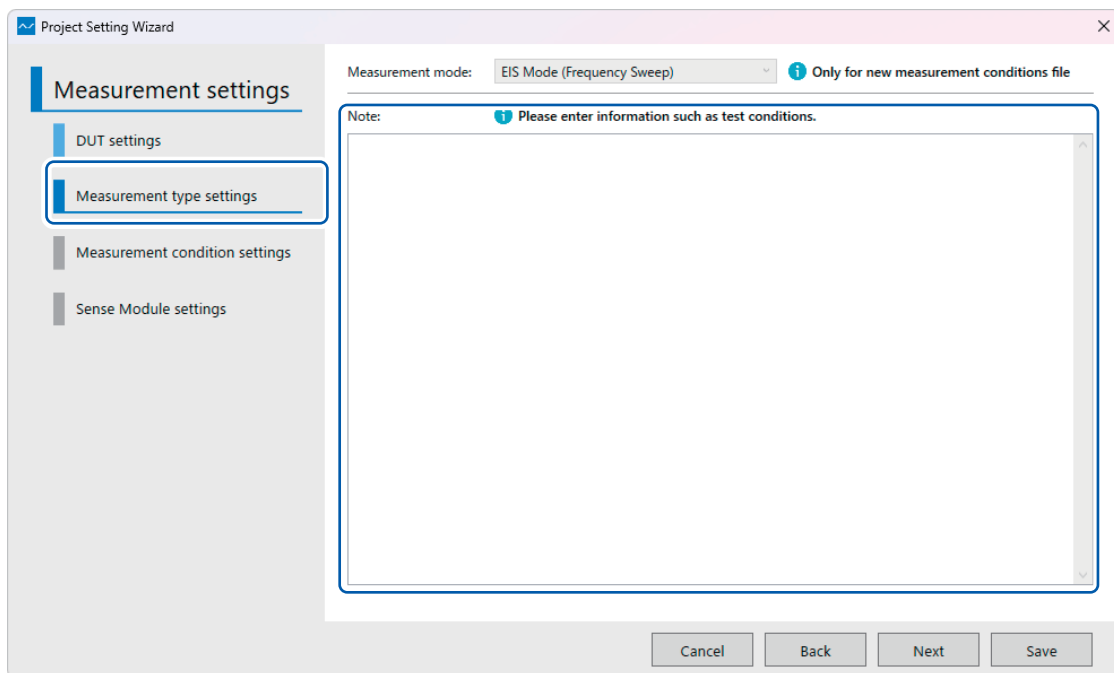

5.2 Changing the Graph's Configuration Settings

- 1 Click the Configuration settings ([CONFIG]) tab.

Graph's configuration setting will be displayed.

- 2 Change the impedance graph's configuration settings.

For [EIS] category data file:

For [Logging] category data file:

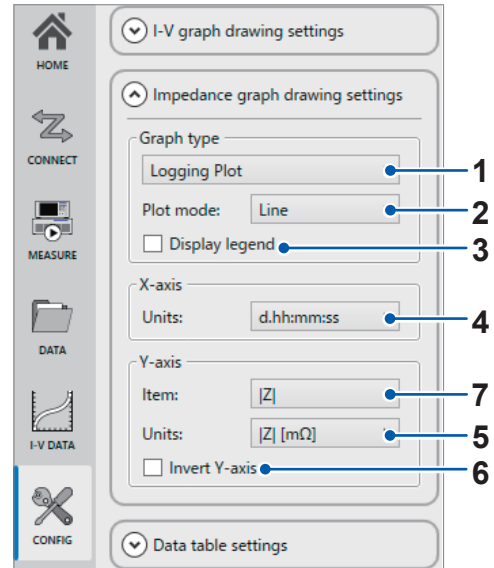
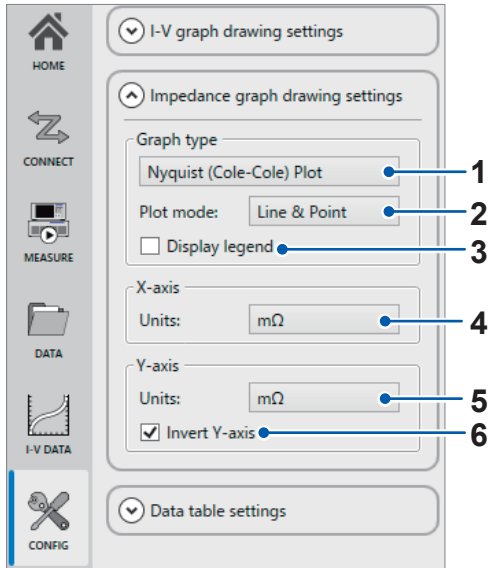

No.	Item	Description
1	Graph type	The following graph types are available for each category. For [EIS] category: <ul style="list-style-type: none"> • Nyquist (Cole-Cole) Plot • Bode Plot For [Logging] category: <ul style="list-style-type: none"> • Logging Plot
2	Plot mode	Set the plot mode to Point, Line, or Line & Point.
3	Display legend	The graph legend can be displayed or hidden.
4	X-axis Units	Select the unit prefix for the X-axis to change the scale of the graph.
5	Y-axis Units	Select the unit prefix for the Y-axis to change the scale of the graph.
6	Invert Y-axis	Positive and negative directions for the Y-axis can be inverted for better visualization purposes.
7	Y-axis Item	Select the Y-axis item from the drop-down menu. The available items depend on the selected graph type.

5.3 Manipulating Data Filters

Use the data filter function to search for measured data that satisfies certain conditions.

1 Click the Measurement data ([DATA]) tab.

2 Click [Data filter].

The data selection window will be displayed.

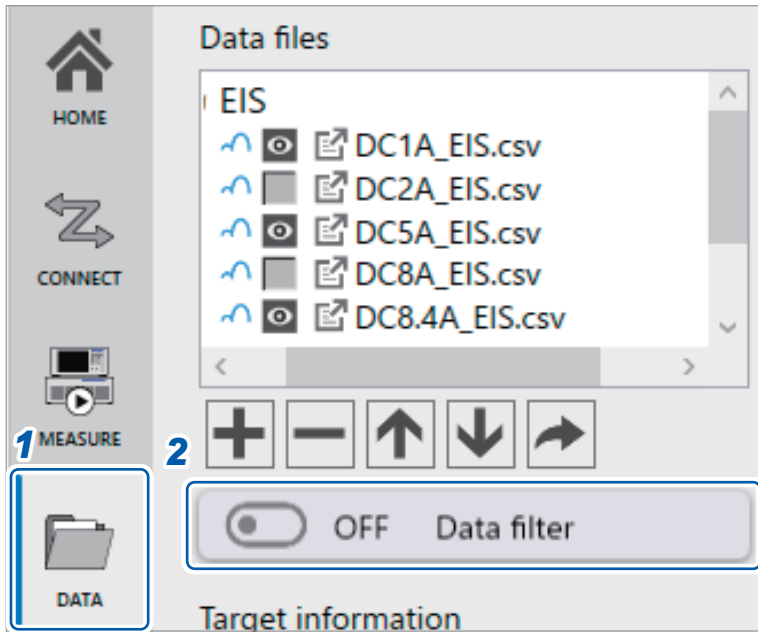

- 3 Select [Data type].
- 4 Select detailed search conditions and enter a keyword or value.
Selecting multiple parameters will apply an AND condition.
- 5 Click [OK].

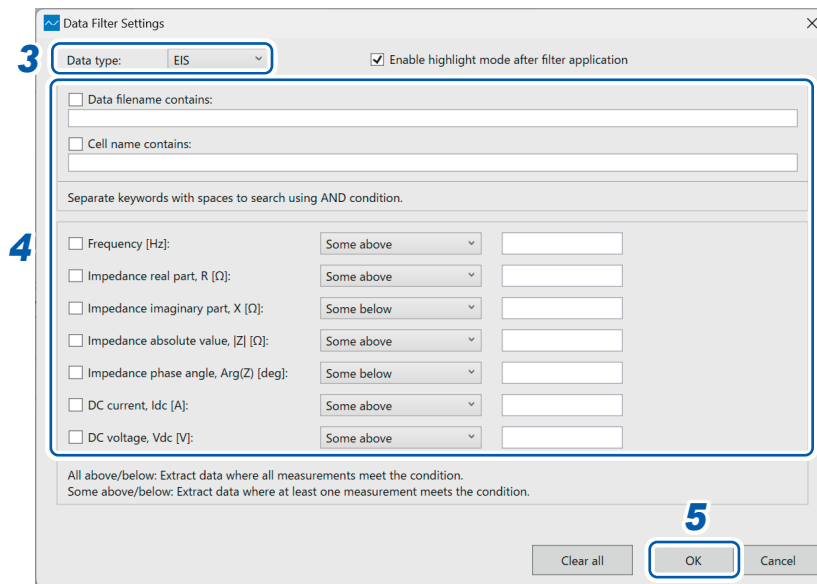

Measurement targets that satisfy the specified conditions will be displayed in the [Target information] table. If the [Enable highlight mode after filter application] checkbox is selected, only the measurement targets that match the filter will be highlighted and displayed in the graph.

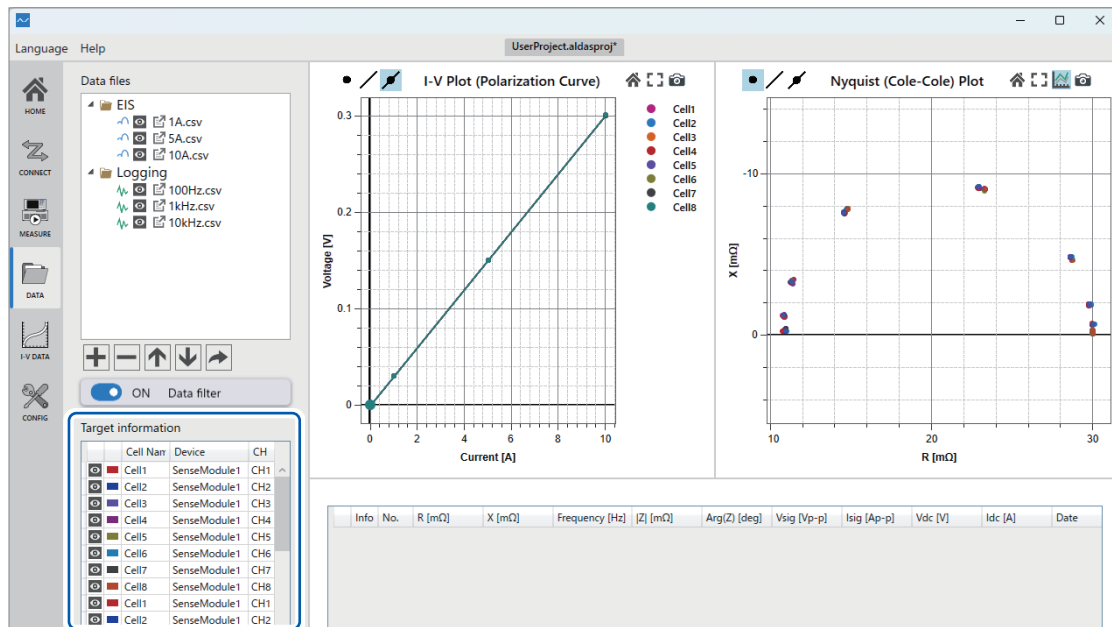

6

I-V Graph Function

This software generates an I-V graph based on the measured DC current and voltage DC values. The I-V graph is displayed alongside the impedance graph for easy comparison. An IR-free graph can also be generated by entering the cell's ohmic resistance in the cell information.

6.1 Displaying I-V Data

- 1 Click the I-V data ([I-V DATA]) tab.
- 2 Select the [Display I-V graph] checkbox.

You can display or hide the graph by selecting or deselecting the checkbox.

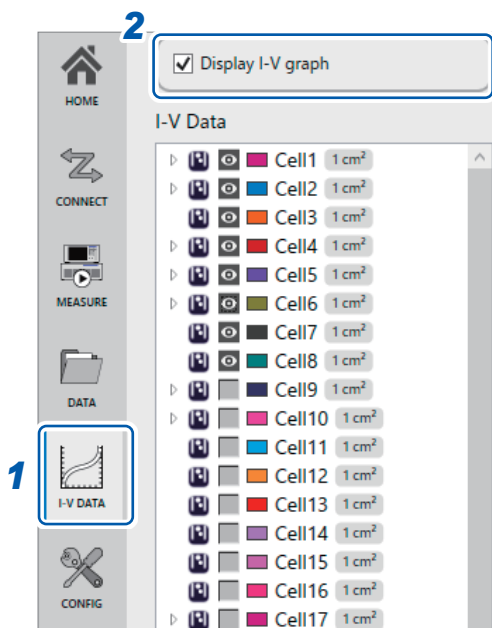

The I-V graph is displayed on the left side of the impedance graph.

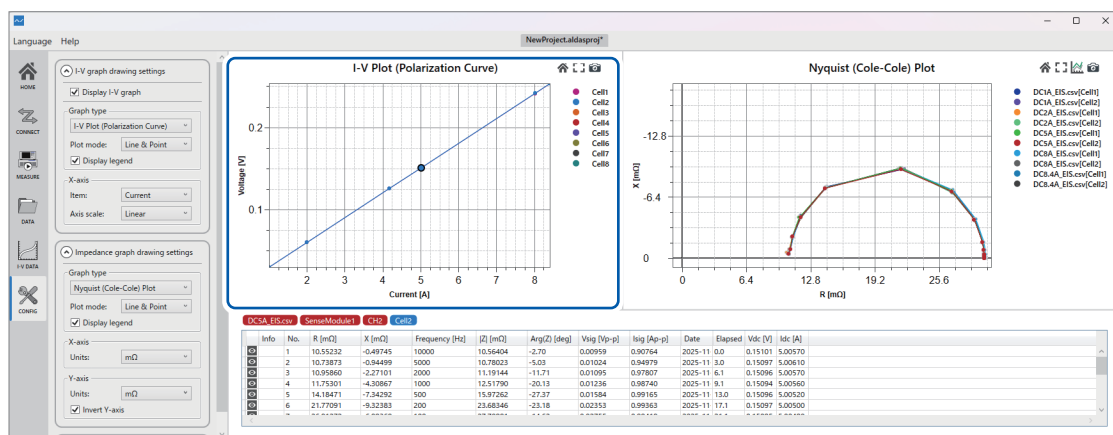

6.2 Changing the I-V Graph Settings

- 1 Click the Configuration settings ([CONFIG]) tab.
- 2 Change [I-V graph drawing settings].

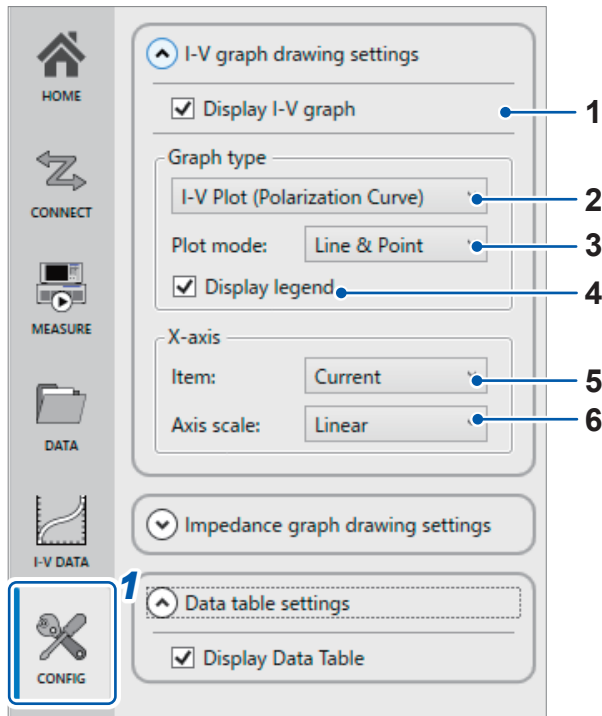

No.	Item	Description
1	Display I-V graph	Show or hide the I-V graph.
2	Graph type	The following graph types are available for selection: <ul style="list-style-type: none"> • I-V Plot • IR-free Plot • I-Power Plot • I-Impedance Plot
3	Plot mode	Set the plot mode to Point, Line, or Line & Point.
4	Display legend	The graph legend can be displayed or hidden.
5	X-axis Item	Set the X-axis parameter to either Current or Current Density.
6	X-axis Axis scale	Select either linear or logarithmic scale for the X-axis.

IR-free Plot

Plots the values calculated using the following formula and the user-specified ohmic resistance value as the [IR-free Voltage] value on the vertical axis.

$$\text{IR-free Voltage} = V_{dc} - R_{ohm} \times I_{dc}$$

V_{dc} : DC voltage of the measurement target

I_{dc} : DC current of the measurement target

R_{ohm} : Ohmic resistance specified by the user in cell information

I-Power Plot

Plots the values calculated using the following formula from the measurement data as the **[Power]** value on the vertical axis.

$$\text{Power} = V_{dc} \times I_{dc}$$

V_{dc}: DC voltage from the measurement data for the corresponding channel

I_{dc}: DC current from the measurement data for the corresponding channel

I-Impedance Plot

Plots the following measured values as the **[R_{hf}]** or **[R_{lf}]** value on the vertical axis:

These values can be changed using the operations described in “6.3 Editing I-V Data” (p.78).

R_{hf}: Impedance real part at the highest frequency in the measurement data for the corresponding channel

R_{lf}: Impedance real part at the lowest frequency in the measurement data for the corresponding channel

6.3 Editing I-V Data

Editing Cell Information

- 1** Click the I-V data ([I-V DATA]) tab.
- 2** Right-click on the cell information you wish to edit in the [I-V Data] list, and then select [Edit cell information].

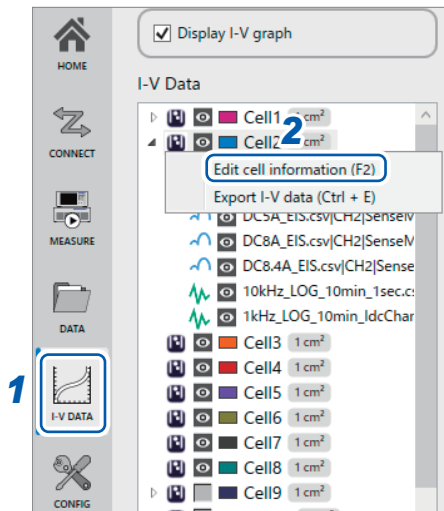

The cell information editing window will be displayed.
 The cell information set in “Setting the measurement target (DUT)” (p.48) is displayed in this window.

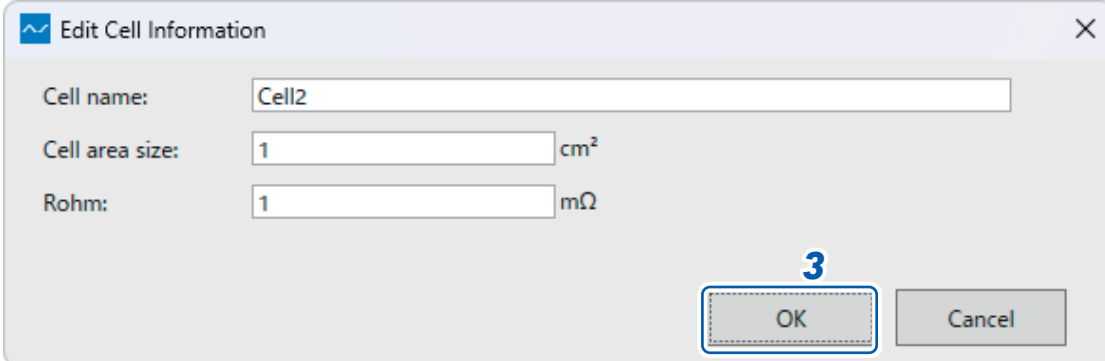

Cell name	You can change the name of the cell displayed on the graph legend and other locations.
Cell area size	By default, the cell size area size is set to “1”, but this value can be modified. This value is used to calculate current density. The default value “1” applies in the following cases: <ul style="list-style-type: none"> • The current density display is not selected • The parameters are unknown • The parameter of the cell area size, etc. is not applicable to the measurement target
Rohm	Specifies the cell’s ohmic resistance. This value is used to calculate IR-free plots. If no value is specified, the default value is 1 mΩ.

- 3** Edit the cell information and click [OK].
 The edited information will be applied to the display results.

Editing the I-V information

- 1 Click the I-V data ([I-V DATA]) tab.
- 2 Right-click on the I-V information you wish to edit in the [I-V Data] list, and then select [Edit I-V information].

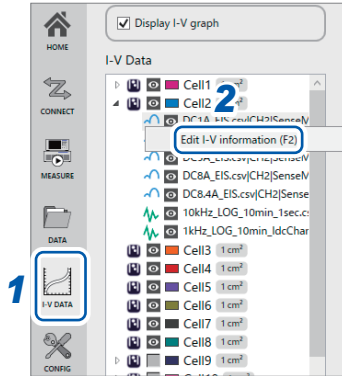

The I-V information editing window will be displayed.

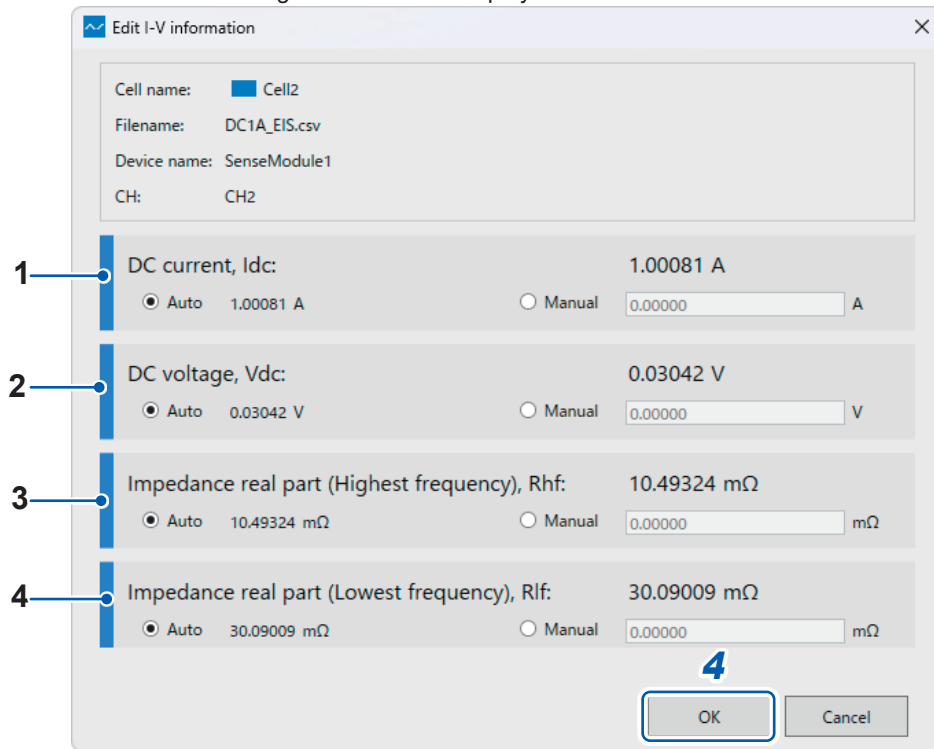

No.	Item	Description
1	DC current, I _{dc}	Measured DC current of the measurement target. When set to [Auto] , the measurement uses the average DC current value in the corresponding impedance measurement data.
2	DC voltage, V _{dc}	Measured DC voltage of the measurement target. When set to [Auto] , the measurement uses the average DC voltage value in the corresponding impedance measurement data.
3	Impedance real part (Highest frequency), R _{hf}	This is the real part value of the impedance at the highest frequency, and this value is used to draw the I-Impedance Plot. When set to [Auto] , the measurement uses the real parts of the impedance data at the highest frequency in the respective channel.
4	Impedance real part (Lowest frequency), R _{lf}	This is the real part value of the impedance at the lowest frequency, and this value is used to draw the I-Impedance Plot. When set to [Auto] , the measurement uses the real parts of the impedance data at the lowest frequency in the respective channel.

3 Edit each item.

- **[Auto]** : automatically use the value calculated from the measurement.
- **[Manual]** : manually enter each value.

4 Click **[OK]**.

The new data values setting will be applied to the results.

I-V information data edited in [Manual]

- Edited data in **[Manual]** will have small yellow pointer.
- I-V data that includes edited data in **[Manual]** will be displayed as a dashed line on the graph.

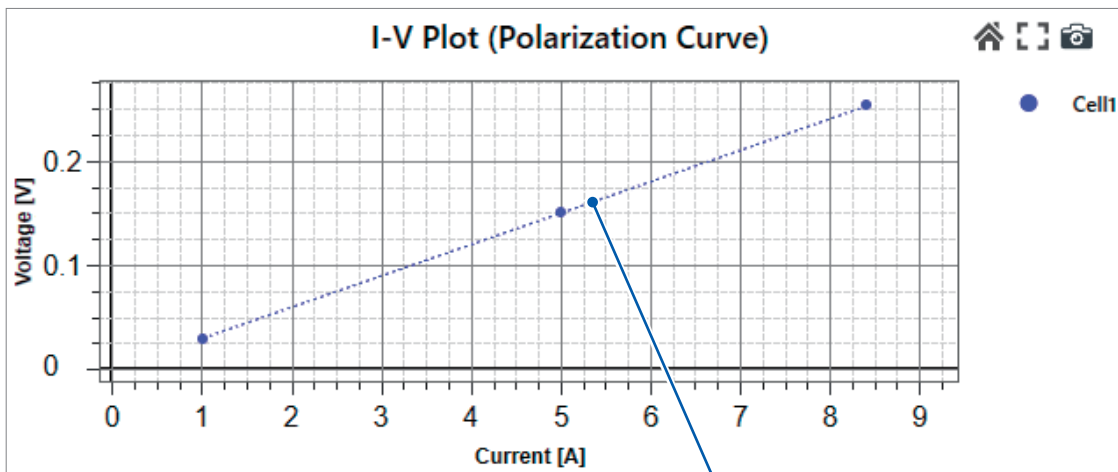
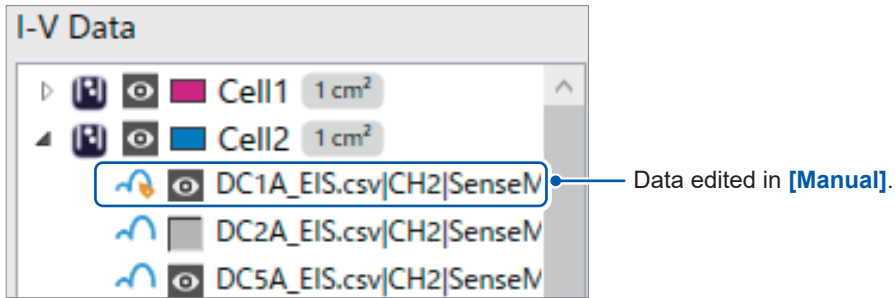

I-V data that includes edited data in **[Manual]**

6.4 Exporting the I-V Data to a File

- 1 Click the I-V data ([I-V DATA]) tab.
- 2 Right-click on the cell information of the [I-V Data] list, and then select [Export I-V data].

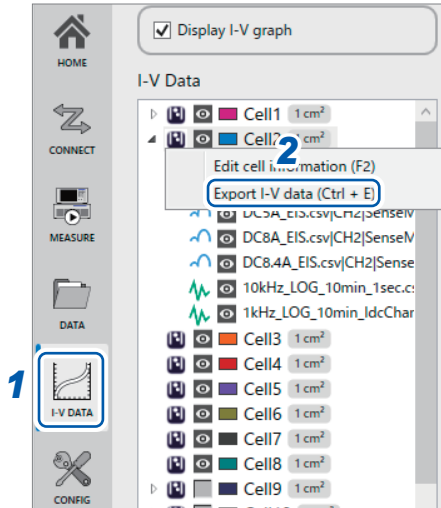

The Export I-V Data Options window will be displayed.

- 3 Specify the saving destination file path and file name for the I-V data, and then click [OK].

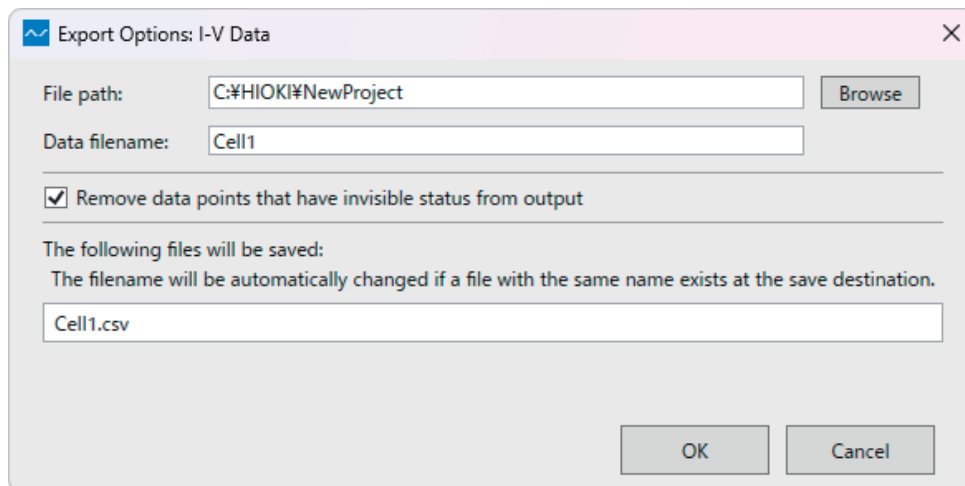

The I-V data will be output to a CSV file.
The format of the I-V data is listed below.

Item	Unit	Description
Idc	A	The DC current value set in [Edit I-V information] window is applied (Auto/Manual).
Vdc	V	The DC voltage value set in [Edit I-V information] window is applied (Auto/Manual).
Current Density	A/cm ²	The current density is calculated by dividing the DC current value by the cross-sectional area of the cell.
Rhf	Ω	The impedance real part value corresponding to the highest frequency in the data set from the [Edit I-V information] window.
Rlf	Ω	The impedance real part value corresponding to the lowest frequency in the data set from the [Edit I-V information] window.

7.1 Graph Common Operation

Setting for Displaying or Hiding the Measurement Data Graph



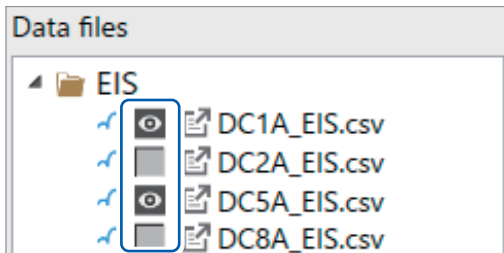

You can select or deselect the  mark to show or hide data on the graph.

For data files







Changes the display for all data in the selected file.

For target information

Target information			
	Cell Name	Device	CH
	Cell1	SenseModule1	CH1
	Cell2	SenseModule1	CH2
	Cell4	SenseModule1	CH4
	Cell5	SenseModule1	CH5

Changes the display for data from the selected channel.

For the data table

DC1A_EIS.csv SenseModule1 CH1 Cell1					
	Info	No.	R [mΩ]	X [mΩ]	Frequency [Hz]
		1	10.52955	-0.45660	10000
		2	10.63287	-0.89698	5000
		3	10.99809	-2.39475	2000
		4	11.81300	-4.47578	1000

Changes the display for each selected data point.

Viewing Graphs

Viewing Graphs Using the Buttons

You can control the graph view with the buttons located at the top of the graph.



No.	Button label	Description
1	Point	Displays the graph using points only.
2	Line	Displays the graph using lines only.
3	Line&Point	Displays the graph using both points and lines.
4	Reset Axes	Resets the graph to its default view, automatically scaling it to fit the entire graph with zeros on both axes.
5	Auto Scale	Resets the graph to its default view, automatically scaling it to fit the entire graph.
6	Plot Highlight	Impedance graph only The graph line of the selected data will be shown in its original color, while other lines will be grayed out. This feature makes it easier to focus on a specific set of data when multiple data sets are displayed on the graph.
7	Snap Shot	Captures the graph display and saves it as an image.

Viewing graphs using the mouse

You can use these mouse action to explore and analyze the graph data more effectively.

Mouse operation	Description
Left-click and drag	Enlarges selected area.
Right-click and drag	Grab and move the graph.
Double left-click	Resets the graph to its default view, automatically scaling it to fit the entire graph.
Double right-click	If a point was selected, this action will cancel the data point selection on the graph.
Scroll wheel	Zoom in and out.

Displaying the Data Details on Graphs

1 Hover the mouse cursor to a point on the graph.

The measurement information at that data point will appear.

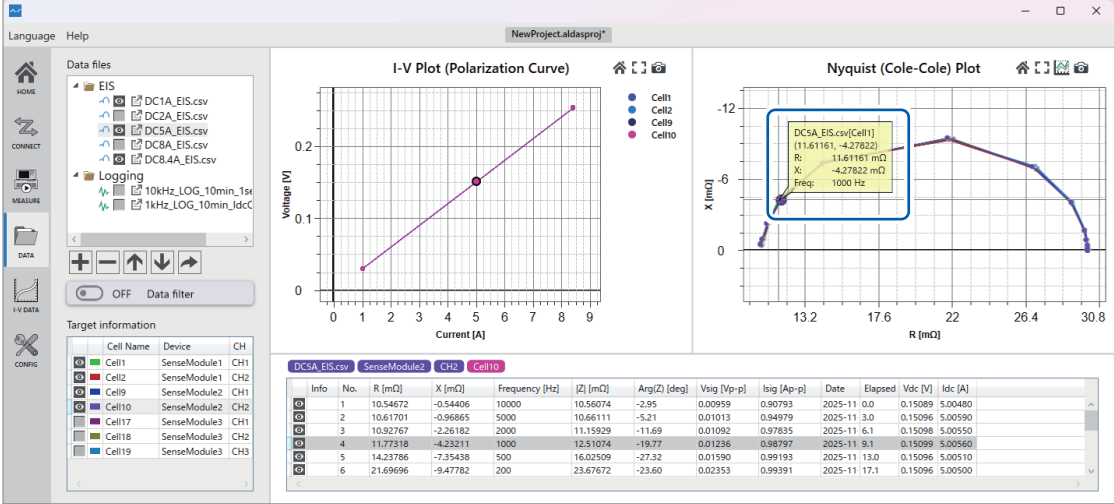

2 Click a point on the graph.

The selected point will be highlighted.

The data file, target information, and data table corresponding to the selected plot are displayed in each screen element. Additionally, the corresponding data is selected in the data table.

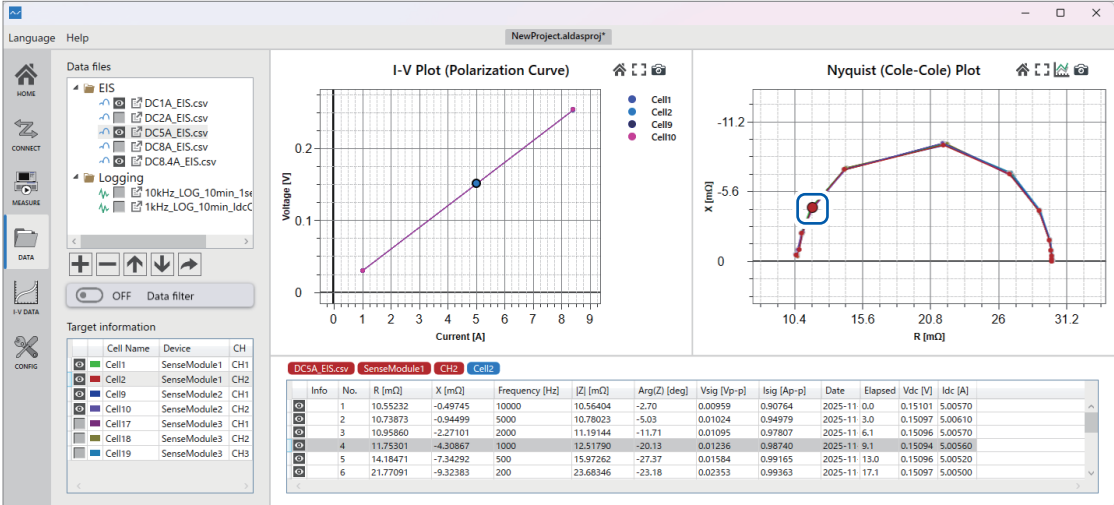

7

PC application functions

Setting the Graph Color and Marker Shape

- 1 Click the colored square button.

Target information			
	Cell Name	Device	CH
	Cell1	SenseModule1	CH1
	Cell2	SenseModule1	CH2
	Cell4	SenseModule1	CH4
	Cell5	SenseModule1	CH5

A **[Plot Options]** setting window will be displayed for the selected target information.

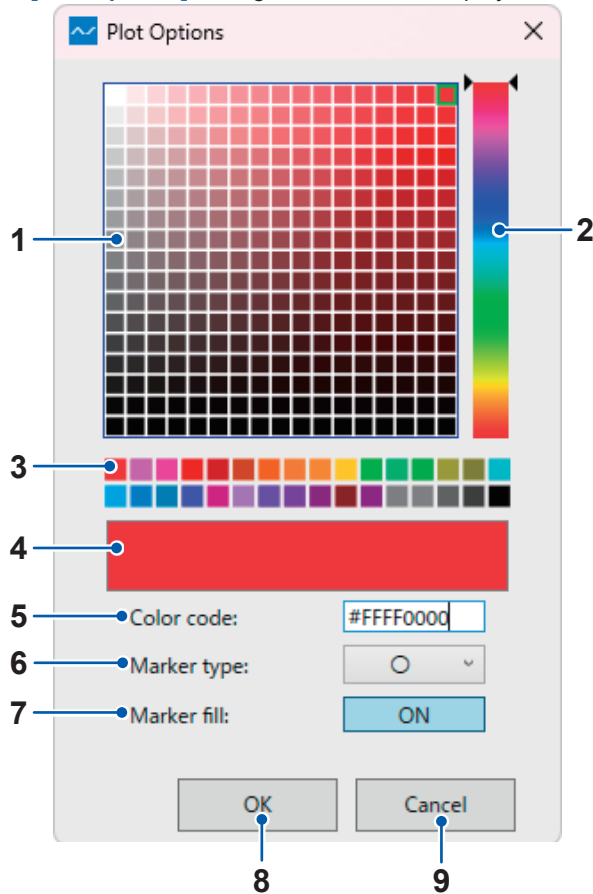

No.	Description
1	Select the graph color from a grid display.
2	Select a hue from a color bar.
3	Select the graph color from a number of color presets.
4	Displays the selected color.
5	Displays the color code for the selected color. You can also edit the color code directly.
6	Select the marker shape.
7	Enable or disable marker fill.
8	Click [OK] to apply the changes to the graph.
9	Discards changes and closes the window.

7.2 Manipulating Measurement Conditions Files

Adding, deleting, sorting, and previewing the measurement conditions

- 1 Click the Measurement settings ([MEASURE]) tab.
- 2 Use the files using the buttons at the bottom of the [Measurement conditions files] list.

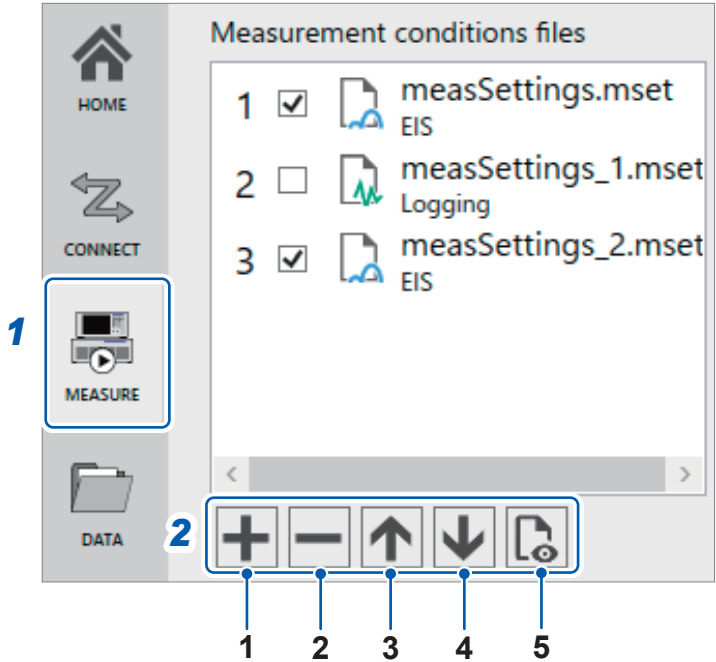

No.	Button label	Description
1	Add	Adds a new measurement condition.
2	Delete	Deletes the selected file.
3	Up	Moves the selected file up.
4	Down	Moves the selected file down.
5	Preview	Displays a preview of the measurement conditions.

Change the existing measurement conditions

Modify the existing measurement conditions if required.

- 1 Click the Measurement settings ([MEASURE]) tab.
- 2 Choose the file to be edited from the [Measurement conditions files] list and double-click to open.

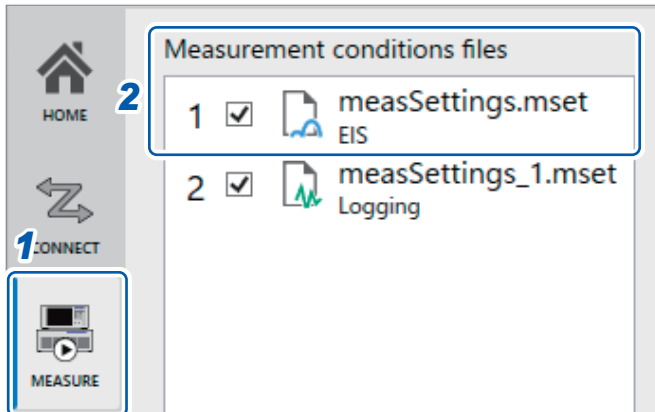

The measurement conditions setting window will be displayed.

- 3 Modify the desired parameter, and then click [Complete].

For more information about how to set new measurement conditions, see “3.4 Setting the Measurement Method” (p.48).

Navigate the [Measurement settings] by selecting the tab available on the left-hand side of the [Project Settings] window.

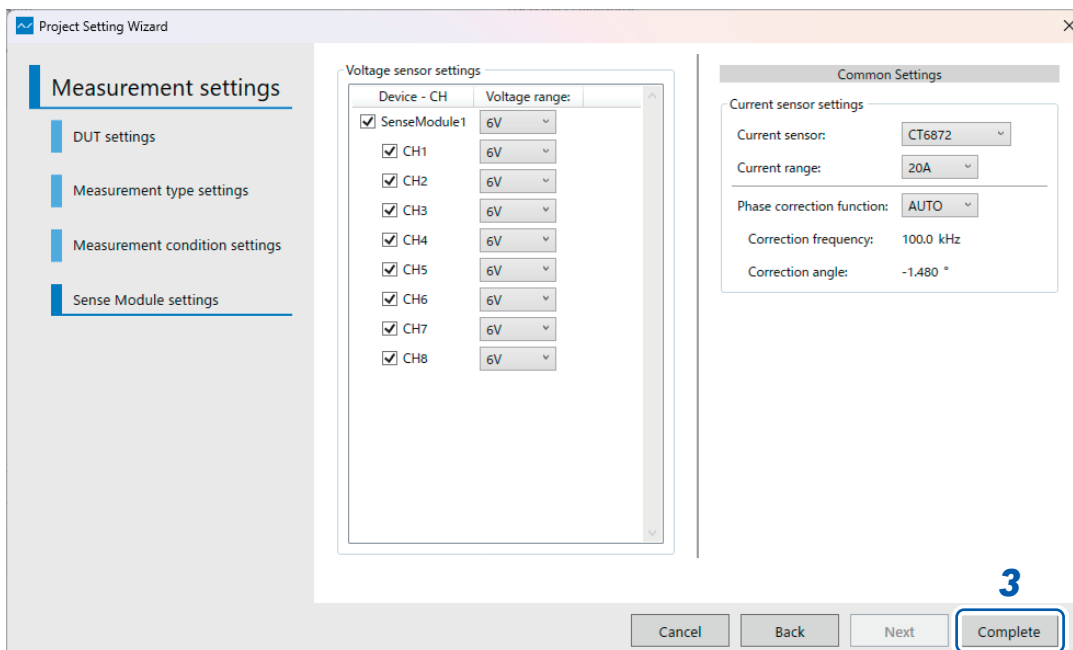

A dialog box will be displayed to confirm overwriting the settings.

- 4 Click [Yes].

This will overwrite the measurement conditions with the new settings and save them.

Adding the existing measurement conditions

If you wish to copy and use measurement conditions created in another project, you can load them to this project [\[Measurement condition files\]](#) list.

Measurement conditions files are saved in the [\[MeasurementSettings\]](#) folder with “.mset” extension in the project folder.

- 1** Click the Measurement settings ([\[MEASURE\]](#)) tab.
- 2** Drag and drop the measurement conditions file you wish to load onto the [\[Measurement conditions files\]](#).

The measurement conditions will be loaded to the [\[Measurement conditions files\]](#) list.

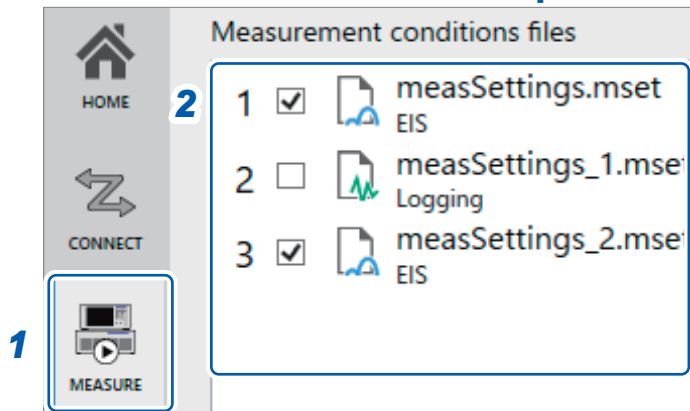

Changing the name of measurement conditions

The filename used to store the measurement conditions can be modified.

1 Right-click the desired file in the [Measurement conditions files] list to rename it.

The context menu will be displayed.

Pressing the F2 key while a file is selected will also display the screen for changing the measurement conditions filename.

2 Click [Rename the measurement conditions file].

The file rename dialog will be displayed, showing the current and new filename fields.

A new filename that is identical to the current filename is considered invalid.

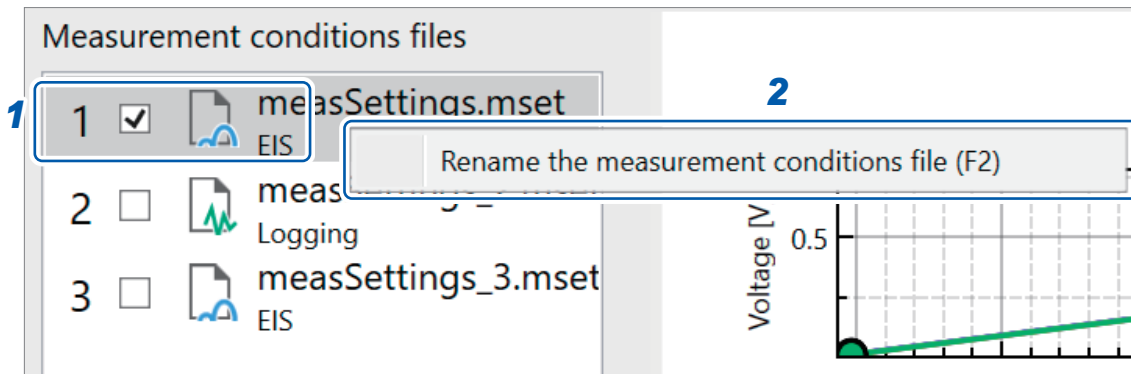

7.3 Manipulating Data Files

Loading a data file

The following files can be loaded: ALDAS format, Multi-plot format, and ZView (third-party company's trademark) format.

- ALDAS format: Data format for measurement results output by the ALDAS software.
- Multi-plot format: Data format used by Multi-plot, Hioki's web application
- ZView format: Data format used by the Scribner's Zview equivalent circuit analysis software

There are a number of ways to load data files from an external source.

Adding a data file by dragging and dropping it

Load a data file in a compatible format by dragging and dropping it onto the **[Data files]** list or directly onto a graph.

For ALDAS format files, the graph category will be automatically recognized when the file is loaded. Files not in the ALDAS format can be loaded as the **[EIS]** category files.

Adding data by right-clicking a category in the **[Data files]** list

To add data, use the options available in the right-click context menu.

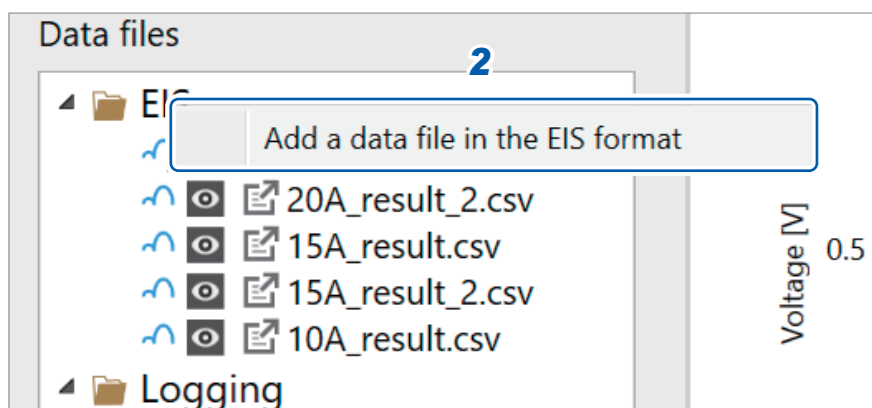

- 1** Select either the **[EIS]** or the **[Logging]** category in the **[Data files]** list and click the right mouse button.

The context menu will be displayed.

- 2** Click **[Add a data file in the EIS format]**.

The data file selection window will be displayed.

- 3** Open the data file.

The data will be loaded using the selected category.

Adding data using the data file **[+]** button

Click the **[+]** button underneath the **[Data files]** list and select an option from the menu to add data.

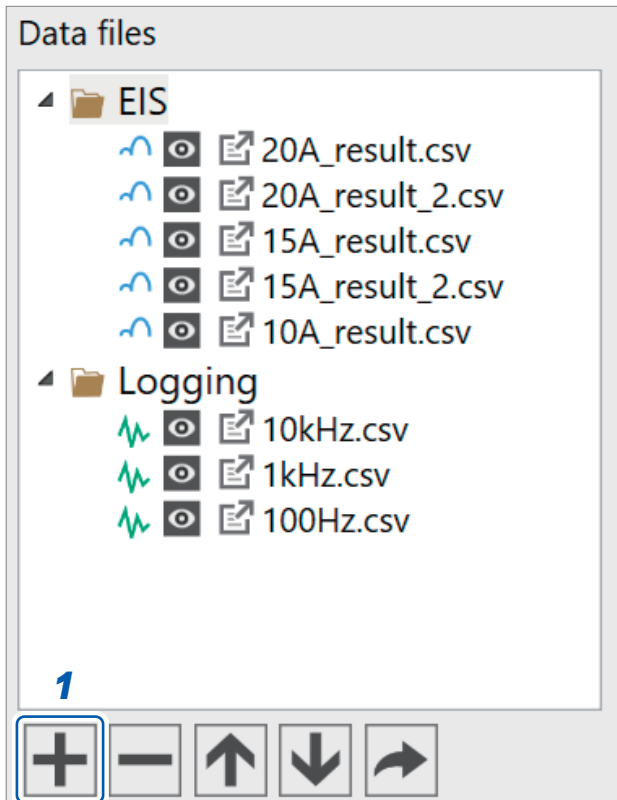

1 Click the **[+]** button underneath the **[Data files]** list.

The context menu will be displayed.

2 Select and click the desired operation.

- Add a data file in the EIS format
 - Add a data file in the logging format
- The data file selection window will be displayed.

3 Open the data file.

The data will be loaded using the selected category.

Loading data measured in a different project (including measurement conditions)

Folders named **[Data filename_Archive]** are generated in the **[DataFiles]** folder in the project folder.

To load a **[.darchive]** file, drag and drop it onto the **[Data files]** list or a graph of the open project. Loading the file in this way includes all data and a link to the original measurement conditions.

Changing a data file's name

The names of data files can be changed.

- 1** From the [Data files] list, right-click the file to be renamed.

The context menu will be displayed.

- 2** Click [Rename the data file].

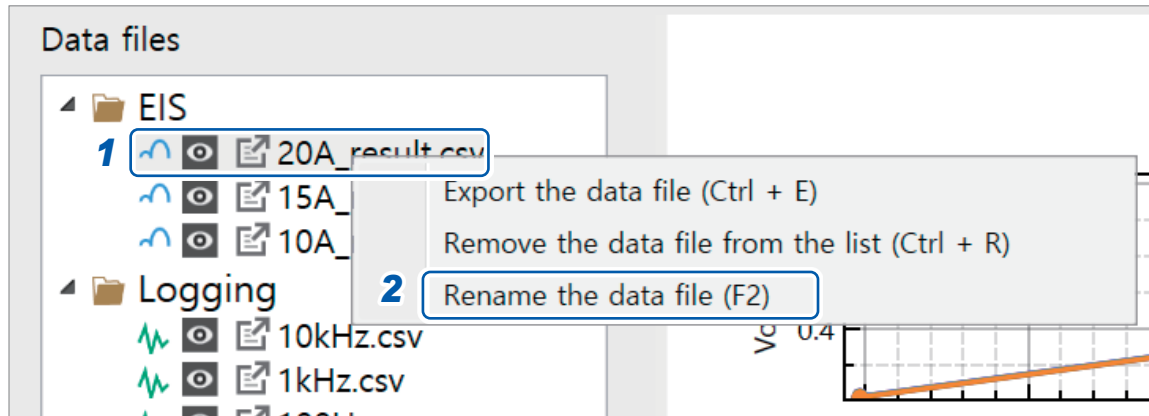

The dialog will be displayed, showing the current and new filename fields. A new filename that is identical to the current filename is considered invalid.

- 3** Enter a new filename and click [OK].

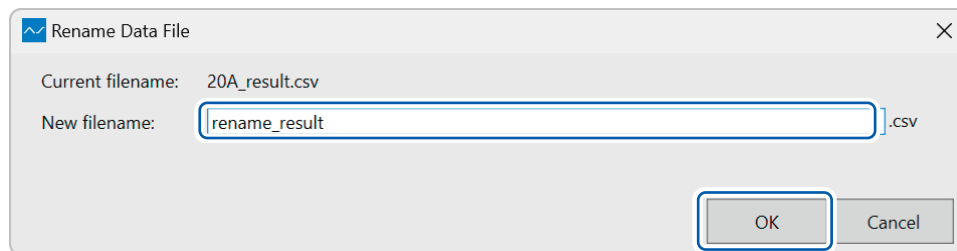

Removing a data file from the list

Deleting a file on the list

Data files can be deleted from the list.

1 Right-click the data file to be deleted.

The context menu will be displayed.

2 Click **[Remove the data file from the list]**.

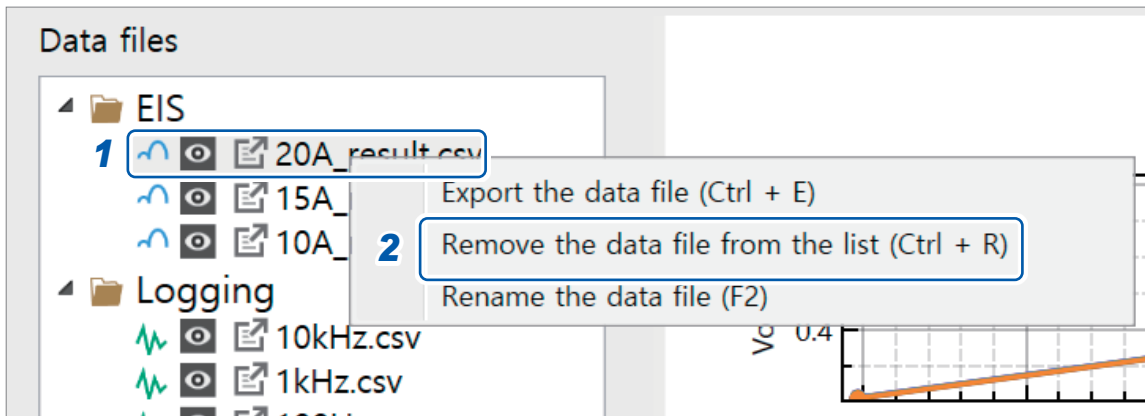

A confirmation dialog box will be displayed.

3 Click **[Yes]**.

The data file will be removed from the list.

The data file will be removed from the measurement project but will remain in the project folder's **[DataFiles]** folder.

Deleting a file using the context menu

Data files can be deleted using the context menu.

- 1** Select the data file to be deleted.
- 2** Click the [-] button underneath [Data files].
The context menu will be displayed.
- 3** Click [Remove the selected data file from the list].

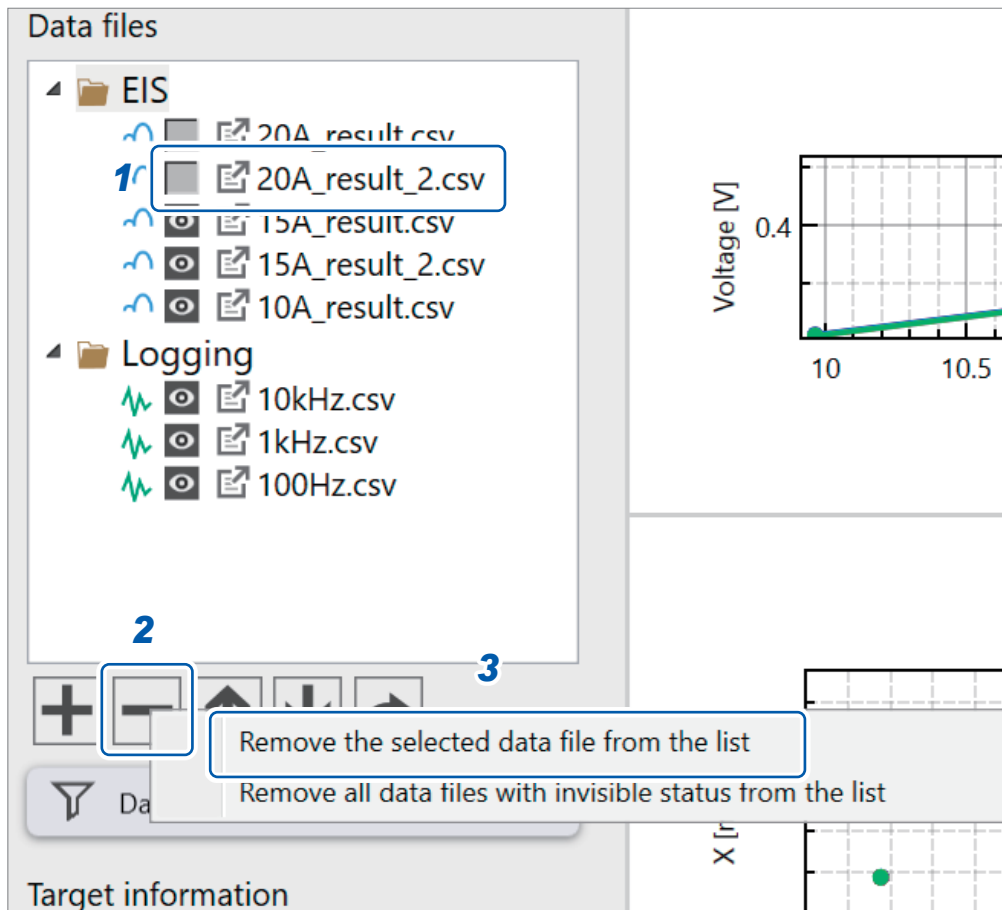

A confirmation dialog box will be displayed.

- 4** Click [Yes].
The data file will be removed from the list.

Exporting data files

1 Right-click the data file to be exported in an different file format.

The context menu will be displayed.

2 Click [Export the data file].

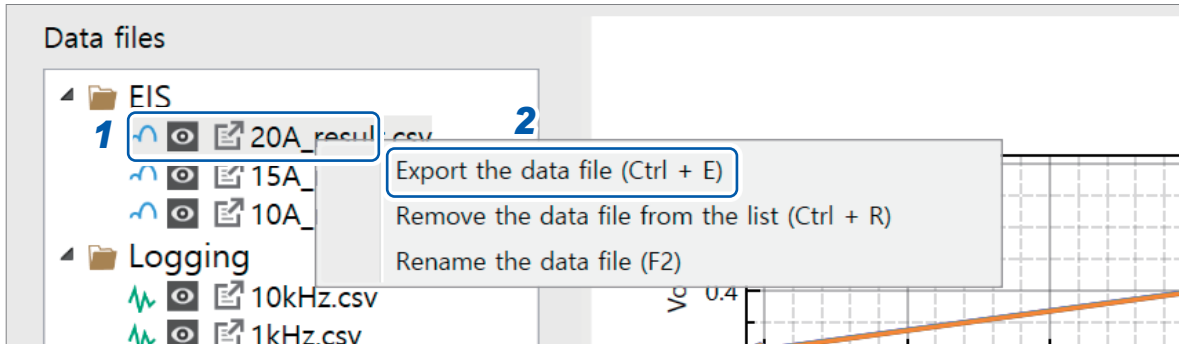

The data file export window will be displayed.

The following export options can be configured:

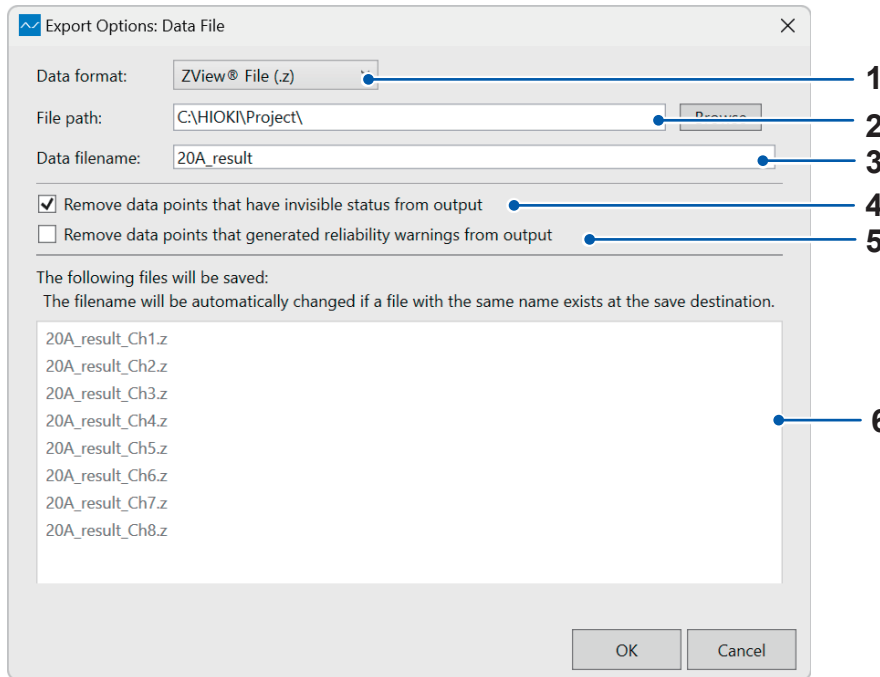

No.	Item	Description
1	Data format	The data file can be saved in either ZView format [ZView File(.Z)] or Multi-plot format [Multi-plot File(.csv)] .
2	File path	Specifies the folder in which to save the file.
3	Data filename	Specifies the new data file name.
4	Remove data points that have invisible status from output	In Data table, removes data with no  mark from the output file.
5	Remove data points that generated reliability warnings from output	In Data table, removes data with a warning icon shown in [Info] from the output file.
6	The following files will be saved	Displays a list of data file names that will be saved.

The ALDAS data format

[ChannelNo.] will be replaced by the channel number.

Example: For CH2, "R_SenseModule1_Ch2], etc.

EIS format

Item	Unit	Description
Date		The date corresponds to the start of data acquisition.
ElapsedTime	s	Total time that has passed since the measurement begin.
SetFrequency	Hz	Frequency set in the measurement conditions.
MeasuredFrequency_SenseModule1_Ch[ChannelNo.]	Hz	Indicates the frequency at which the impedance was measured.
R_SenseModule1_Ch[ChannelNo.]	Ω	Real part of the impedance.
X_SenseModule1_Ch[ChannelNo.]	Ω	Imaginary part of the impedance.
AbsZ_SenseModule1_Ch[ChannelNo.]	Ω	Absolute value of the impedance.
ArgZ_SenseModule1_Ch[ChannelNo.]	$^{\circ}$	Phase angle of the impedance.
Vsig_SenseModule1_Ch[ChannelNo.]	Vp-p	Peak-to-peak of signal's voltage amplitude at the impedance measurement frequency.
Isig_SenseModule1_Ch[ChannelNo.]	Ap-p	Peak-to-peak of signal's current amplitude at the impedance measurement frequency.
Vdc_SenseModule1_Ch[ChannelNo.]	V	Measured DC voltage.
Idc_SenseModule1_Ch[ChannelNo.]	A	Measured DC current.

Logging format

Item	Unit	Description
ElapsedTime	s	Total time that has passed since the measurement begin.
Date		The date corresponds to the start of data acquisition.
SetFrequency	Hz	Frequency set in the measurement conditions.
MeasuredFrequency_SenseModule1_Ch[ChannelNo.]	Hz	Frequency at which the impedance was measured.
R_SenseModule1_Ch[ChannelNo.]	Ω	Real part of the impedance.
X_SenseModule1_Ch[ChannelNo.]	Ω	Imaginary part of the impedance.
AbsZ_SenseModule1_Ch[ChannelNo.]	Ω	Absolute value of the impedance.
ArgZ_SenseModule1_Ch[ChannelNo.]	$^{\circ}$	Phase angle of the impedance.
Vsig_SenseModule1_Ch[ChannelNo.]	Vp-p	Peak-to-peak of signal's voltage amplitude at the impedance measurement frequency.
Isig_SenseModule1_Ch[ChannelNo.]	Ap-p	Peak-to-peak of signal's current amplitude at the impedance measurement frequency.
Vdc_SenseModule1_Ch[ChannelNo.]	V	Measured DC voltage.
Idc_SenseModule1_Ch[ChannelNo.]	A	Measured DC current.

7.4 Checking the System Connection Status and Reconnection

The measurement condition cannot be set if the application fails to verify the connection to the system devices after starting the project. Please verify the connection using the following steps:

- 1 Open the Connection settings (**[CONNECT]**) tab and click the **[Connection status]** button.



- 2 To reconnect, click either the **[Connected]** or **[Not connected]** button.

A window for **[Instrument settings]** will be displayed.

Click either the **[Connected]** or **[Not connected]** button to reconnect with the system.

See “3.3 Connecting to the System Instruments” (p.46).

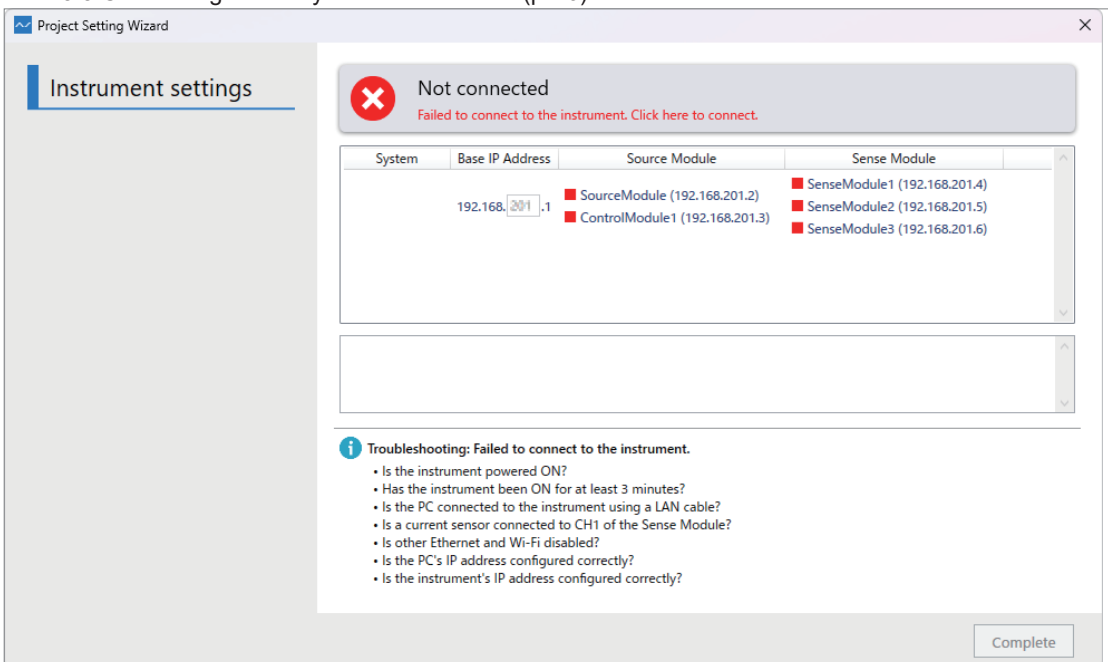

7.5 Manipulating Project Files

1 Use the project files in the [HOME] tab window.

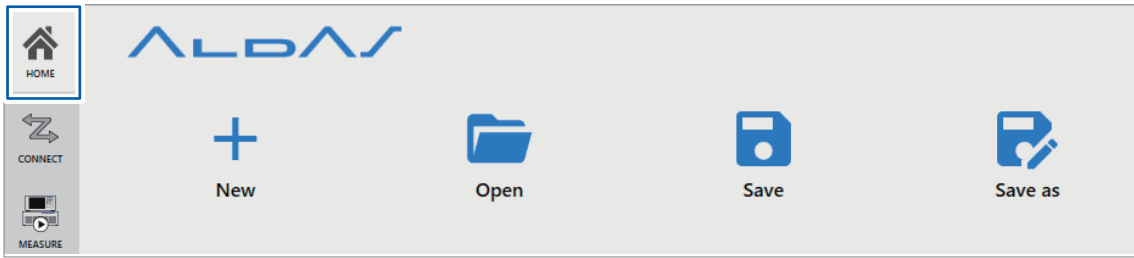

Button label	Description
New	Creates a new project. Perform settings according to “3 Configuring the PC Application” (p.43).
Open	Opens an existing project. Go to the directory of the project you wish to open in the file selection window, and then select the [Project name.aldasproj] file.
Save	Saves the status of the current project. Alternatively, use [ctrl]+[s] keys while the application is active will save the current project’s state. The following information is saved when a project is saved: <ul style="list-style-type: none"> • Hardware component information • Measurement conditions file list • Data file list • Data files and Measurement condition file links • Data display/hide attributes • Graph color and marker shape information • Data reliability information
Save as	You can change a project’s name as well as the directory in which it is stored. A folder with the same name as the project will be created in the specified directory, and the project file and related data files will be copied into it.

8

Ending Measurement

8.1 Exiting the PC application

1 Confirm that the measurement operation has ended.

If any changes were made to the project, please save the project before exiting. (The current project file will be overwritten.)

2 Click the close button on the window.

The PC application will close.

8.2 Turn off the system instruments

CAUTION



- Ensure the measurement target's DC power supply is turned off and the system detects no voltage or current before shutting down the system.

Failure to do so may result in system damage.

1 Turn off the external DC power supply if it is connected to the measurement target.

Skip this step for measurements without an external DC power supply (or external load), or for FC.

2 Verify that there is no voltage or current detected from the measurement target by the Sense Module.

3 Press the Power button on the Sense Module to switch it off.

The Sense Module will turn off.

4 Switch off the Source Module power switch.

The Source Module will turn off.

8.3 Disconnect the cables and current sensor from the measurement target

DANGER



- Turn off measurement target's power supply before disconnecting the Sense Cable, Source Cable, and current sensor.

Failure to do so could result in electric shock.

1 Disconnect the Sense Cable, current sensor, and Source Cable from the measurement target.

Disconnect the cables and current sensor from the measurement target

9.1 EA5703 ALDAS-α

General specifications

(1) PC application operating environment

Operating system	Windows11 Home/Pro/Enterprise/Enterprise LTSC
.NET library	Microsoft .NET Framework Runtime 4.8.1 or later
Processor	Intel® Core i5 or higher (clock speed of 2 GHz or higher and at least 2 physical cores recommended)
RAM	At least 8 GB
Storage	Available space: At least 2 GB
Display	Resolution of at least 1366 × 768 pixels
Interfaces	LAN (communications between the modules and PC) USB Type A (license authentication)
License certification type	USB dongle key (license key)
Recommended PC IP address	192.168.200.5 to 192.168.200.255
Valid PC IP address setting range	192.168.0.0 to 192.168.255.255 The following IP addresses may not be used as they are reserved for use by modules: 192.168.200.1 to 192.168.200.4
PC subnet mask settings	255.255.0.0

(2) System architecture

ALDAS-α	EA5301 Sense Module									
	EA5503 Source Module									
	EA5703 ALDAS-α (PC application)									
Accessories	See p.6									
ALDAS-α	EA5703 ALDAS-α (PC application)									
	EA5301 Sense Module • Configuration unit: 1									
	<table border="1"> <thead> <tr> <th>Display name</th> <th>IP address</th> <th>Subnet mask</th> </tr> </thead> <tbody> <tr> <td>Sense Module 1</td> <td>192.168.200.4</td> <td>255.255.0.0</td> </tr> </tbody> </table>	Display name	IP address	Subnet mask	Sense Module 1	192.168.200.4	255.255.0.0			
Display name	IP address	Subnet mask								
Sense Module 1	192.168.200.4	255.255.0.0								
	EA5503 Source Module • Configuration unit: 1									
	<table border="1"> <thead> <tr> <th>Display name</th> <th>IP address</th> <th>Subnet mask</th> </tr> </thead> <tbody> <tr> <td>Source Module</td> <td>192.168.200.2</td> <td>255.255.0.0</td> </tr> <tr> <td>LAN hub</td> <td>192.168.200.1</td> <td>255.255.0.0</td> </tr> </tbody> </table>	Display name	IP address	Subnet mask	Source Module	192.168.200.2	255.255.0.0	LAN hub	192.168.200.1	255.255.0.0
Display name	IP address	Subnet mask								
Source Module	192.168.200.2	255.255.0.0								
LAN hub	192.168.200.1	255.255.0.0								

Functional specifications (PC application functionality)

(1) Impedance measurement

Configurable frequency range	10 mHz to 100 kHz	
Impedance measurement frequency range	10 mHz to 10 kHz	
EIS Mode (Frequency Sweep)	Measures impedance at multiple user-specified frequencies.	
Logging Mode (Fixed Frequency)	Repeatedly measures impedance at one user-specified frequency. Total measurement time: 1 s to 180 days Logging interval: 1 s, 2 s, 5 s, 10 s, 30 s, 1 min., 2 min., 5 min., 10 min., 30 min., 1 hour Maximum number of repeating measurement points (per channel, per set of measurement conditions): 5,000	
Impedance measurement method	Real part $R = U_{sig} / I_{sig} * \cos\theta$	
	Imaginary part $X = U_{sig} / I_{sig} * \sin\theta$	
	Symbol	R : Impedance real part [Ω] X : Impedance imaginary part [Ω] U_{sig} : Voltage p-p value [V] for the impedance measurement frequency component I_{sig} : Current p-p value [A] for the impedance measurement frequency component θ : Voltage and current phase difference [$^\circ$]
Impedance measurement data	<ul style="list-style-type: none"> • ZView files (.z) • Multi-plot files (.csv) • ALDAS files (.csv) 	
ALDAS file output parameters	<p>Common for all measurement channels: Time and date, measurement elapsed time, frequencies set in measurement conditions</p> <p>For individual measurement channels: Frequencies measured, impedance real part, impedance imaginary part, impedance absolute value, impedance phase angle, voltage of impedance measurement frequency component, current of impedance measurement frequency component, DC voltage, DC current</p>	

(2) Measurement condition settings

Measurement speed setting	Fast, Medium, Slow Length of average processing increases in the following order: Slow > Medium > Fast.	
Impedance measurement frequency resolution	Set frequency f [Hz]	Frequency resolution [Hz]
	$10000 \leq f \leq 100000$	1000
	$1000 \leq f \leq 10000$	100
	$100 \leq f < 1000$	10
	$10 \leq f < 100$	1
	$1 \leq f < 10$	0.1
	$0.01 \leq f < 1$	0.01

(3) I-V characteristics measurement

I-V characteristics measurement function	When impedance measurement is performed, measures the DC current and DC voltage values and displays the DC current and DC voltage measured values when performing impedance under multiple conditions as I-V characteristics.
I-V measurement method	DC current Measures the DC current before signal superposition.
	DC voltage Measures the DC voltage before signal superposition.

(4) Graph function

Impedance graph	Nyquist (Cole-Cole) Plot	Horizontal axis: Impedance real part Vertical axis: Impedance imaginary part
	Bode Plot	Horizontal axis: Frequency Vertical axis: Impedance real part, imaginary part, absolute value, phase angle, current p-p value for impedance measurement frequency component, voltage p-p value for impedance measurement frequency component, current value for DC component, voltage value for DC component (select one)
	Logging Plot	Horizontal axis: Measurement time Vertical axis: Impedance real part, imaginary part, absolute value, phase angle, current p-p value for impedance measurement frequency component, voltage p-p value for impedance measurement frequency component, current value for DC component, voltage value for DC component (select one)
I-V graph	I-V Plot (Polarization Curve)	Horizontal axis: DC current Vertical axis: DC voltage
	IR-free Plot	Horizontal axis: DC current Vertical axis: IR-free voltage $V_{IR-free} = V_{dc} - R_{ohm} * I_{dc}$ $V_{IR-free}: \text{ IR-free voltage}$ $V_{dc}: \text{ DC voltage}$ $I_{dc}: \text{ DC current}$ $R_{ohm}: \text{ Ohmic resistance (user-defined)}$
	I-Power Plot	Horizontal axis: DC current Vertical axis: DC current $P = I_{dc} * V_{dc}$ $P: \text{ DC power}$ $V_{dc}: \text{ DC voltage}$ $I_{dc}: \text{ DC current}$
	I-Impedance Plot	Horizontal axis: DC current Vertical axis: Maximum frequency resistance (R_{hf}) or minimum frequency resistance (R_{lf}) (select one) $R_{hf}: \text{ Impedance real part at maximum frequency in impedance measurement file}$ $R_{lf}: \text{ Impedance real part at minimum frequency in impedance measurement file}$
Impedance graph maximum number of render points	400,000	

(5) Alarm function

Sense Module error detection	Current range exceeded	If an input exceeding the current range setting is detected, signal superposition and measurement will stop.
	Voltage range exceeded	If an input exceeding the voltage range setting is detected, signal superposition and measurement will stop.
Source Module error detection	Overheat detection	If an overheat condition is detected inside the EA5503 Source Module, signal superposition and measurement will stop.

(6) Saving of settings data

Saved data	<ul style="list-style-type: none"> • Application settings Project-related files' relative save path, measurement data list, graph settings • Hardware settings Interface and model information for connected devices • Measurement condition settings Measurement frequency, measurement amplitude, hardware settings • Information added to data Graph render information, alert information
Data format	XAML format

(7) Saving of measurement data

Saved data	Measurement time and date, elapsed time, set frequency, measurement frequency, impedance real part, impedance imaginary part, voltage of impedance measurement frequency component, current of impedance measurement frequency component, impedance absolute value, impedance phase angle, DC voltage, DC current
Data format	CSV file format

9.2 EA5301 Sense Module

General specifications

Operating environment	Indoor use, pollution degree 2, altitude up to 2000 m (6562 ft.)
Operating temperature and humidity range	0°C to 40°C (32°F to 104°F), 80% RH or less (no condensation)
Storage temperature and humidity range	-10°C to 50°C (14°F to 122°F), 80% RH or less (no condensation)
Standards	Safety: EN 61010 EMC: EN 61326 Class A
Power supply	Grid power Rated supply voltage: 100 to 240 V AC (Assuming voltage fluctuations of $\pm 10\%$ of the rated supply voltage) Rated power supply frequency: 50 Hz/60 Hz Anticipated transient overvoltage: 2500 V Maximum rated power: 150 VA for only main unit
Backup battery life	Lithium batteries: about 10 years (reference value at 23°C) Time/setting conditions
Dimensions	Approx. 430W × 221H × 361D mm (16.9W × 8.7H × 14.2D in.) (excluding protruding parts)
Weight	Approx. 12.7 kg (28.0 lb.) (EA5301-08)
Product warranty duration	1 year
Accessories	See p.6.
Options	See p.7.

Input, output, measurement specifications

(1) Voltage and current measurement shared specifications

Number of input units	Max. 8 units
Sampling	15 MHz, 18 bits
Measurement frequency band	DC, 0.1 Hz to 5 MHz
Effective measuring range	1% to 100% of range

(2) Voltage measurement specifications

Number of input channels	1 channel: EA5301-01 2 channels: EA5301-02 3 channels: EA5301-03 4 channels: EA5301-04 5 channels: EA5301-05 6 channels: EA5301-06 7 channels: EA5301-07 8 channels: EA5301-08
Input terminal profile	Plug-in terminals (safety terminals)
Input type	Isolated, resistive potential divider
Range	6 V, 15 V, 30 V, 60 V
Crest factor	3 relative to voltage range ratings
Input resistance, input capacitance	4 M Ω \pm 20 k Ω , 6 pF typical
Maximum input voltage	\pm 60 V The signal superposition terminal rating for the EA5503 Source Module is \pm 20V.
Maximum rated voltage to earth	\pm 60 V

(3) Current measurement specifications

Number of input channels	1 channel (only CH1 enabled)
Input terminal profile	Probe1: Dedicated connector (ME15W)
Input type	Current sensor input method
Range	<ul style="list-style-type: none"> • Probe1: 40 mA, 80 mA, 200 mA, 400 mA, 800 mA, 2 A (with 2 A sensor) 400 mA, 800 mA, 2 A, 4 A, 8 A, 20 A (with 20 A sensor) 1 A, 2 A, 5 A, 10 A, 20 A, 50 A (with 50 A sensor)
Crest factor	3 relative to current range ratings

(4) Impedance measurement specifications

Impedance measurement repeatability

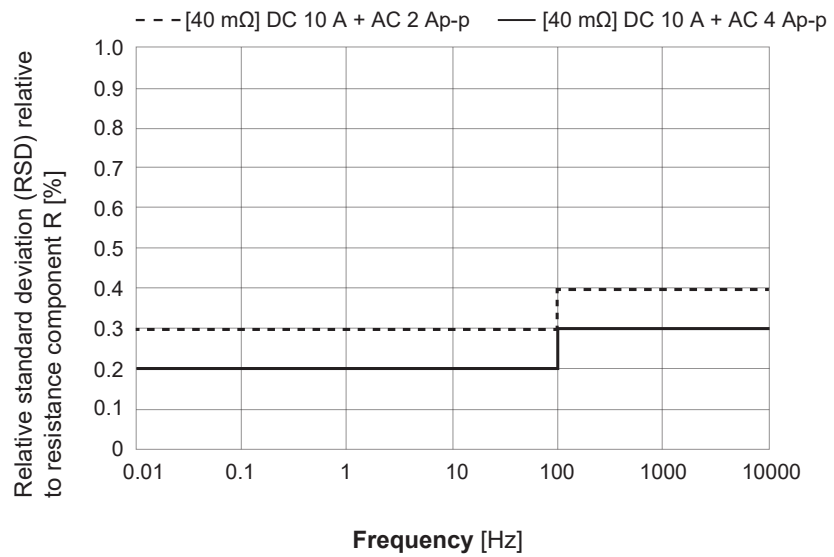

Relative standard deviation of measured resistance value when measuring resistive load
(R = 40 mΩ, 10 A DC)

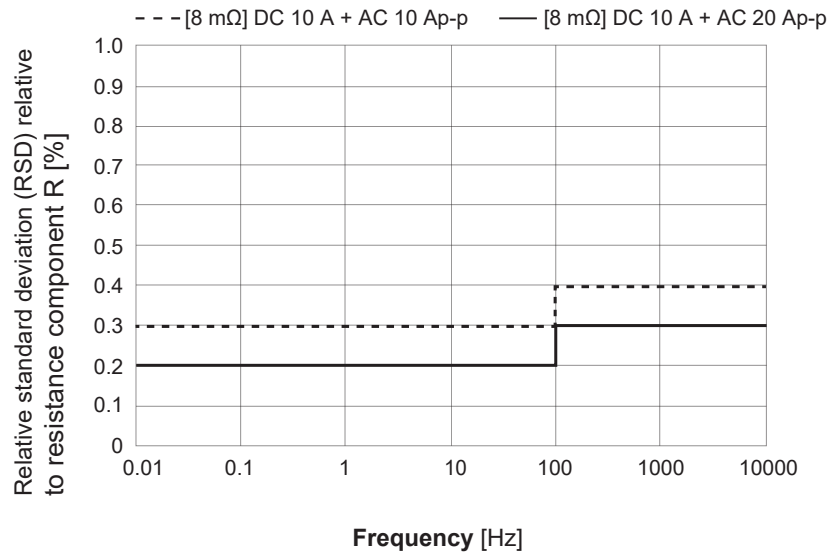

Relative standard deviation of measured resistance value when measuring resistive load
(R = 8 mΩ, DC 10 A)

Measurement conditions:

- Software: EA5703 ALDAS-α
- Voltage Range: 6 V
- Current Sensor: CT6841A
- Current Range: 20 A range
- Other Settings: FAST measurement speed, noise reduction enabled
- Free from electrical noise

(5) Accuracy specifications

Accuracy guarantee conditions	Accuracy guarantee duration: 1 year Accuracy guarantee temperature and humidity range: 23°C ±3°C, 80% RH or less Warm-up time: 30 min. or more Other: Sine-wave input, power factor of 1 or DC input, terminal-to-ground voltage of 0 V, within ±1°C after zero adjustment, within accuracy guarantee range	
Accuracy guarantee range	1% to 100% of range	
Voltage, current, and phase angle measurement accuracy	± (% of reading + % of range) (Typical)	
	Voltage (U)	Current (I)
	DC	0.07% + 0.03%
	$f = 100 \text{ Hz}$	0.02% + 0.02%
	$100 \text{ Hz} < f \leq 440 \text{ Hz}$	0.04% + 0.02%
	$440 \text{ Hz} < f \leq 1 \text{ kHz}$	0.05% + 0.04%
	$1 \text{ kHz} < f \leq 10 \text{ kHz}$	0.13% + 0.05%
	$10 \text{ kHz} < f \leq 50 \text{ kHz}$	0.25% + 0.05%
	$50 \text{ kHz} < f \leq 100 \text{ kHz}$	$(0.01 \times f + 0.20)\% + 0.1\%$
	° (Typical)	
	Phase angle (ϕ) (Phase difference)	
	$f = 100 \text{ Hz}$	±0.15°
	$100 \text{ Hz} < f \leq 440 \text{ Hz}$	±0.15°
	$440 \text{ Hz} < f \leq 1 \text{ kHz}$	±0.15°
	$1 \text{ kHz} < f \leq 10 \text{ kHz}$	±0.72°
	$10 \text{ kHz} < f \leq 50 \text{ kHz}$	$(0.020 \times f) \pm 0.7^\circ$
	$50 \text{ kHz} < f \leq 100 \text{ kHz}$	$(0.030 \times f) \pm 2.4^\circ$
	<ul style="list-style-type: none"> • In the expressions listed above, the unit of f is kilohertz. • Voltage and DC current accuracy figures are defined for DC voltage and current. Accuracy figures for frequencies other than DC are defined for RMS values. • Phase difference accuracy values are defined for 100% input with a power factor of 0. • For current and phase angle, add the current sensor's accuracy to the above accuracy figures. • When using the 6 V range for voltage measurement, add ±0.02% of range to the voltage accuracy. • When using a range that is 1/10, 1/25, or 1/50 of the current sensor's rating, add ±0.02% of range to the current accuracy. • If the temperature varies by ±1°C or more after zero adjustment, add ±0.01% of range per °C to the DC voltage and current accuracy. 	
Effects of temperature	0°C to 20°C or 26°C to 40°C: Add ±0.01% of reading per °C to the voltage and current accuracy. For DC, add another 0.01% of range per °C.	
Effects of external magnetic fields	±1% of range or less (400 A/m, in DC or 50 Hz/60 Hz magnetic field)	

Function specifications

(1) Current sensor phase correction

Functionality	Corrects current sensor high-frequency phase characteristics in calculations.
Operating modes	OFF/AUTO The AUTO setting can be selected when connected to a current sensor that supports the automatic detection function.
Correction value setting	Sets the frequency and phase difference for correction points. Frequency: 0.1 kHz to 5000.0 kHz (0.1 kHz increments) Phase difference: 0.000° to ±180.000° (0.001° increments) When the operating mode is set to AUTO, these settings are configured automatically when a sensor is connected.

Interface specifications

(1) LAN

Number of ports	For PC connection: 1 port
Connector	RJ-45
Rating/method	IEEE 802.3ab compliant
Transmission method	1000BASE-T auto negotiation
Protocol	TCP/IP
Communication details	Settings and inquiries with communication commands from the PC application for the EA570x ALDAS
IP address (fixed)	IP address: 192.168.200.4 Subnet mask: 255.255.0.0 Default gateway: 0.0.0.0 (None) Communication command port No.: 23

9.3 EA5503 Source Module

General specifications

Operating environment	Indoor use, pollution degree 2, altitude up to 2000 m (6562 ft.)	
Operating temperature and humidity range	0°C to 40°C (32°F to 104°F), 85% RH or less (no condensation)	
Storage temperature and humidity range	-10°C to 50°C (14°F to 122°F), 90% RH or less (no condensation)	
Standards	Safety: EN 61010 EMC: EN 61326 Class A	
Power supply	Grid power	
	Rated supply voltage:	100 to 240 V AC (Assuming voltage fluctuations of $\pm 10\%$ of the rated supply voltage)
	Rated power supply frequency:	50 Hz/60 Hz
	Anticipated transient overvoltage:	2500 V
	Maximum rated power:	900 VA for only main unit (under rated load)
Backup battery life	About 3 years	
Dimensions	Approx. 430W × 128H × 550D mm (16.9W × 5.0H × 21.7D in.) (excluding protruding parts)	
Weight	Approx. 22.0 kg (48.5 lb.) (excluding cables)	
Product warranty duration	1 year	
Accessories	See p.6.	

Input, output, measurement specifications

(1) Signal source specifications

Source operation method	Bipolar signal source	
Load operating modes	Constant-current (CC)	
Signal superposition terminal	M4 screw terminal block	
Signal superposition terminal ratings	<ul style="list-style-type: none"> • Output power For EC : 400 W (100 W if using an external DC power supply) For FC : 100 W • Output voltage: ± 20 V • Output current: ± 20 A • Line-to-earth voltage: 500 V DC 	
Operating frequency range	DC to 100 kHz	

Interface specifications

(1) LAN interface

Number of ports	1 port
Connector	RJ-45
Cable specifications	STP LAN cable
Rating/method	IEEE 802.3ab compliant
Transmission method	100Base-TX

Accessories specifications

(1) Z7051 LAN hub

Model	C1200-8T-D
Dimensions	Approx. 160 W × 128 H × 30 D mm (6.3W × 5.0H × 1.2 D in.)
Weight	Approx. 0.5 kg (1.1 lb.)
Number of ports	8 ports
Connector	RJ-45 8 pole
Rating/method	IEEE 802.3ab compliant
Transmission method	1000Base-T

(2) Z7038 LAN cable

Dimensions	Cable length : 1000 mm (39.4 in.)
-------------------	-----------------------------------

(3) Z7043 Source Cable

Source Cable	Cable length : 1200 mm (47.2 in.) Terminal profile: M4 to M6
Ratings	Rated current : 20 A

9.4 L1100 Sense Cable

The L1100 is designed specifically for use with the following products:

EA5301-01, EA5301-02, EA5301-03, EA5301-04, EA5301-05, EA5301-06, EA5301-07, EA5301-08

General specifications

Operating environment	Indoor use, pollution degree 2, altitude up to 2000 m (6562 ft.)
Operating temperature and humidity range	0°C to 40°C (32°F to 104°F), 80% RH or less (no condensation)
Storage temperature and humidity range	-10°C to 50°C (14°F to 122°F), 80% RH or less (no condensation)
Dimensions	Full length: Approx. 2215 mm (87.2 in.)
Weight	Approx. 197 g (6.9 oz.)
Maximum input voltage	60 V DC
Maximum rated voltage to earth	60 V DC
Maximum input current	50 mA
Product warranty duration	None (out of scope of coverage)

10 Maintenance and Service

Shipping Precautions

CAUTION

Observe the following when shipping the products:



- Remove the optional equipment.
- When requesting repair, include a description of the malfunction.
- Use the original packaging materials in which the products were delivered, and then place it in an additional box.

Failure to follow this guidance could cause damage to the products during shipment.

10.1 Repairs, Inspections, and Cleaning

WARNING



- Do not attempt to modify, disassemble, or repair the Sense Module or Source Module yourself.

Failure to follow this guidance could cause bodily injury or fire.

Calibration

The calibration interval depends on factors such as the operating conditions and environment. Please determine the appropriate calibration interval based on your operating conditions and environment and have Hioki calibrate the instrument accordingly on a regular basis.

Backing up data

When repairing or calibrating the system, we may initialize it. It is recommended to back up (save/write) data such as the settings and measured data before requesting service.

IMPORTANT

If requesting repair or calibration service from Hioki, please send the following three components together:

- Sense Module
- Source Module
- ALDAS (PC application) USB dongle key

Replaceable parts and service life

Some parts used in the products may deteriorate in characteristics after years of use.

It is recommended to replace these parts regularly to ensure long-term functionality.

To order replacements, please contact your authorized Hioki distributor or reseller.

Part service life varies with the operating environment and frequency of use.

Recommended replacement intervals do not guarantee continuous operation throughout the specified period.

Parts	Service life	Remarks and conditions
EA5301 Sense Module		
Electrolytic capacitor	About 10 years	Requires replacement of the printed circuit boards on which such parts are mounted.
Liquid crystal back-light (half life period of brightness)	About 8 years	If operated 24 hours per day
Fan motor	About 10 years	If operated 24 hours per day
Backup battery	About 10 years	Requires replacement if the time and date are significantly deviated.
Optical insulation element	About 10 years	If operated 24 hours per day
Optical connection cable connector	About 10 years	If operated 24 hours per day
EA5503 Source Module		
Backup battery	About 3 years	

Cleaning

CAUTION

- **Periodically clean the vents.**

Clogged vents could hamper the internal cooling effect of the modules, causing damage to them.



- **To clean the products, wipe them using a soft cloth moistened with water or a neutral detergent.**

Using solvent-containing detergents, such as benzene, alcohol, acetone, ether, ketone, thinner, and gasoline, or wiping the products with excessive force could cause deformation or discoloration.

IMPORTANT

Dirt on the Sense Cable clips should be removed gently with a dry and clean soft cloth or with an industrial-use cotton swab. The presence of any foreign material, such as dirt, on the clips can hinder their ability to make proper contact, thus adversely affecting the measurement results.

Gently wipe the Sense Module's display with a soft and dry cloth.

10.2 Troubleshooting

Should you identify any problems, see “Before returning the products for repair” (p. 117) to address the issues. If further assistance is needed, contact your authorized Hioki distributor or reseller.

Before returning the products for repair

Check the following items.

Issue	Cause	Solution
The modules does not turn on.	The power cords are not connected or not properly connected.	Connect the power cords properly.
The PC application does not start.	The USB dongle key is not connected to the PC.	Connect the USB dongle key to the PC.
Multiple dongle keys detected.	Dongle keys for several different model numbers are connected to the PC simultaneously.	Ensure that only ONE dongle key for the correct application model number is connected to the PC.
The PC cannot connect to the system instruments.	The LAN cable is not connected or not connected properly.	Connect the LAN cable between modules and PC properly.
	The PC's IP address setting is not configured properly.	Configure the PC's IP address properly.
	No current sensor is connected.	Verify that the current sensor is properly connected to CH1 of the Sense Module.
Communications between the PC and modules were interrupted.	The modules have hung.	Reconnect the modules to PC. Restart the system.
Voltage and current measurement values are abnormal. Measured values were unstable.	The Sense Cable, Source Cable, and current sensor are not connected properly.	Verify that the Sense Cable, Source Cable, and current sensor are connected properly. To achieve stable measurements, see “Methods for Stabilizing Measurement” (p. 124).
	The voltage range and current range are not configured properly.	Configure the voltage range and current range properly.
	The current sensor's phase correction setting is not configured properly.	Configure the current sensor's phase correction setting (for the selected current sensor model) properly.
	The measurement signal amplitude is too small.	Check the measurement value, and if the I _{sig} is extremely small, please increase the [Signal Amplitude] value in the measurement condition setting.
	Measurement frequency between 100 kHz to 10 kHz	Create a new measurement setting for this frequency range. For this setting, increase [Signal Amplitude] to a value higher than the one currently used for measurement signal frequencies below 10 kHz.
The PC application was slow, making measurement impossible.	The data is too large because there are many measurement points plotted on the graph.	Data is saved as a CSV file in the project's [DataFiles] folder. For measurements that do not require data comparison, it is recommended to use a separate, new or empty project file.
Measurement was aborted.	The PC went to sleep during measurement.	Configure the PC so that it does not go into sleep-mode.

10.3 Error Messages

- When an error is displayed on the LCD screen, repair is necessary. Contact your authorized Hioki distributor or reseller.
- Starting the system while the lines to be measured are live may damage it or cause an error to be displayed. Always start the system on first and then activate power to the lines to be measured once you have verified that the computer screen displays no errors.

If a measurement system error occurs, a dialog box including an error message will be displayed by the PC application.

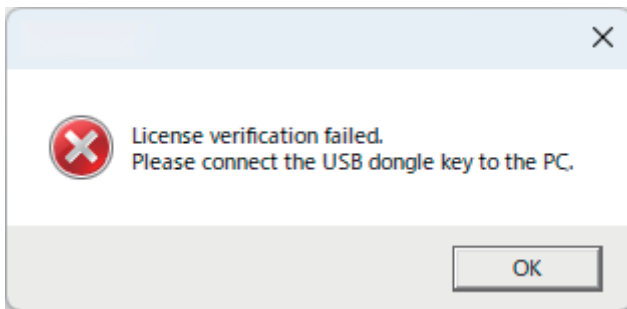

Please address the issue described in the error message.

Message	Solution
The measurement stopped because the measured current exceeded the measurable current range. Please go to the MEASURE tab and set the suitable current range.	Edit the measurement conditions and set the current range to an appropriate value. See "Configuring the Sense Module" (p.57).
The measurement stopped because the measured voltage exceeded the measurable voltage range. Please go to the MEASURE tab and set the suitable voltage range.	Edit the measurement conditions and set the voltage range to an appropriate value. See "Configuring the Sense Module" (p.57).
The measurement stopped due to a communication failure with the device. To restore the connection, please go to the CONNECT tab and click the button under "Connection status".	<ul style="list-style-type: none"> • Check the LAN cable connection between the Sense Module and the Source Module. See "2.6 Connecting LAN Cables" (p.34). • Open the [CONNECT] tab on the main screen and reconnect the modules. See "7.4 Checking the System Connection Status and Reconnection" (p.98).
The measurement stopped because the watchdog protection was activated. To restore the connection, please go to the CONNECT tab and click the button under "Connection status".	
The measurement stopped because the current sensor in the Sense Module was changed. Please go to the MEASURE tab and check the setting for the Sense Module.	<ul style="list-style-type: none"> • Verify that the current sensor is connected to the Sense Module. • Open the [CONNECT] tab on the main screen and reconnect the modules. Once connected, do not disconnect or reconnect the current sensor. See "7.4 Checking the System Connection Status and Reconnection" (p.98). • Edit the measurement conditions and set the current range to an appropriate value. See "Configuring the Sense Module" (p.57).

Message	Solution
The measurement stopped because an over-voltage was detected at the Source Module's signal superposition terminal. Please check if the DUT's voltage is within the rated value.	<ul style="list-style-type: none"> • Verify that the measurement target's DC voltage value does not exceed 20 V. See "Precautions for Use" (p.12), "9 Specifications" (p.103). • Verify that the Source Cable is properly connected to the measurement target. See "2.8 Connecting to the Measurement Target" (p.36).
The measurement stopped because excessive power was detected at the Source Module's signal superposition terminal. Please check if the DUT's voltage is within the rated value.	
The measurement stopped because an over-current was detected at the Source Module's signal superposition terminal. Please check the condition of the Source Cable connection.	
The measurement stopped because an error occurred in the device. Please restart the device.	<ol style="list-style-type: none"> 1. Turn off the Sense Module and Source Module and verify that the following two LAN cables are connected: <ul style="list-style-type: none"> • Between the Sense Module and the Source Module • Between the Source Module and the PC 2. Turn the Sense Module and Source Module back on.
The measurement stopped because the device has entered an abnormal state. Please restart the device.	
The measurement stopped due to an external error in the device. Please restart the device.	
The measurement stopped because the Source Module shut down. Please restart the device.	
The measurement stopped because the Source Module overheated. Please check the Source Module installation and verify that the vent is not obstructed.	Turn off the Source Module and verify that its air vent is not blocked. Ensure that the Source Module is positioned far from nearby objects (see minimum space requirements). After checking these points, leave the Source Module powered on for at least 30 minutes before use to allow the fan to cool it down before use. See "Precautions for Use" (p.12).
The USB dongle key license has been changed. Available license: EA5703 ALDAS-α	Please check if the USB dongle key license is compatible with the project file format.
This project file cannot be opened with the current license. Current license: EA5703 ALDAS-α Project file format: EA570x ALDAS-x	Please select a project file that corresponds to the current USB dongle key license. If there are no compatible files, please create a new project file.
This file is invalid as a project file.	Please select a project file. If there is no project file, please create a new project file.
License verification failed. Please connect the USB dongle key to the PC.	Please check if the USB dongle key is connected to the PC.
Multiple USB dongle keys have been recognized. Please remove any unused USB dongle keys.	Please check the number of USB dongle keys connected to your PC. If you have multiple USB dongle keys connected, please reduce it to one.

10.4 Disposal of the Products

When disposing of the products, remove the lithium batteries and dispose of the batteries in accordance with local regulations. Dispose of all optional accessories in accordance with applicable instructions.

WARNING

- Do not short-circuit the batteries.
- Do not charge the batteries.
- Do not disassemble batteries.
- Do not throw the batteries into fire or expose them to heat.



Failure to follow this guidance could cause the batteries to explode, resulting in bodily injury.



- **Before removing the lithium batteries, first set the switches of the modules to the off position and then remove the power cords and the measurement cables from the measurement target.**
- **Store the removed batteries out of reach of young children.**

CALIFORNIA, USA ONLY
Perchlorate Material - special handling may apply.
See <https://dtsc.ca.gov/perchlorate/>.

11 Appendix

Impedance measurement during DC operation

The system measures the impedance of the measurement target (electrolysis cell or fuel cell) during its operation by using the four-terminal method to measure the voltage and measuring current using a current sensor. The impedance measurement procedure and principles are described below.

Measurement procedure

- 1 AC current superposition:** The AC current I_{sig} is generated by the Source Module (bipolar power supply) and superposition it onto the measurement target.
- 2 Voltage measurement:** The voltage drop V_{sig} due to the impedance of the measurement target is measured by the Sense Module.
- 3 Current measurement:** The AC current I_{sig} flowing to the measurement target is measured by the current sensor.
- 4 Impedance calculation:** The impedance is calculated from the measured voltage V_{sig} and current I_{sig} and the phase different θ using the following formulas:

Real part: $R = V_{sig} / I_{sig} * \cos\theta$

Imaginary part: $X = V_{sig} / I_{sig} * \sin\theta$

Voltage measurement using the four-terminal sensing

In general, electrolysis cells have low resistance, so this system uses a four-terminal method to reduce errors caused by the wiring resistance of the Sense Cable (see Figs. 1 and 2).

During impedance measurement, the AC component I_{sig} is added to the measurement target DC power line by the system's Source Module. At this time, the Sense Module detects the voltage drop V_{sig} caused by the impedance of the measurement target. Due to the high input impedance of the Sense Module's voltage detection circuit, there is no voltage drop across the Sense Cable's wiring resistor R_2 or contact resistor R_3 , since there are no current flows through them. In this way, the four-terminal method measurement eliminates the unwanted effects of the wiring resistance and contact resistance of the Sense Cable.

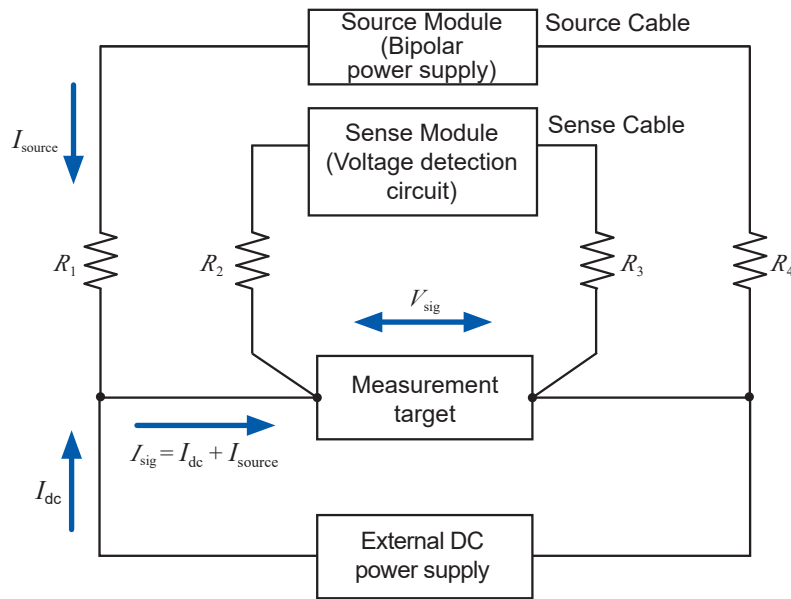

Fig. 1 When using an external DC power supply (measurement target is EC)

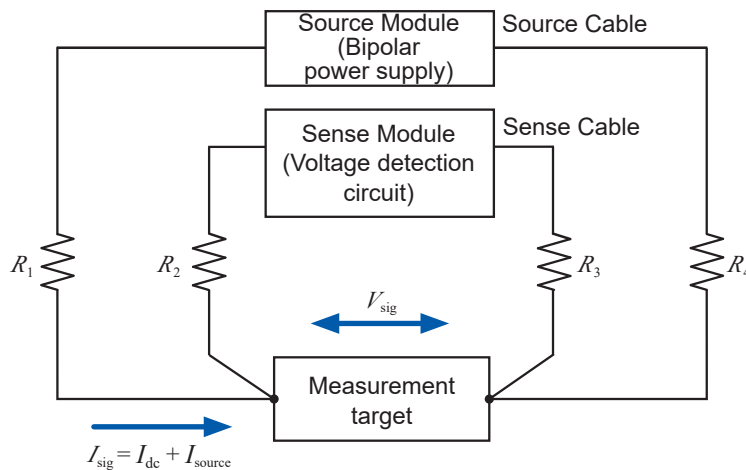

Fig. 2 When using an internal bipolar power supply (measurement target is EC)

Measuring current flowing to the measurement target (electrolysis cell)

When performing impedance measurements on a system operating in a closed circuit with a DC power supply, such as an electrolysis cell, the measuring system sees the measurement target as connected in parallel with the DC power supply. Therefore, in a typical impedance measuring instrument, the measurement current signal I_{AC0} from the measurement signal source is divided into the current flowing to the measurement target, I_{AC1} , and the current flowing to the DC power supply, I_{AC2} . Since the impedance calculation relies on the instrument's applied measurement signal current I_{AC0} , the measured impedance result includes both the measurement target and the DC power supply, making it impossible to measure the impedance of the measurement target alone (Fig. 3). By contrast, the system measures current with a current sensor, allowing it to measure just the AC component I_{sig} flowing to the measurement target and thereby to measure the impedance of the measurement target alone as long as the current sensor is attached to an appropriate path (a path between the Source Cable contact and the measurement target) (Figs. 4 and 5).

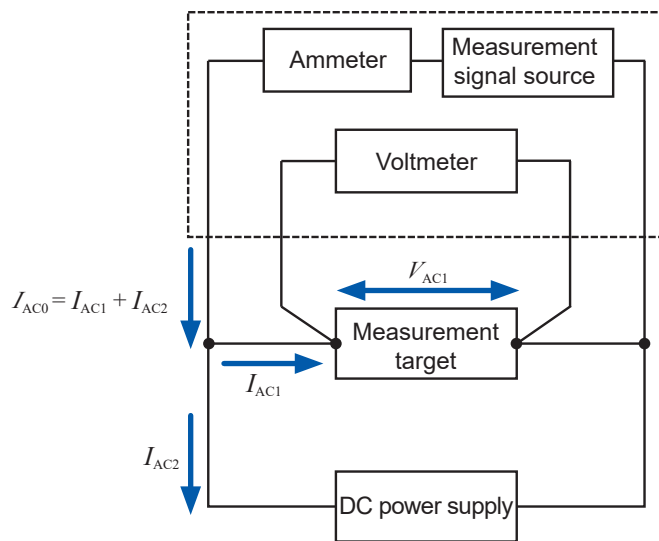

Fig. 3 When using a typical impedance tester

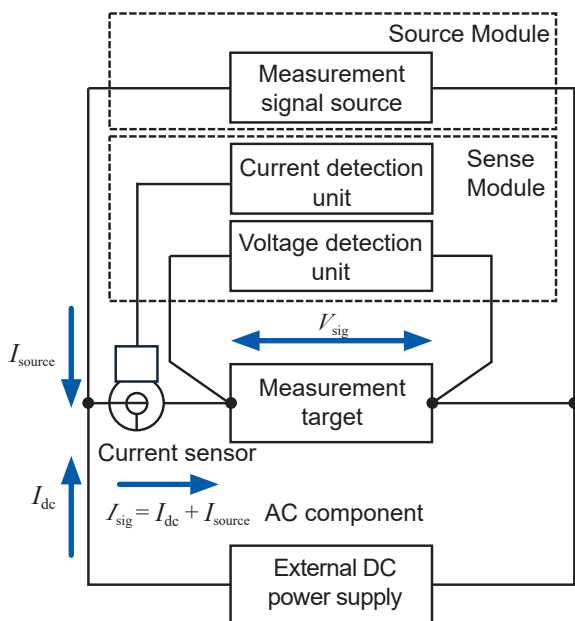

Fig. 4 When using an external DC power supply (measurement target is EC)

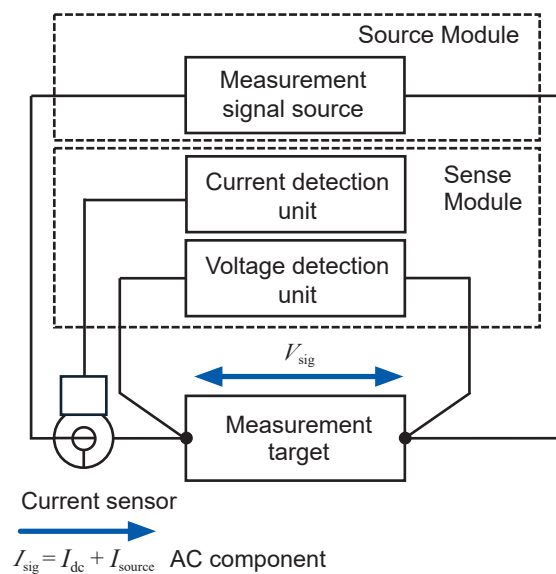

Fig. 5 When using an internal bipolar power supply (measurement target is EC)

Methods for Stabilizing Measurement

Please twist the positive and negative wires of both the Sense and Source Cables as tightly as possible as shown in figure below.

For more details, see Fig. 6.



L1100 Sense Cable

Since the system measures extremely small impedance values using AC, it is susceptible to the effects of electromagnetic induction. The effects of electromagnetic induction occur when the Source-side loop (current superposition side) acts on the Sense-side loop (voltage detection side). The loop area and the distance between the Sense and Source-side loops determined the amount of induced magnetic flux from the Source-side that overlapped the Sense-side loop. Therefore, in order to reduce the effects of electromagnetic induction, it is important to minimize the loop area and to place the Source and Sense Cables as far apart as possible. Specifically, twist the HIGH (positive) and LOW (negative) wires for both the Source and Sense Cable. The wire twist reduces the area of each loop and hence reduces the effects of electromagnetic induction during measurement.

Twisting the cables is also effective as a countermeasure against external inductive noise. Please twist both the Sense and Source Cables tightly and as close as possible to the measurement target.

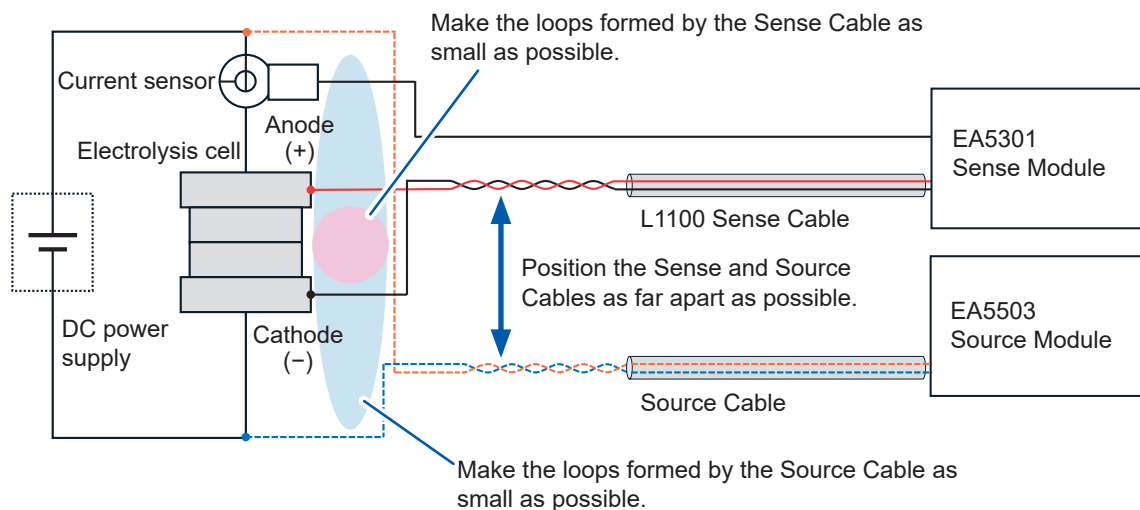

*Twist the cables together right up to the measurement target.

Fig. 6

Index

0ADJ key 18

A

AbsZ_SenseModule1_Ch 97
ALDAS format 91, 97
ArgZ_SenseModule1_Ch 97
Auto Scale 84

C

Cell area size 48, 78
Cell name 78
Cleaning 116
Cole-Cole plots 17
CONFIG 71, 76
CSV file 51
CurrentDensity 81
Current Input 31
Current range 57
Current sensor 31

D

Data 67
Data file 67, 83, 91
DataFiles 60
Data filter 72
Data format 96
Data table 59, 68, 83
Date 97
Date table
 |Z| [mΩ] 68
 Arg(Z) [deg] 68
 Date 68
 Elapsed Time [s] 68
 Frequency [Hz] 68
 Idc [A] 68
 Info 68
 Isig [Ap-p] 68
 No. 68
 R [mΩ] 68
 Vdc [V] 68
 Vsig [Vp-p] 68
 X [mΩ] 68
Default gateway 25
Degaussing 42
Display legend 71
Disposal 120
DMAG 42

E

EIS Mode (Frequency Sweep) 49
ElapsedTime 97
Export I-V data 81

F

Fast 50, 53, 55
File path 81, 96
Formulas (Impedance calculation) 121
Frequency list 52

G

Graph type 71

I

Idc 76, 79, 81
Idc_SenseModule1_Ch 97
I-Impedance plot 77
Impedance graph 59
Impedance real part (Highest frequency) 77, 79, 81
Impedance real part (Lowest frequency) 77, 79, 81
Input channels 19
InstrumentSettings 60
Invert Y-axis 71
IP address 24
I-Power Plot 77
IR-free Plot 76
IR-free voltage 76
Isig_SenseModule1_Ch 97
I-V data 75
I-V graph 48, 59, 75, 76
I-V Plot 76

L

LAN 34
Line 84
Line&Point 84
Logging interval 54, 56
Logging Mode (Fixed Frequency) 49

M

MAC address 21
Main application window 59
MEASURE 61, 63, 65, 87, 88, 89
Measured data filename 50, 53, 55
MeasuredFrequency_SenseModule1_Ch 97
Measurement conditions files 88
Measurement project 44
MeasurementSettings 60, 89
Measurement speed 50, 53, 55
Medium 50, 53, 55
Menu bar 59
Multi-plot format 91

N

Noise reduction.....	50, 53, 55
Nyquist plots	17

O

Ohmic resistance.....	76
-----------------------	----

P

Phase correction function.....	57
Plot Highlight	84
Plot mode	71, 76
Line	71, 76
Line & Point.....	71, 76
Point.....	71, 76
Point	84
Power	77
Power key.....	18
Power supply inlet.....	19
Power switch	20
Probe 1 terminals	19

R

Repairs	115
Reset Axes	84
Rhf.....	77, 79, 81
RJ-45 connector	19
Rlf.....	77, 79, 81
Rohm.....	48, 76, 78
R_SenseModule1_Ch	97

S

Sense Cable	30
Sense Module.....	18
SetFrequency	97
Shipping.....	115
Side menu	59
Signal amplitude	50, 54
Signal frequency.....	54
Single cell	38
Slow.....	50, 53, 55
Snap Shot.....	84
Source Cable.....	33
Source Module	20
Stack.....	38
Subnet mask.....	25
Sweep.....	49

T

Tab list	59
Target information.....	67, 83
Total measurement time	54, 56

U

USB dongle key.....	43
---------------------	----

V

Vdc	76, 79, 81
Vdc_SenseModule1_Ch.....	97
Voltage Input.....	30
Voltage input terminals	19
Voltage range	57
Vsig_SenseModule1_Ch.....	97

X

X-axis axis scale.....	76
linear scale	76
logarithmic scale	76
X-axis item.....	76
Current	76
Current Density	76
X-axis units	71
X_SenseModule1_Ch.....	97

Y

Y-axis item	71
Y-axis units	71

Z

Zero adjustment.....	42
ZView format	91

Warranty Certificate

HIOKI

Model	Serial number	Warranty period One (1) year from date of purchase (___ / ___)
-------	---------------	---

Customer name: _____

Customer address: _____

Important

- Please retain this warranty certificate. Duplicates cannot be reissued.
- Complete the certificate with the model number, serial number, and date of purchase, along with your name and address. The personal information you provide on this form will only be used to provide repair service and information about Hioki products and services.

This document certifies that the product has been inspected and verified to conform to Hioki's standards.

Please contact the place of purchase in the event of a malfunction and provide this document, in which case Hioki will repair or replace the product subject to the warranty terms described below.

Warranty terms

1. The product is guaranteed to operate properly during the warranty period (one [1] year from the date of purchase).
If the date of purchase is unknown, the warranty period is defined as one (1) year from the date (month and year) of manufacture (as indicated by the first four digits of the serial number in YYMM format).
2. If the product came with an AC adapter, the adapter is warranted for one (1) year from the date of purchase.
3. The accuracy of measured values and other data generated by the product is guaranteed as described in the product specifications.
4. In the event that the product or AC adapter malfunctions during its respective warranty period due to a defect of workmanship or materials, Hioki will repair or replace the product or AC adapter free of charge.
5. The following malfunctions and issues are not covered by the warranty and as such are not subject to free repair or replacement:
 - 1. Malfunctions or damage of consumables, parts with a defined service life, etc.
 - 2. Malfunctions or damage of connectors, cables, etc.
 - 3. Malfunctions or damage caused by shipment, dropping, relocation, etc., after purchase of the product
 - 4. Malfunctions or damage caused by inappropriate handling that violates information found in the instruction manual or on precautionary labeling on the product itself
 - 5. Malfunctions or damage caused by a failure to perform maintenance or inspections as required by law or recommended in the instruction manual
 - 6. Malfunctions or damage caused by fire, storms or flooding, earthquakes, lightning, power anomalies (involving voltage, frequency, etc.), war or unrest, contamination with radiation, or other acts of God
 - 7. Damage that is limited to the product's appearance (cosmetic blemishes, deformation of enclosure shape, fading of color, etc.)
 - 8. Other malfunctions or damage for which Hioki is not responsible
 - 9. After disassembly, such as opening the product, has been performed by the customer without permission by Hioki
6. The warranty will be considered invalidated in the following circumstances, in which case Hioki will be unable to perform service such as repair or calibration:
 - 1. If the product has been repaired or modified by a company, entity, or individual other than Hioki
 - 2. If the product has been embedded in another piece of equipment for use in a special application (aerospace, nuclear power, medical use, vehicle control, etc.) without Hioki's having received prior notice
7. If you experience a loss caused by use of the product and Hioki determines that it is responsible for the underlying issue, Hioki will provide compensation in an amount not to exceed the purchase price, with the following exceptions:
 - 1. Secondary damage arising from damage to a measured device or component that was caused by use of the product
 - 2. Damage arising from measurement results provided by the product
 - 3. Damage to a device other than the product that was sustained when connecting the device to the product (including via network connections)
8. Hioki reserves the right to decline to perform repair, calibration, or other service for products for which a certain amount of time has passed since their manufacture, products whose parts have been discontinued, and products that cannot be repaired due to unforeseen circumstances.

HIOKI E. E. CORPORATION

25-10 EN-1

HIOKI
www.hioki.com/



**All regional
contact
information**

HIOKI E.E. CORPORATION
81 Koizumi, Ueda, Nagano 386-1192 Japan

2402 EN

Edited and published by HIOKI E.E. CORPORATION

Printed in Japan

- Contents subject to change without notice.
- This document contains copyrighted content.
- It is prohibited to copy, reproduce, or modify the content of this document without permission.
- Company names, product names, etc. mentioned in this document are trademarks or registered trademarks of their respective companies.

Europe only

- EU declaration of conformity can be downloaded from our website.
- Contact in Europe: HIOKI EUROPE GmbH
Helfmann-Park 2, 65760 Eschborn, Germany hioki@hioki.eu