

HIOKI

3269

Instruction Manual

POWER SUPPLY



Check for the latest edition and other language versions.



Read carefully before use.
Keep for future reference.

EN

Oct. 2024 Revised edition 7
3269A981-07



Contents

Introduction	1
Inspection.....	1
Safety Notes	2
Operating Precautions	5
Chapter 1 Overview	9
1.1 Product Overview	9
1.2 Names of Parts.....	9
Chapter 2 Measurement Procedure	11
2.1 Preparations	11
2.2 Measurement Procedure	12
Chapter 3 Specifications	13
Chapter 4 Maintenance and Service	15
4.1 Cleaning and Service	15

Introduction

Thank you for purchasing the HIOKI Model 3269 Power Supply. To obtain maximum performance from the device, please read this manual first, and keep it handy for future reference.

Product registration

Register your product in order to receive important product information.

<https://www.hioki.com/global/support/myhioki/registration/>



Inspection

When you receive the device, inspect it carefully to ensure that no damage occurred during shipping. If damage is evident, or if it fails to operate according to the specifications, contact your dealer or Hioki representative.

Supplied accessories

- Power cord 1
- Instruction Manual 1

Safety Notes











This device is designed to comply with IEC 61010 Safety Standards, and has been thoroughly tested for safety prior to shipment. However, mishandling during use could result in injury or death, as well as damage to the device. Using the device in a way not described in this manual may negate the provided safety features.



Be certain that you understand the instructions and precautions in the manual before use. We disclaim any responsibility for accidents or injuries not resulting directly from device defects.

This manual contains information and warnings essential for safe operation of the device and for maintaining it in safe operating condition. Before using it, be sure to carefully read the following safety precautions.

Safety Symbols

	In the manual, the  symbol indicates particularly important information that the user should read before using the device.
	The  symbol printed on the device indicates that the user should refer to a corresponding topic in the manual (marked with the  symbol) before using the relevant function.
	indicates a grounding terminal.
	Indicates AC (Alternating Current).
	Indicates the ON side of the power switch.
	Indicates the OFF side of the power switch.

The following symbols in this manual indicate the relative importance of cautions and warnings.

 <u>DANGER</u>	Indicates that incorrect operation presents an extreme hazard that could result in serious injury or death to the user.
 <u>WARNING</u>	Indicates that incorrect operation presents a significant hazard that could result in serious injury or death to the user.
 <u>CAUTION</u>	Indicates that incorrect operation presents a possibility of injury to the user or damage to the device

Measurement categories

To ensure safe operation of measurement devices, IEC 61010 establishes safety standards for various electrical environments, categorized as CAT II to CAT IV, and called measurement categories.

CAT II: Primary electrical circuits in equipment connected to an AC electrical outlet by a power cord (portable tools, household appliances, etc.)

CAT II covers directly measuring electrical outlet receptacles.

CAT III: Primary electrical circuits of heavy equipment (fixed installations) connected directly to the distribution panel, and feeders from the distribution panel to outlets.

CAT IV: The circuit from the service drop to the service entrance, and to the power meter and primary overcurrent protection device (distribution panel).

Using a measurement device in an environment designated with a higher-numbered category than that for which the device is rated could result in a severe accident, and must be carefully avoided.

Use of a measurement instrument that is not CAT-rated in CAT II to CAT IV measurement applications could result in a severe accident, and must be carefully avoided.

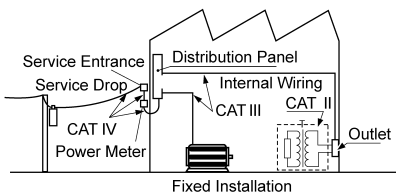

Operating Precautions



Follow these precautions to ensure safe operation and to obtain the full benefits of the various functions.

Ensure that the use of the instrument conforms not only to its specifications but also to the specifications of all products to be used, including accessories.

Before Use

Before using the device for the first time, verify that it operates normally to ensure that no damage occurred during storage or shipping. If you find any damage, contact your dealer or Hioki representative.

! DANGER

- To avoid accidents, when using other measurement devices with this one, observe the usage precautions described for each device.
- When using a measurement instrument that does not provide isolation between its input terminals and chassis or other input terminals, please pay attention to the following points.

If a signal is applied to an input terminal other than that to which the current probe is connected, do not connect the ground-side terminal to any non-ground potential. Otherwise, short-circuit current will flow through the current probe or this device from the ground terminal, which could cause an electrical accident or damage.

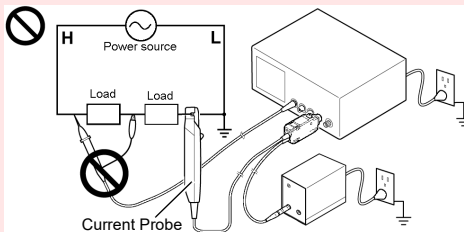
**! WARNING**

To avoid electrical accidents and to maintain the safety specifications of this device, connect the power cord only to a 3-contact (two-conductor + ground) outlet.

 CAUTION

Observe the following to avoid damage to the device.

- Installation and Operating Environment
Between 0 and 40°C (32 and 104°F); 80%RH or less; indoors only.
- Do not store or use the device where it could be exposed to direct sunlight, high temperature or humidity, or condensation. Under such conditions, the device may be damaged and insulation may deteriorate so that it no longer meets specifications.
- This device is not designed to be entirely water- or dust-proof. To avoid damage, do not use it in a wet or dusty environment.
- To avoid damage to the device, protect it from physical shock when transporting and handling. Be especially careful to avoid physical shock from dropping.
- To avoid damaging the power cord, grasp the plug, not the cord, when unplugging it from the power outlet.

Overview

Chapter 1

1.1 Product Overview

This unit is the power supply dedicated to Models 3273-50, 3273, 3274, 3275, and 3276 Clamp on Probe (hereafter referred to as the "current probe"), as well as Models CT6700, CT6701, CT6710 and CT6711 Current Probe. The unit can supply power to up to four current probes.

1.2 Names of Parts

Front view

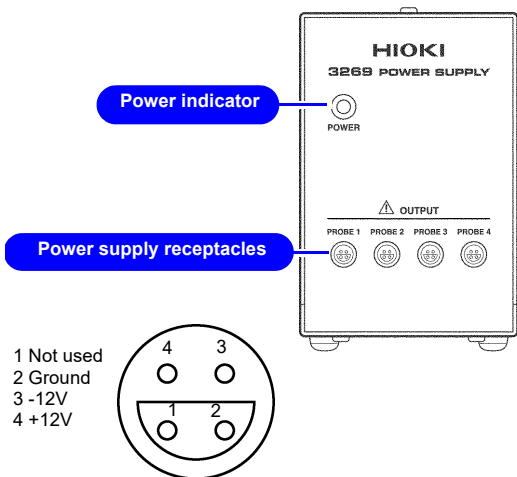

The pin assignment of the receptacles

Rear view

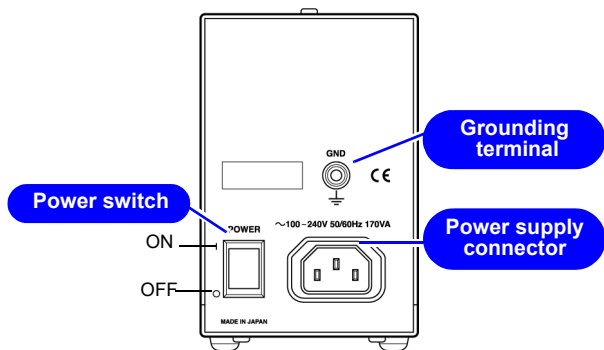

Measurement Procedure

Chapter 2

2.1 Preparations



⚠ DANGER

- To avoid accidents, when using other measurement devices with this one, observe the usage precautions described for each device.
- When using a measurement instrument that does not provide isolation between its input terminals and chassis or other input terminals, please pay attention to the following points.

If a signal is applied to an input terminal other than that to which the current probe is connected, do not connect the ground-side terminal to any non-ground potential. Otherwise, short-circuit current will flow through the current probe or this device from the ground terminal, which could cause an electrical accident or damage.

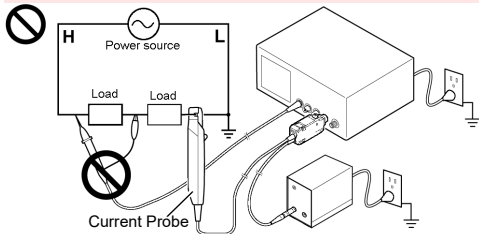



Before turning the device on, make sure the supply voltage matches that indicated on its power connector. Connection to an improper supply voltage may damage the device and present an electrical hazard.

1. Turn the power switch off and connect the power cord.
To avoid electrical accidents and to maintain the safety specifications of this device, connect the power cord only to a 3-contact (two-conductor + ground) outlet.
2. Connect the power plug of the sensor to be used to the power receptacle of the 3269.
3. Turn the 3269 power switch on, and check that the front panel power indicator lights.

2.2 Measurement Procedure

See the 3273-50, 3273, 3274, 3275, 3276, CT6700, CT6701, CT6710, or CT6711 instruction manual.

Specifications

Chapter 3

Product Specifications

Compatible sensors	3273-50, 3273, 3274, 3275, 3276, CT6700, CT6701, CT6710, CT6711
Number of power supply connectors	4
Output voltage	$\pm 12\text{ V} \pm 0.5\text{ V}$
Rated output current	$\pm 2.5\text{ A}$ (sum total of all channels)
Ripple voltage	50 mVp-p or less
Load influence	Within output voltage limits indicated above for current output in the range 0 to $\pm 2.5\text{ A}$
Temperature influence	Within output voltage limits indicated above for ambient temperature in the range 0 to 40°C (32 to 104°F)
Rated supply voltage	100 to 240V AC (50/60Hz) (Voltage fluctuations of $\pm 10\%$ from the rated supply voltage are taken into account.)
Maximum rated power	170 VA
Operating temperature and humidity range	0 to 40°C (32 to 104°F), 80%RH or less (no condensation)
Storage temperature and humidity range	-10 to 50°C (14 to 122°F), 80%RH or less (no condensation)
Location for use	Indoor, altitude up to 2000 m (6562 feet)
Dimensions, Mass	Approx. 80W \times 119H \times 200D mm (3.15"W \times 4.69"H \times 7.87"D) Approx. 1.2 kg (42.3 oz.)
Accessories	Instruction Manual Power cord
Standards applying	Safety EN61010, Pollution Degree 2 EMC EN61326

Memo



Maintenance and Service

Chapter 4

4.1 Cleaning and Service

If the instrument becomes dirty, wipe the instrument clean with a soft cloth slightly moistened with water or a neutral detergent.



Never use solvents such as benzene, alcohol, acetone, ether, ketones, thinners or gasoline. Doing so could deform and discolor the instrument.

- If damage is suspected, contacting your dealer or Hioki representative.
- When sending the device for repair, pack carefully to prevent damage in transit. Include cushioning material so the device cannot move within the package. Be sure to include details of the problem. Hioki cannot be responsible for damage that occurs during shipment.

Memo

Warranty Certificate

HIOKI

Model	Serial number	Warranty period One (1) year from date of purchase (___ / ___)
-------	---------------	---

Customer name: _____

Customer address: _____

Important

- Please retain this warranty certificate. Duplicates cannot be reissued.
- Complete the certificate with the model number, serial number, and date of purchase, along with your name and address. The personal information you provide on this form will only be used to provide repair service and information about Hioki products and services.

This document certifies that the product has been inspected and verified to conform to Hioki's standards. Please contact the place of purchase in the event of a malfunction and provide this document, in which case Hioki will repair or replace the product subject to the warranty terms described below.

Warranty terms

- The product is guaranteed to operate properly during the warranty period (one [1] year from the date of purchase).
If the date of purchase is unknown, the warranty period is defined as one (1) year from the date (month and year) of manufacture (as indicated by the first four digits of the serial number in YYMM format).
- If the product came with an AC adapter, the adapter is warranted for one (1) year from the date of purchase.
- The accuracy of measured values and other data generated by the product is guaranteed as described in the product specifications.
- In the event that the product or AC adapter malfunctions during its respective warranty period due to a defect of workmanship or materials, Hioki will repair or replace the product or AC adapter free of charge.
- The following malfunctions and issues are not covered by the warranty and as such are not subject to free repair or replacement:
 - 1. Malfunctions or damage of consumables, parts with a defined service life, etc.
 - 2. Malfunctions or damage of connectors, cables, etc.
 - 3. Malfunctions or damage caused by shipment, dropping, relocation, etc., after purchase of the product
 - 4. Malfunctions or damage caused by inappropriate handling that violates information found in the instruction manual or on precautionary labeling on the product itself
 - 5. Malfunctions or damage caused by a failure to perform maintenance or inspections as required by law or recommended in the instruction manual
 - 6. Malfunctions or damage caused by fire, storms or flooding, earthquakes, lightning, power anomalies (involving voltage, frequency, etc.), war or unrest, contamination with radiation, or other acts of God
 - 7. Damage that is limited to the product's appearance (cosmetic blemishes, deformation of enclosure shape, fading of color, etc.)
 - 8. Other malfunctions or damage for which Hioki is not responsible
- The warranty will be considered invalidated in the following circumstances, in which case Hioki will be unable to perform service such as repair or calibration:
 - 1. If the product has been repaired or modified by a company, entity, or individual other than Hioki
 - 2. If the product has been embedded in another piece of equipment for use in a special application (aerospace, nuclear power, medical use, vehicle control, etc.) without Hioki's having received prior notice
- If you experience a loss caused by use of the product and Hioki determines that it is responsible for the underlying issue, Hioki will provide compensation in an amount not to exceed the purchase price, with the following exceptions:
 - 1. Secondary damage arising from damage to a measured device or component that was caused by use of the product
 - 2. Damage arising from measurement results provided by the product
 - 3. Damage to a device other than the product that was sustained when connecting the device to the product (including via network connections)
- Hioki reserves the right to decline to perform repair, calibration, or other service for products for which a certain amount of time has passed since their manufacture, products whose parts have been discontinued, and products that cannot be repaired due to unforeseen circumstances.

HIOKI E.E. CORPORATION

<http://www.hioki.com>

18-07 EN-1

HIOKI

www.hioki.com/



**All regional
contact
information**

HIOKI E.E. CORPORATION

81 Koizumi, Ueda, Nagano 386-1192 Japan

2402 EN

Edited and published by HIOKI E.E. CORPORATION

Printed in Japan

- Contents subject to change without notice.
- This document contains copyrighted content.
- It is prohibited to copy, reproduce, or modify the content of this document without permission.
- Company names, product names, etc. mentioned in this document are trademarks or registered trademarks of their respective companies.

Europe only

• EU declaration of conformity can be downloaded from our website.

• Contact in Europe: HIOKI EUROPE GmbH
Helfmann-Park 2, 65760 Eschborn, Germany

hioki@hioki.eu